

From the collection of the

o PreLinger
Library

A decorative graphic consisting of various lowercase letters scattered around the main title. The letters are in two colors: yellow and red. Some letters are positioned above the 'Pre' part of the title, some below the 'Linger' part, and some below the 'Library' part. The letters include 'j', 'y', 'z', 'n', 'm', 'k', 'o', 'u', 'v', 'q', 'a', 'b', 't', 's', 'w', 'p', 'd', 'r', 'f', 'g', 'h', 'i', 'l', 'm', 'n', 'o', 'p', 'q', 'r', 's', 't', 'u', 'v', 'w', 'x', 'y', 'z'.

San Francisco, California
2006

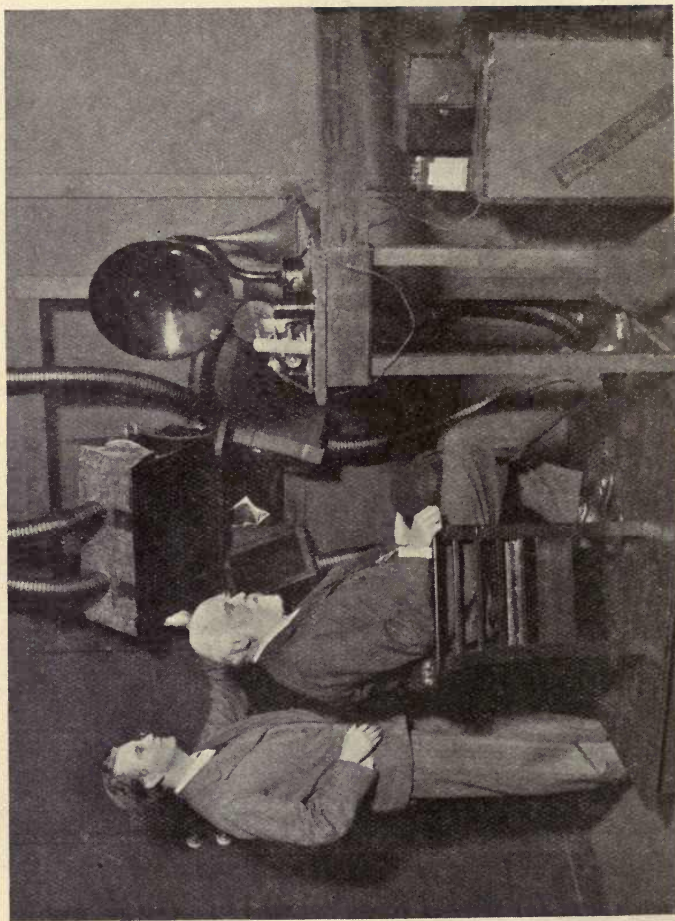
27.52

~~427~~
996

JOHN V. L. HOGAN
41 PARK ROW
NEW YORK

OCT 20 1928

PRACTICAL TELEVISION



Sir Oliver Lodge "Seeing-in."

[Frontispiece.

PRACTICAL TELEVISION

BY
E. T. LARNER

(ENGINEERING DEPARTMENT, GENERAL POST OFFICE, LONDON; ASSOCIATE OF
THE INSTITUTION OF ELECTRICAL ENGINEERS; FORMERLY LECTURER IN
ELECTRICAL ENGINEERING AT THE LONDON COUNTY COUNCIL
HACKNEY INSTITUTE)
AUTHOR OF "RADIO AND HIGH-FREQUENCY CURRENTS,"
"ALTERNATING CURRENTS," TC.

WITH A FOREWORD BY
JOHN L. BAIRD

NEW YORK
D. VAN NOSTRAND COMPANY, INC.
EIGHT WARREN STREET
1928

THE
TELEVISION

Printed in Great Britain

FOREWORD

THE present generation has seen the birth and growth of wireless telegraphy from a scientific novelty to a vast industry.

From the first experiments of Hertz in 1888 to the present day covers a period of forty years, and during those forty years it can be said that the whole outlook of the man in the street towards science has undergone a fundamental change. We have at the present time a great public interested, and intelligently interested, in scientific subjects, and a new literature has sprung up catering for this body of people. This literature deals almost exclusively with the many branches of wireless and depends for its appeal upon the listener-in. If no other benefit has been conferred upon humanity by the development of radio communication, the introduction of this interest in science to a public which had hitherto been apathetic would in itself be no small benefit.

The Shorter Catechism defines man's chief end as the glorification of God, the American Constitution more prosaically defines it as the pursuit of happiness, while in these days we might prefer to describe it as the pursuit of truth. Where better can we seek for truth than in scientific research? Sport, Business,

Art, Music, and all the other avenues into which man directs his energies, are tainted with commercialism, self-interest, passion, and emotion.

In introducing the public to science, wireless broadcasting has somewhat regrettably, but inevitably, given a preponderating, in fact an almost exclusive, interest to the study of phenomena connected with high-frequency electrical oscillations. Other branches of science unconnected with wireless have been almost completely ignored. To-day it would be difficult to find a household in which at least one member could not give a lucid distinction between a volt and an ampere, but the same state of affairs does not by any means prevail regarding optics, chemistry, and mechanics, and the young gentlemen who are so familiar with volts, amperes, microfarads, and henries are frequently totally ignorant of the most fundamental principles of those other branches of science, and would, for example, be unable to define the functions of a lens or a prism. Television, unlike Wireless, covers optics, chemistry, mechanics, in fact every branch of science, and introduces its devotee, not only to physics, but also to physiology, demanding, as it does, a knowledge of the physiology and psychology of vision; indeed, but for a purely physiological phenomenon, retentivity of vision, Television, as we know it to-day, would be an impossibility, and a study of the human eye is essential to a clear understanding of the principles underlying the electrical transmission of visual images.

Photo-electricity is another branch of the subject which is of intense interest and importance. We are still in ignorance as to the true nature of light. In some respects it behaves as if it were a corpuscular emission; other phenomena would appear to prove conclusively that it is a form of wave motion. The key to the elucidation of this outstanding problem may well be found in the study of photo-electric phenomena.

In the present work the author deals very fully with the fundamental principles from which Television was developed, and deals with them in such a way as to interest the general reader without departing from strict scientific accuracy. It is to be hoped that the book will prove of the greatest assistance to those who are commencing the study of a subject which perhaps offers to the young scientific worker the most promising prospects of any avenue of research.

J. L. B.

1928.

CONTENTS

CHAPTER I

	PAGE
INTRODUCTORY	17
The Problem of Television: First Stages of Solution: Preliminary Lines of Research: The Eye as a Model: Persistence of Vision: The Principle of the Telephone as a Guide: Finding an Artificial Eye.	

CHAPTER II

HISTORICAL	35
The Pioneers: The Advent of Selenium: Employment of Thermo-electricity: Wireless Photography: Cathode-ray Systems: Korn's Experiments: The Poulsen-Korn System: The Transmission of Pictures over Telephone Lines: Pictures by Wire: Knudsen's Experiments in Radio-photography: Thorne Baker Apparatus for Wireless: Transatlantic Radio Pictures.	

CHAPTER III

SELENIUM AND THE SELENIUM CELL	63
Selenium: Make-up of the Selenium Cell: Performance and Behaviour: Inertia and Lag.	

CHAPTER IV

PHOTO-ELECTRICITY AND THE PHOTO-ELECTRIC CELL	74
General Description: The Electrodes, Anode and Cathode: The Two Classes of Photo-electric Cell: Potassium in Vacuum Cell of the G.E.C.: The G.E.C.'s Potassium in Argon Cell: The Cambridge Instrument Co.'s Potassium in Helium Cell: Sensitivity of the Photo-electric Cell: Variation of Current with Voltage: Amplifying the Photo-electric Current: Disadvantages of the Photo-electric Cell: Zworykin's Cell.	

CHAPTER V

CONTINENTAL AND AMERICAN RESEARCHES	91
Ernest Ruhmer's Attempts: Rynoux and Fournier: The Problem from a New Angle: Szczepanik's Apparatus: MM. Belin and Holweck and the Cathode-ray: M. Dauvillier's Apparatus: Mihaly's "Telehor": Jenkins' Television of Shadowgraphs: Jenkins' Prismatic Ring: The Moore Lamp: Method of Operation: Dr. Alexanderson's Experiments.	

	PAGE
CHAPTER VI	
RESEARCHES WITH THE CATHODE-RAYS	109
Historical: The Phenomena of the Discharge Tube: Properties and Characteristics of Cathode Rays: The Cathode-ray Oscillograph: Rosing's Attempts with the Cathode-ray: Mr. Campbell Swinton's Suggestion.	
CHAPTER VII	
IMAGES AND THEIR FORMATION	119
Light Sources and Illuminants: How Light Travels: Hertz' Experiments in Electro-magnetic Radiation: Light Waves: Lights and Shadows: Refraction of Light Rays: Images: Mirrors and Lenses.	
CHAPTER VIII	
THE BAIRD TELEVISOR	132
Outline of Principles Employed in Baird's System: Original Apparatus: (a) Transmitting End; (b) Receiving End.	
CHAPTER IX	
TELEVISION TECHNIQUE	147
Present State of the Art: Modern Requisites and Procedure: Illuminants: Synchronism: Television Radio Equipment: Short Wave Wireless Television: The Special Aerials: Transmitting and Receiving Circuits: Transatlantic Television: Its Possibilities.	
CHAPTER X	
RECENT DEVELOPMENTS	160
Invisible Rays: Properties of Infra-red Rays: Vision in Darkness: The Noctovisor: The Phonovisor: Long Distance Television.	
APPENDIX	172
INDEX	173

LIST OF ILLUSTRATIONS

FIG.	PAGE
Sir Oliver Lodge "Seeing in" <i>Frontispiece</i>	
1. Specimen of Picture transmitted over Telephone Lines <i>facing</i>	20
2. Specimen of Transatlantic Radio Picture „	20
3. An Early Specimen of Television Picture „	22
4(a) & (b). Comparison of Eye with Photo Camera	22
5. A Vertical Section of the Human Eye	23
6. Illustrating Persistence of Impressions	26
7. Another Illustration of Visual Persistence	27
8. The Similarity of Telephone and Television Methods	29
9. Bain's Chemical Recorder	36
10. Bakewell's Apparatus	37
11. Edison's and Vavin and Fribourg's Apparatus	38
12. Mimault's Method and the Arrangement for Signalling the letter "T"	39
13. Showing how a Portrait may be Drawn by means of Lines of Varying Width <i>facing</i>	39
14. Senlecq's Apparatus	41
15. Carey's Apparatus	43
16. Bernouchi's Method	45
17. Diagram of Korn's Circuit	46
18. Arrangement of Korn's Apparatus	47
19. Diagrammatic View of Einthoven String Galvanometer <i>facing</i>	48
20. Pointolite Lamp „	48
21. Schematic Diagram of Sending End of Apparatus	51
22. Schematic Diagram of Receiving End of Apparatus	51
23. Knudsen's original Receiving Circuit for Radio Photography	54
24. Knudsen's Transmitter Circuit	54
25. Diagrammatic Sketch of Ranger's Transmitter	58

FIG.		PAGE
26.	Diagrammatic Sketch of Ranger's Receiver	58
27.	Specimen of Print sent by Radio <i>facing</i>	59
28.	Specimen of Print sent by Radio "	59
29.	Mr. Baird's original Transmitting Apparatus	61
30.	Mr. Baird's original Receiving Apparatus	61
31.	Illustrating Construction of early form of Selenium Cell	69
32.	An early form of Selenium Cell	69
33.	Modern form of Selenium Cell (unmounted)	66
34.	Modern form of Selenium Cell (mounted)	69
35.	General Curve showing Inertia or Lag of a Selenium Cell	71
36.	General Curve for Behaviour of a Selenium Cell	71
37.	Glass Bulb of typical Photo-electric Cell	75
38.	Langmuir's Mercury Vapour Pump <i>facing</i>	75
39.	Internal Construction of Langmuir's Mercury Vapour Pump <i>facing</i>	75
40.	The Cambridge Instrument Co.'s Photo-electric Cell "	76
41.	The Cambridge Instrument Co.'s Photo-electric Cell, Internal Construction <i>facing</i>	76
42.	General Electric Co.'s Vacuum Type Photo-electric Cell	79
43.	General Electric Co.'s New Vacuum Type Photo-electric Cell	79
44.	General Electric Co.'s Gas-filled Type Photo-electric Cell	80
45.	Variation of Current with Voltage in a G.E.C. Vacuum Cell	83
46.	Current-voltage Curve of Cambridge Instrument Co.'s Cell	83
47.	Current Wave-length Curve for an Average Cell	84
48.	Connections for measuring Photo-electric Current	85
49.	Diagram of Connections for Amplifying Photo-electric Current	86
50.	Zworykin's Cell	89
51.	Szczepanik's Television Apparatus	94
52.	Apparatus of MM. Belin and Holweck	95
53.	Explaining the Principle of Mihaly's "Telehor"	97
54.	The "Telehor" Transmitter Circuit	98
55.	The "Telehor" Receiving Circuit	98

LIST OF ILLUSTRATIONS

xiii

FIG.		PAGE
56.	The Tuning-fork Interrupter	99
57.	La Cour's "Phonic Drum"	99
58.	Principle of Working employed by Jenkins and Moore .	100
59.	Jenkins' Prismatic Disc	102
60.	The Moore Lamp	103
61.	Illustrating how Beam of Light traces out Lines across Screen	104
62.	Alexanderson's Apparatus	107
63.	Electric Discharge in an Exhausted Tube	110
64.	Deflecting Cathode-rays by Magnet	111
65.	The Cathode-ray Oscillograph <i>facing</i>	112
66.	Rosing's Apparatus	114
67.	Proposed Construction for using Cathode-rays in Tele- vision (Transmitting Apparatus)	115
68.	Proposed Construction for using Cathode-rays in Tele- vision (Receiving Apparatus)	116
69.	Wave-length	124
70.	A Shadow Cone	124
71.	Umbral and Penumbral Shadow Cones	125
72.	Incident and Refracted Ray	126
73.	Convex Mirror	127
74.	Concave Mirror	127
75.	Image formed by a Convex Mirror	128
76.	Image formed by a Concave Mirror	128
77.	Illustrating Refraction of Light	129
78.	Types of Lenses	130
79.	Diagrammatic Sketch of Transmitting Arrangements .	134
80.	Lens Disc	135
81.	Slotted Disc	135
82.	Spiral-slotted Disc	135
83.	Diagrammatic Sketch of Receiving Apparatus	137
84.	The Neon Lamp <i>facing</i>	138
85.	Baird's Optical Lever Principle	139
86.	Arrangement with Two or more Photo-electric Cells .	141
87.	Diagrammatic View of Arrangement in Fig. 86	142
88.	Baird's Method of employing Plurality of Light Sources .	142

FIG.		PAGE
89	Baird's System of Exploring the Object to be Transmitted by a Single Point of Intense Light	145
90.	Syntonic Wireless with Carborundum Detector	148
91.	Bank of Lamps	<i>facing</i> 150
92.	Short Wave Transmitting Aerial	155
93.	Transmitting Radio Circuit	156
94.	Spectrum as Produced by a Prism	162
95.	Radiation Energy Curve for the Spectrum	163
96.	Mr. Baird testing Fog-penetrating Power of his "Nocto- visor"	<i>facing</i> 166
97.	Television between London and Glasgow	170

TABLES

Table of Wave-lengths	32
Table Showing Sensitivity of Photo-electric Cell to the Rays of Different Coloured Light	164

NOTE

THE author gladly acknowledges his obligations to the Cambridge Instrument Company, Ltd., and to the General Electric Company, Ltd. (of London), for much useful information freely offered, including the loan of electros and sketches, viz. Figs. 40, 41, 46, 47, and 48 from the Cambridge Instrument Company, Ltd., and Figs. 42, 43, 44, 45, and 84 from the General Electric Company, Ltd. Also to Messrs. Marconi's Wireless Telegraph Company, Ltd., for copies of pictures transmitted by radio, Figs. 2, 29, and 30; to the American Telephone and Telegraph Company and the *Bell System Technical Journal* (per Mr. H. E. Shreeve) for the use of illustrations given in Figs. 1, 13, 21, and 22; to the Editor of the *Wireless World* for permission to reproduce Figs. 53, 54, 55, 56, 57, 62, 67, and 68; to the Editor of *English and Amateur Mechanics* for permission to reproduce Figs. 14 and 15; to the Edison-Swan Electric Company, Ltd., for the loan of block, Fig. 20; to the British Thomson-Houston Company, Ltd., for the loan of blocks, Figs. 38 and 39; to the Standard Telephones and Cables, Ltd., for photograph, Fig. 65.

PRACTICAL TELEVISION

CHAPTER I

INTRODUCTORY

SIGHT is, beyond doubt, of all the senses with which man is endowed the medium through which he has gathered and continues to gather most of his ideas and knowledge of his surroundings and the universe. Hearing is almost equal in importance, but the general consensus of opinion would undoubtedly be in favour of sight, for by it the mind is stimulated to a greater degree than from any one of the other senses. Moreover, facts can be impressed on the mind by sight much more readily than by the spoken or written word. Actual seeing rivets the attention immediately, and there is a tacit comprehension of what is unfolded to view which is occluded by the barriers of language.

From the earliest times man has striven to improve his means of visualising objects and things; especially those things that are normally altogether unseen. There is little doubt that the use of the magnifying glass as an optical instrument was known to the ancient Greeks. Later, we know that a mechanical arrangement of lenses for seeing distant objects, known as the

telescope, was constructed. Its actual date of discovery is disputed, but as an astronomical instrument it may be said to date from the time of Galileo, who by its aid was able to see the spots on the sun, the mountains of the moon, and Jupiter's satellites.

From this stage to the next, when a device for utilising electricity in order that man might understand and see by signs what was happening at remote spots invisible to the eye, a considerable span of years elapsed, but succeeding developments brought forth the transmission of drawings and pictures which may be regarded as the "shadows of coming events cast before." To-day we have the actual seeing of persons and events rendered possible by means of apparatus that would have astounded the contemporaries of Galileo.

Tracing the development of the art as the various stages were reached, although very interesting, does not come strictly within the scope of this book, but for the benefit of those readers who desire to have for reference a short account of television research a summary of the early attempts will be given in the next chapter.

The Problem of Television.

The word television has now come into general use in the English language as a term descriptive of the instantaneous transmission of images of objects or scenes by telegraphy, either by wire or by wireless.

The transmission of photographs by telegraphy is

often confused with television, and it would be well at the outset to distinguish clearly between the two subjects. The telegraphic transmission of *photographs* is properly described as *phototelegraphy*, while the transmission of actual objects and scenes without the intervention of photography constitutes *television*. The transmission of sixteen photographs per second gives a moving picture at the receiving station, but this is effected by means of a film or kinematograph transmission and does not come under the heading of television, but under that of telekinematography.

In this book we propose to deal only with television, as although there is a certain connection between phototelegraphy and television, the methods at present used in phototelegraphy are not applicable to television.

The discovery of means whereby we can see distant objects and scenes outside the range of normal vision and without regard to intervening objects or other obstructions, such as, for instance, the curvature of the earth, has long been the ultimate aim of the scientific inventor. The application of electricity to seeing by wireless has occupied the minds of quite a number of experimenters who foresee in the wireless field of research the discovery of a new wonder that will not only interest and excite the imagination of the public, but will also have commercial potentialities. If it is possible to transmit sound and to talk over the ocean without the aid of any material conductor like copper wire, why should not sight be rendered possible in a similar manner? If electric waves can reproduce

sound and speech in any part of America from a transmitting centre in Europe, why cannot they be made to reproduce rays of light, that is vision, on the other side of the Atlantic by the adoption of similar suitable means ?

First Stages of Solution.

The practical feasibility of such a problem having been duly recognised, it has been attacked in a variety of ways, the chief of which has been the pioneer work of the successful transmission of photographs both by wire and wireless — phototelegraphy as it is called.

Now there are no practical difficulties in the way of transmitting a photograph or transmitting views of actual objects by means of phototelegraphy over a considerable distance either with or without wires and reproducing a photograph or picture at the distance station which bears an exact likeness to the original, so that the achievement of successful phototelegraphy is certainly a step in the right direction towards radio vision.

A specimen picture transmitted over telephone lines by this means is shown in Fig. 1. A radio picture transmitted across the Atlantic without wires by the same means is shown in Fig. 2. It will be observed that more detail is possible with the former.

Several methods of phototelegraphy are already in good working order at the present day, notably those invented by M. Belin, Professor Korn, and others, and



FIG. 1.—Specimen of Photograph received over Telephone Lines by the American Telephone and Telegraph Company.

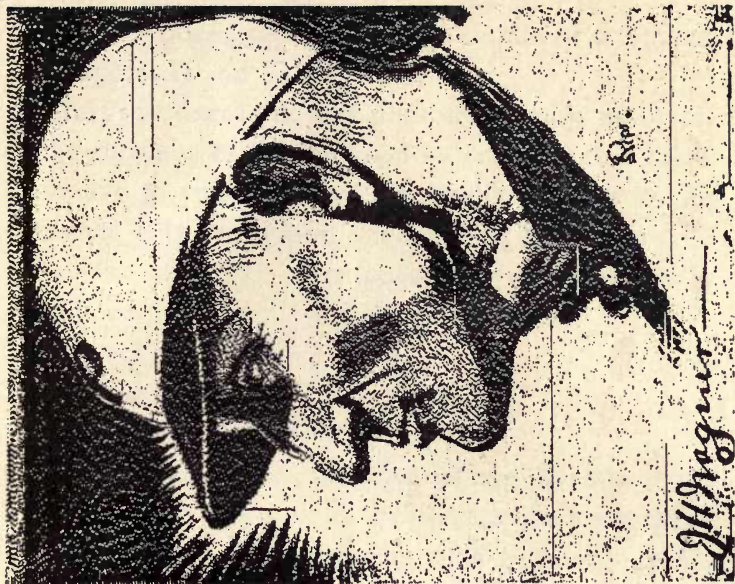


FIG. 2.—Specimen of a Drawing of a Baseball Player transmitted between New York and London by Radio.

[To face page 20.



short descriptions of the methods employed are given in Chapters II and V.

The great drawback with phototelegraphy, however, is the slowness of transmission—a small picture takes from five to twenty minutes to transmit, due to the fact that only small portions of the pictures can be taken one after the other until the whole picture is completed.

Preliminary Lines of Research.

To obtain television, the scientist and inventor must not stop at this stage, since the process of transmission is tantamount to picture transmission and not wireless sight of objects far away and out of range after the manner of seeing objects within the range of our eyes. The slowness of transmission, moreover, is accentuated where phototelegraphy is concerned in the additional time taken to develop and fix the light-sensitive films. By increasing the speed of this method, however, and making the transmission instantaneous, television in its true sense has been accomplished.

It is along the lines of this character, then, but with the object of finding out how to throw the image on to a screen giving life-size pictures similar to those seen at cinemas, that investigators have so far proceeded towards their goal. They have therefore directed their attention to the study of ways and means whereby existing appliances, both natural and artificial, could be copied for the purpose of bringing out the

desired results. One of the very first fruits of their endeavours is given in Fig. 3.

Now in all inventions that come under the category of aids to physical faculties it has always been the practice of inventors to study first the methods nature provides—*e.g.* the lens of the eye is copied in the

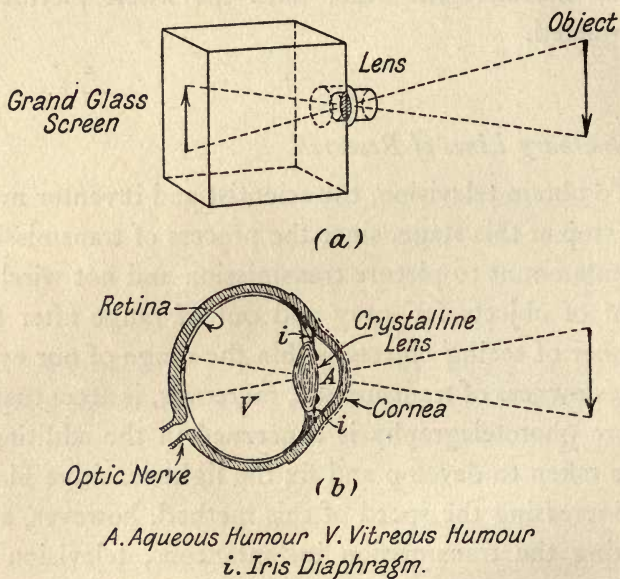


FIG. 4.—Comparison of Eye with Photo Camera.

telescope ; the action of the drum of the ear is imitated in the construction of telephone receiver, etc. Nature has also been copied in the conquest of the air. Many years were spent by various experimenters in attempting to fly, but it was not until the careful study of the flying of birds had been undertaken that the problem of flight was solved. So, too, in wireless seeing by



FIG. 3.—One of the first Pictures received by Baird's
Television Apparatus.

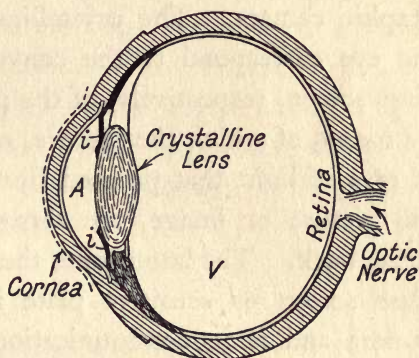
[To face page 22.]

considering and copying the marvellous mechanism of the eye the possibility of television is achieved.

The Eye as a Model.

It will be well at the outset, therefore, to glance briefly at this remarkable piece of nature's mechanism, since nature's method of solving her television problem has formed the basis of many television methods.

The eye is essentially an optical instrument, and its principle of construction and working may be followed more intelligently perhaps by making comparison with an



- A. Aqueous Humour*
V. Vitreous Humour
i. Iris Diaphragm

FIG. 5.—Vertical Section of the Eye.
 Front to back.

artificial eye like the photographic camera. Compare Fig. 4 (*a*) and (*b*).

This comparison may be applied more closely by considering the construction of the eye in greater detail. In the vertical section of the eye front to back shown in Fig. 5 we have the *cornea* in front, behind which is the anterior chamber filled with a watery fluid called the "aqueous humour" and immediately behind which is the most important part

perhaps, the *crystalline lens*. Behind the latter in the posterior chamber is the "vitreous humour"—a watery fluid similar to the aqueous humour. The walls of the eyeball consist of three coats, the inner coat is called the "*retina*," a delicate membrane which is really a fine network expansion of the optic nerve.

The structure of the eye may be likened to a photographic camera. The crystalline lens and retina of the eye correspond to the convex lens and ground-glass screen, respectively, of the photographic camera, by means of which the picture, or rather the millions of rays of light that proceed from the object to form the picture or image, are thrown on to the retina at the back. The latter takes the place of the ground-glass screen or sensitive plate in the photographic camera and is in communication with the brain by means of numerous sensitive nerve structures.

A clue to the solution of the problem is found in a close examination of the screen, which is called the retina. The surface of this is found to consist of a mosaic made up of an enormous number of hexagonal cells, and each of these cells is directly connected to the brain by a number of nerve filaments along which travel impulses which are dependent upon the intensity of the light falling upon the hexagonal cells. Exactly how these impulses are generated is not at present fully understood, but they are almost certainly due to the presence of a light-sensitive substance named "visual purple," which flows through the hexagonal cells. The images which we see are thus built up of an

extremely fine mosaic of microscopic hexagons of varying degrees of light and shade. The number of these hexagonal cells is enormous. In a normal human eye there are several millions.

This arrangement has been imitated by devising apparatus whereby rays of light of varying brightness when reflected from an object are projected, through the intermediary of an electric current, on to a screen at the receiving station. The variations in the intensity of illumination of the object are controlled by means of a light-sensitive cell which sends out variations of electric current intensity to correspond with the light variations.

Persistence of Vision.

While on the subject of the human eye it may not be out of place to refer to the fact that the retina continues to feel the effects of the light rays after the object that caused the sensation of sight has been removed. This phenomenon is called *the persistence of impressions* or *visual persistence*—the impressions lasting approximately for one-tenth of a second. Examples of this are quite familiar to us all and advantage of the phenomenon is taken in television. Thus a glowing match-end when swung round in a circle appears as a bright ring of light, and not as a single bright spot changing its position every moment. Also the colours of a rapidly rotating disc that has several different colours blend into one colour, and an alternating current supply of electricity gives a steady

light, the fluctuations of light that are actually taking place being too rapid for the eye to detect them. The reader will no doubt call to mind many other similar

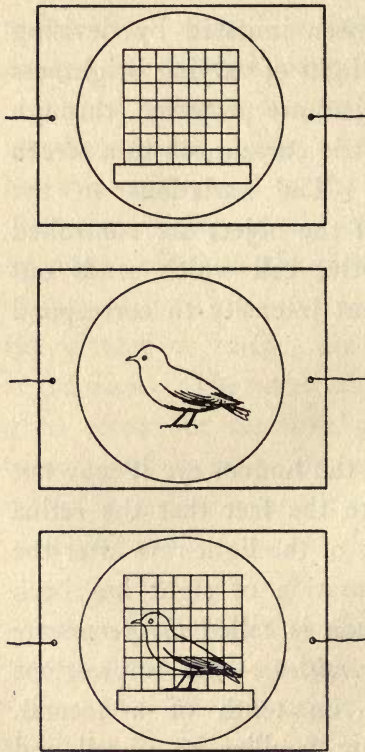


FIG. 6.—Illustrating Persistence of Impressions.

examples and illustrations that serve to show how easily the eye may be deceived.

The persistence of impressions in the eye last quite a perceptible time, the images of the brightly illuminated objects if the latter are shown or presented for only one-thousandth of a second remain in the eye for a whole tenth of a second before they die away. If, then, a second impression is presented to the eye before the first has died away, the effect will be the same as that of seeing both at once. An experimental

verification of this principle may be carried out by drawing on one side of a white card the outline of a bird-cage and on the other side a bird. If the card be held by means of two strings as shown in Fig. 6 and then twisted or twirled by blowing on the card so

as to cause rotation, the effect will show a bird in the cage. Again, if a disc with a number of small holes perforated in it be placed in the slide of a lantern, the holes as separate spots of light will be seen on the screen; but if the disc is rotated rapidly upon a pin fixed at its centre, each little hole is no longer seen separately, but there is a continuous luminous line shown on the screen (Fig. 7). The eye, fortunately for the success of television, has a "time lag," and

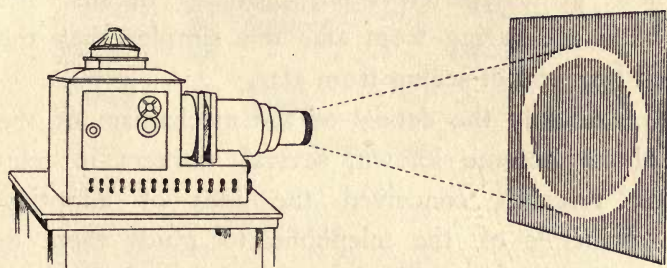


FIG. 7.—Another Illustration of Visual Persistence.

the images therefore need not actually be transmitted instantaneously; when they are transmitted at the rate of eight per second, the transmission appears to the eye to be instantaneous.

In television eight images per second are transmitted; these images, it should be clearly understood, are not photographs, but images of the actual living scene. The transmission of eight photographs per second would not achieve television, but would be the transmission of a cinematograph film, or telecinematography.

The Principle of the Telephone as a Guide.

While the marvellous mechanism of the human eye was being made the subject of study with a view to the construction of an artificial eye that would convey vision over distances outside the ranges hitherto obtainable, Graham Bell and others were at work on their methods of attaining the desired end. Graham Bell, however, as we know, perfected the telephone without achieving television, probably because the problem of hearing from afar was simpler than the allied problem of seeing from afar.

Immediately the details of the mechanism of the telephone became known, several workers in television research conceived the idea of adopting the principle of the telephone to guide them in their experiments. Hoping to solve the problem, scientists and inventors proceeded to imitate the electrical devices of the telephone transmitter and receiver.

They maintained that just as sound waves when they impinge on the sensitive transmitter (carbon granules) of the telephone, thereby altering the electrical resistance with each note and varying the electric current to be transmitted, so the different variations of light and shade of an object by means of a light-sensitive cell could be transformed into varying electric currents that could be transmitted to a distance; and just as the currents received by the telephone receiver cause the diaphragm to set up vibrations producing sounds in the ear that

are faithful reproductions of the transmitted notes, so, in television, the transmitted electrical currents could at the receiving end vary the rays given off by a source of light and reproduce a photograph or picture of the object or scene transmitted.

By comparing the two diagrams in Fig. 8 which

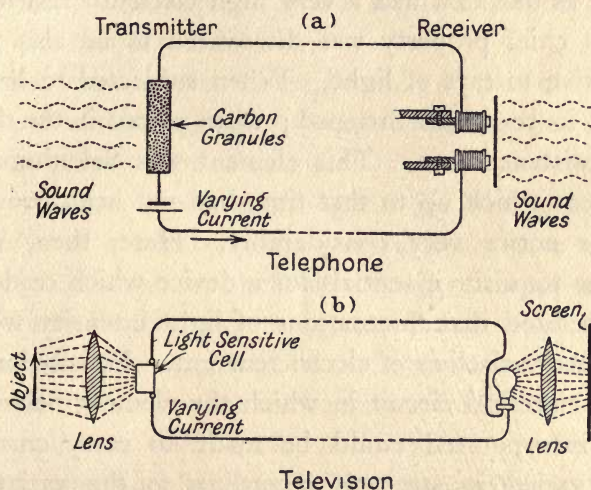


FIG. 8.—Similarity of Telephone and Television methods.

illustrate the principle on which the arrangement could be made, it will be seen how far their arguments were justified.

The chief difficulty that presented itself in their endeavours to accomplish this end successfully was the provision of an artificial eye that would transmit the image of the scene or object.

Finding an Artificial Eye.

A fortunate circumstance aided investigators while they were endeavouring to develop the idea of setting up an artificial eye. An element that had been known for a considerable time to chemists and electricians as one that had a very high electrical resistance as its chief property was discovered to be also very sensitive to rays of light. When subjected to bright light, its resistance dropped; when placed in the dark, its resistance rose. This element was Selenium, an element which up to that time had not been brought under notice very considerably. Here, then, were all the requisite essentials for a device which could be so operated that fluctuations of light intensity would produce variations of electric current. For obviously, if an electrical circuit in which the element Selenium was incorporated could be made to carry currents that varied in strength according to the variations in light and shade that go to form a picture, the problem would be solved. Other elements like potassium, rubidium, etc., have since been taken into the service of wireless seeing, especially in connection with photo-electricity and photo-electric cells. These light-sensitive constituents for the make-up of artificial eyes will be discussed in detail later.

Since the time when some sort of chemical eye was sought after, rapid strides have been made in the technique of television, so that to-day there are other aspects from which the solution of the problem

may be viewed, and although no published results of attempts have yet appeared, if any discoveries have been made it is possible that one day light rays may be transformed into electricity and back again into light by one piece of apparatus. We have but to consider phenomena revealed to us by modern instruments and appliances like high-vacua pumps to recognise this possibility.

Take, for example, the exploration of the very wide band of electromagnetic waves consisting of eight octaves between the ultra-violet rays and the *X*-rays. The rays in question are so extremely absorbable by matter that special vacuum spectrometers have to be brought into use for their detection; their existence would still be unknown to-day but for the application of the principle employed in the high vacuum pump. It is quite possible that in the future fresh discoveries and appliances will enable us to extend the field of investigation and bring additional knowledge to bear on the subject of wave-frequencies and the relation of light rays to electricity so that science will be able to transform the one into the other.

While on this subject, we may glance at the wave-lengths, or rather frequencies, of light waves as compared with the wave-lengths or frequencies of the wave-bands that are utilised in electric transmission, that is, the propagation of electric currents either in conductors or otherwise. Electric waves are exactly like light waves in that they can be reflected, refracted, polarised, absorbed, and diffracted; they differ,

TABLE OF WAVE-LENGTHS

X-RAY WAVES ←	LIGHT WAVES		UNKNOWN RADIATION	RADIO WAVES →
INVISIBLE	INVISIBLE	VISIBLE	INVISIBLE	INVISIBLE
OCTAVES →	ULTRA VIOLET			
	0.1 μ	0.4 μ	100 μ	
	0.2 μ	0.8 μ		

1 Micron written $1\mu =$ a thousandth part of a millimetre (mm.)

WAVE LENGTH
↓
10 mm.

1 mm.

100 μ

10 μ

0.8 μ

0.4 μ

0.2 μ

0.1 μ

however, from light waves, in that their length may be inches, feet, yards, or even miles, whereas light waves measure a few millionths of an inch only.

We have reason to believe from the electro-magnetic theory of light that the velocity of light is the same as that of electricity, and this velocity has been estimated at 186,400 miles per second or 30,000,000,000 cm. per second in air or vacuum. Hence, knowing frequency the wave-length can be deduced at once from

$$\text{wave-length} = \text{velocity}/\text{frequency}$$

$$\text{i.e.,} \quad \lambda = v/f$$

where λ is the wave-length, v the velocity, and f the frequency.

In the case of an oscillatory electric spark lasting, say, one five-millionth part of a second as seen by the eye, there may be twenty successive oscillations each lasting only one-hundred-millionth part of a second, the frequency therefore is one hundred-million a second; dividing 30,000,000,000, by 100,000,000 we get 300 cm. (or 10 feet approx.) as the wave-length.

Now there is a very wide range of wave-lengths or frequencies between the latter kind of waves and those of all kinds of light, visible and invisible. This may be seen at a glance by inspection of the values given in the accompanying table.

How can we transform or convert these very small light waves into electric waves and *vice versa*? At present we do not know. Two principal obstacles stand in the way of achieving this object, first,

the extremely absorbable nature of light rays, and, secondly, the impossibility at present of measuring them. There is also another drawback, namely, the difficulty of propagating light waves over a considerable distance, even when obstacles do not intervene, due to loss of energy during the process of propagation.

CHAPTER II

HISTORICAL

INVENTORS and others, inspired by brilliant and (to them) original ideas, often throw away a surprising amount of time and labour, because the historical side of their subject is not or cannot be studied. A little time spent in looking briefly at attempts made in the past would save many an inventor from the pitfalls which so often beset him.

One great advantage of studying or glancing briefly at the historical aspect of the problem at issue is that it gives the inventive mind a good perspective view before setting out. It shows the technical difficulties and sometimes the commercial aspects whereby one may guard against the deficiencies of preceding attempts and the more quickly surmount the difficulties that have confronted other inventors. Moreover, as one of the objects of a book should be to inspire or excite action, the following summary of what has been already essayed in the direction of television is given in the present chapter.

The Pioneers.

The name of the early inventors is legion, and we can only give a few of the more prominent workers whose endeavours to transmit pictures and images by

means of electrical apparatus reveal to us that experiments with a view to transmitting pictures and writing by electrical means took place so far back as 1847. The researches that have now been going on for more than a quarter of a century have gradually unfolded ideas that have culminated in the desire to view contemporaneously far-off events that are happening, just as past events are pictured on the screen at cinemas.

The first indications of a trend in the direction of discovering means for electrical seeing are evidence in

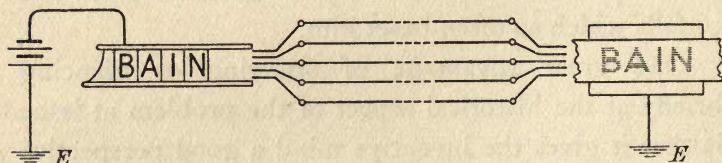


FIG. 9.—Bain's Chemical Recorder.

the embryo stage, when drawings, contours, and diagrams were transmitted over wires by electric current in 1862 by Abbe Caselli. This system was in practical operation for several years between Paris and Amiens. It was really a more elaborate form of Bain's chemical recorder (1842), and Bakewell's apparatus (1847), paper treated with cyanide of potassium being marked by an electric current through an iron point or stylus. Bain's apparatus is interesting in that he used a form of copying telegraph as shown in the illustration, Fig. 9. The letters to be transmitted were actual metal types set up in a composing

stick and connected to an earthed battery. Five metal brushes, made up of several narrow springs connected to the same number of lines were passed over chemically prepared tape resting on an earthed conducting plate. As and when the currents were received over the line, marks were made on the paper and a copy of the type faces at the transmitting end was obtained. It was necessary for the two brushes to move in synchronism.

Bakewell in 1847 followed in the wake of Bain

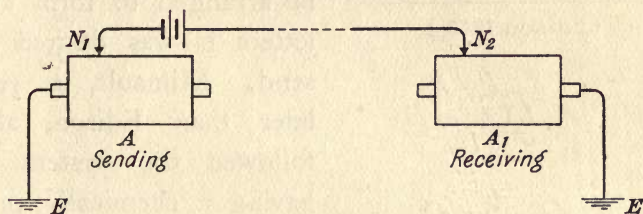


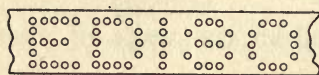
FIG. 10.—Bakewell's Apparatus.

with apparatus something similar in character. He set up at the two ends of a telegraph wire two metal cylinders (A and A_1 , Fig. 10) which revolved in synchronism, while metal needles, N_1 and N_2 , connected to a battery traced out spirally at one end a sketch drawn in shellac-ink, and at the other end a replica on chemically prepared paper was produced.

At the sending end the sketch was drawn on a sheet of tinfoil wrapped round the cylinder, and a sheet of chemically prepared paper was placed on the receiving cylinder. When the needle N_1 came in contact with a shellac line no current flowed, but when the

needle was in contact with tinfoil (and, of course, the cylinder) a current passed through the circuit, causing a chemical mark on the paper on A_1 .

Edison improved on these methods in 1873 by substituting a punched tape for the inconvenient composing stick with metal type (see Fig. 11) and previously in 1865 Messrs. Vavin and Fribourg produced a kind of monogram by their method as shown



(Edison 1873)

ab

a b c

(Vavin & Fribourg 1865)

FIG. 11.—Edison's and Vavin and Fribourg's Apparatus.

in the same sketch, the elements of which could be arranged to form any letters it was desired to send. Mimault, a year later than Edison, also followed the system of having a chemically prepared receiving tape. A printing lever brought the tape in contact with an insulated block containing

49 pins, a suitable selection of pins connected to a battery being capable of printing any desired letter.

The diagram in Fig. 12 shows the connections for sending the letter "T."

We thus see that from the crude endeavours of Bain and others to communicate electrically with distant points by means of metal letters, hearing and seeing from remote parts of the world as achieved to-day have been developed. The growth may be regarded in the light of a family tree, Bain's work



FIG. 13.—Showing how a Picture may be drawn by means of Lines of Varying Width.

[To face page 39.]

being the stem from which sprang branches, notably telegraphy with its long and short signals in code, and picture or photograph transmission with its "parallel lines" of varying width corresponding with the dark and light portions of the picture (see Fig. 13)

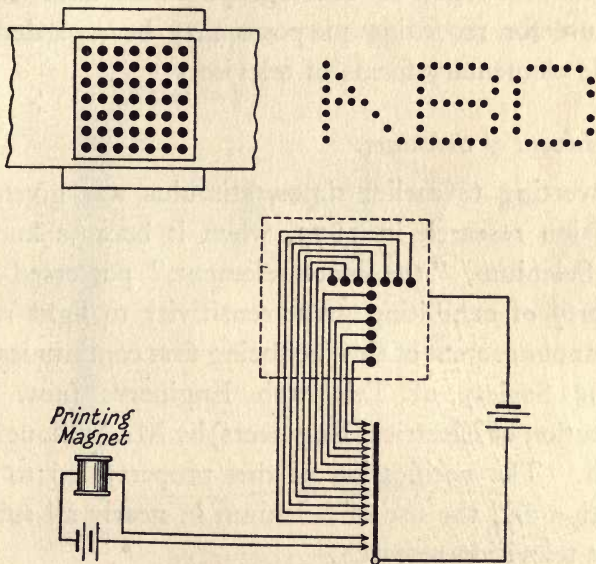


FIG. 12.—Mimault's Method and the Arrangement for Signalling the letter "T."

from which latter television eventually became an offshoot.

This idea of transmitting drawings and writing to distant points—the forerunner of television—continued to produce inventors as late as 1900–1901. The Telautograph, an instrument for reproducing actual handwriting at a distant station, and the Telepantagraph, an instrument for transmitting actual

drawings over considerable distances by means of telegraphy, were placed under experiment in the Electrical Research Laboratories of the G.P.O. during that period.

It should not be overlooked, moreover, that even the various types of oscillographs that have come into use for recording purposes may be regarded as simple elementary forms of televisors.

The Advent of Selenium.

Reverting to earlier times, stimulus was given to television research in 1873, when it became known that Selenium, "the moon element," possessed the property of exhibiting great sensitivity to light rays, the announcement of this fact being first communicated to the Society of Telegraph Engineers (now the Institution of Electrical Engineers) by Mr. Willoughby Smith. The notification of this property led to the adoption and the use of Selenium in nearly all subsequent television research.

Many attempts were made during the following decade to enlist this newly-discovered property of Selenium in the service of television, but it was not until M. Senlecq in 1877 brought out his "telectroscope," mainly modelled on Caselli's apparatus (Fig. 14), but with Selenium as an ancillary operating device, that any real theory of television was disclosed. In this apparatus the principle of reproducing by electromagnetic means the effects of light and shade that were cast on an object was adopted. This was

to be accomplished by projecting the image to be transmitted on to the ground glass of a camera obscura, tracing it out by means of a Selenium point; when transmission took place variations of current in the latter were to cause the effects of light and shade to appear at the receiving end. The invention was regarded as so important a step in advance of its

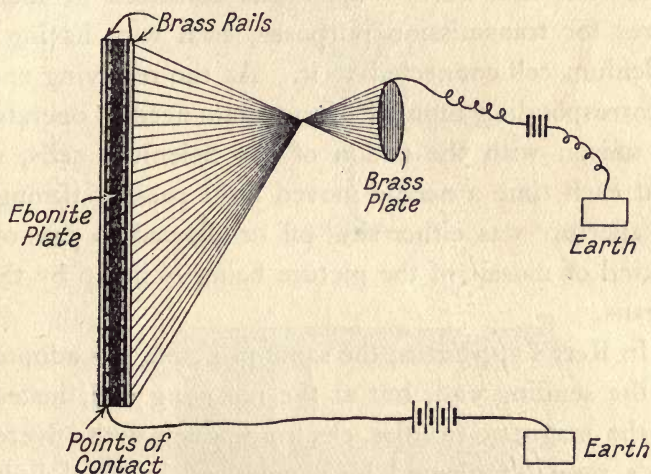


FIG. 14.—Senlecq's Apparatus.

predecessors that several other workers, amongst them Graham Bell, the inventor of the telephone receiver, brought out similar inventions and apparatus. It is perhaps noteworthy and remarkable that attempts were being made to transmit pictures electrically at the same time that attempts were being made to transmit sound electrically, both problems being the subject of investigation by the same genius, Graham Bell.

In 1880, Messrs. Ayrton and Perry and also Professor Kerr published an account of their proposed television system. Selenium cells were employed in this system, all of which were worked with a multiple wire (and multiple cell) arrangement, each wire contributing a small portion of the picture until the whole was pieced together in mosaic form.

Ayrton and Perry's apparatus consisted of many wires for transmission purposes, each wire having a Selenium cell connected to it. At the receiving end, a corresponding number of magnetic needles operated in unison with the action of the Selenium cells, so that each time a needle moved light passing through an aperture was either shut off or allowed to pass on, a kind of mosaic of the picture being built up by this means.

In Kerr's apparatus, the same principle was adopted at the sending end, but at the receiving end, instead of the magnetic needles, electro-magnets with silvered ends were illuminated by a polarised beam of light. The currents received through the electro-magnets rotated the plane of polarisation according to the amount of light sent out.

Employment of Thermo-Electricity.

It was in 1880 also that Middleton, of St. John's College, Cambridge, announced his invention of apparatus in which thermo-electric couples instead of Selenium cells were employed in a multiple wire transmitter. Corresponding thermo-electric couples

were fixed at the receiving end, which received the radiant heat sent out at the transmitting end in the form of reflection from the bright-polished surfaces of the thermo-couples.

In America in the same year, not only did Graham

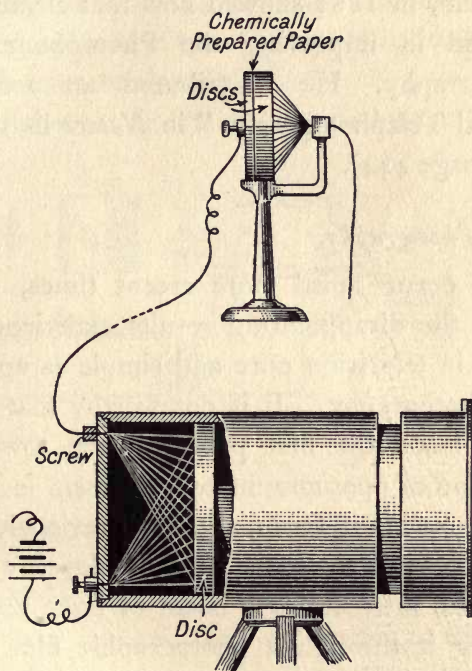


FIG. 15.—Carey's Apparatus.

Bell take out patents for television apparatus, but also Connelly and McTighe, of Pittsburg, and Dr. Hick, of Bethlehem, Penn.—the apparatus invented by Hick was called the "Diaphote." Carey, an American, in the previous year had also brought out apparatus of the multiple wire type (Fig. 15), with the

Selenium cell arrangement at the transmitting end and an incandescent receiver containing carbon or platinum elements (see *Sci. Am.*, Vol. 40, page 309, 1879).

Shelford Bidwell, an experimenter on the properties of Selenium, in 1881 showed how that element could be applied in improving the Photophone and in telephotography. He contributed an account of "Practical Telephotography" in *Nature* in 1907 (see Vol. 76, page 444).

Wireless Photography.

A gap occurs until more recent times, probably owing to the disappointing results experienced with Selenium in television pure and simple as apart from picture photography. It is noteworthy that in 1908 Knudsen made the first practical step towards the transmission of photographs by wireless.

De Bernouchi, of Turin, also had previously devised a system for this purpose. He employed a method whereby the intensity of a beam of light was varied by passing it through a photographic film on to a Selenium cell, the resistance of the latter varying at each instant accordingly (Fig. 16).

Cathode-ray Systems.

Impetus was given to the pursuit of the transmitting pictures by wire by Ruhmer (1891), Rignoux and Fournier in France (1906), Szczepanik in Austria, and Rosing in Russia (1907), who sought to achieve

perfected results. Rosing made use of the Cathode-ray in his apparatus and Mr. Campbell Swinton, in this country at about the same time, designed quite independently a Cathode-ray system of television. These are mentioned as marking important steps towards the solution of television. Improvements in phototelegraphy have been going on up to the present time with remarkable results.

In addition to the attempts made by the foregoing,

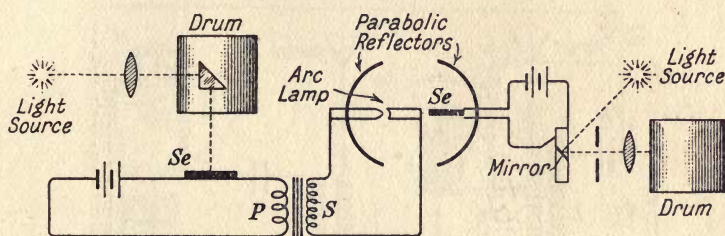


FIG. 16.—Bernouchi's Method.

the pioneer inventions of Korn (1907) and of Knudsen (1908) perhaps deserve special notice.

Korn's Experiments.

The first method of successfully transmitting photographs was that of Professor Korn in Germany, who made use of a circuit arrangement of which the essential features are given in diagrammatic form in Fig. 17.

The apparatus invented by Korn was afterwards set up with certain modifications and improvements by the Poulsen Company for the wireless transmission of pictures. In view of the distinct advantage

which characterises this invention from all preceding attempts, a description of its working is given below, although space forbids any details beyond the merest outline.

In the figure, D is a revolving cylinder or drum on which is wrapped a metal print, and when the stylus, Z , traverses this, the receiving apparatus records by means of a string galvanometer denoted by H , a copy of the picture. A high frequency alternator or

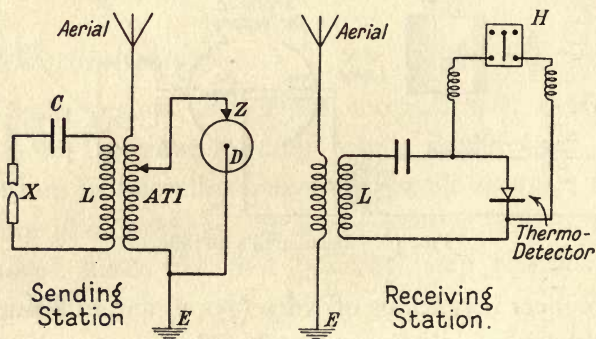


FIG. 17.—Diagram of Korn's Circuit.

Poulsen arc generator, X , generates continuous or undamped waves. Tuning is effected by means of the ATI , the inductance, L , and Condenser, C .

For transmission, Korn's apparatus consists of a glass cylinder or drum, which revolves in a box on a threaded shaft, thus giving it also a vertical motion as shown in Fig. 18.

A source of light, L_1 (for example, a Nernst lamp), has its rays cast by means of a lens system so that they intersect on the surface of the cylinder or drum,

C_1 , whence they are passed on to a prism of 45° , P_1 . In revolving, the cylinder on which is wrapped the photographic plate thus causes different small portions of the picture to come under the intercepting rays; the entire picture is therefore traversed by the light beam during the process. As often as the light variations occur, so are they reflected by the prism on to the Selenium cell, Se_1 , which in turn suffers

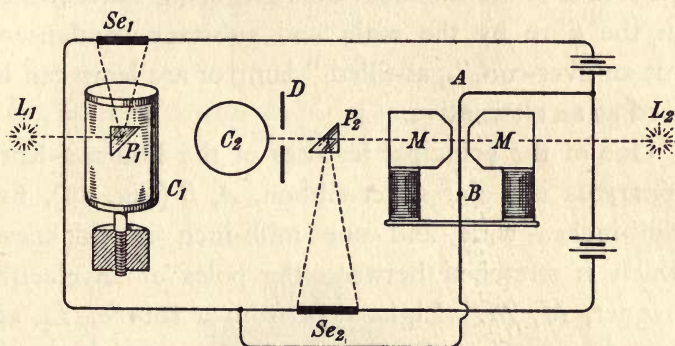


FIG. 18.—Arrangement of Korn's Apparatus.

variations in its resistance, thereby giving rise to the varying electric currents that are sent out to the receiving apparatus.

The Poulsen-Korn System.

In this apparatus as operated in the practice of phototelegraphy by the Poulsen Company, a string galvanometer of the Einthoven type (Fig. 19) was introduced as a means for directly reproducing the picture. The Einthoven galvanometer is the simplest form of oscillograph. Its essential part is a stretched

conducting fibre or wire placed in a strong magnetic field. This fibre is made very fine; if of silver or tungsten a diameter of 0.02 mm. or less is the general rule, or if of silvered glass a diameter from 0.002 to 0.003 mm. is quite common. The figure shows the general arrangement of mounting the fibre in the magnetic field.

It is usual to have a Pointolite lamp (Fig. 20) for the source of illumination, the light being concentrated on the fibre by the main and substage condensers, but an over-run "gas-filled" lamp or arc lamp can be used as an alternative.

One of the principal features of the Poulsen-Korn apparatus is a flat silver ribbon, A, B (Fig. 18), five milli-inches wide and one milli-inch in thickness, which is stretched between the poles of an electromagnet, M, M . Light rays from a source, L_2 , are brought to a focus by means of a lens, and it should be mentioned that the pole pieces of the electromagnet are tunnelled for the purpose of allowing the light rays to converge to a focus. Normally this silver ribbon cuts off all rays of light, but if the least current traverses A, B , the magnetic field that is acting causes it to be repelled. The degree to which the ribbon is shifted depends on the strength of current passing whether the movement be very small or otherwise, and the light is thus allowed to reach a second lens, by which it is focussed on to the surface of the receiving photographic film. Like the arrangement at the transmitting end, this film is wrapped round a revolving

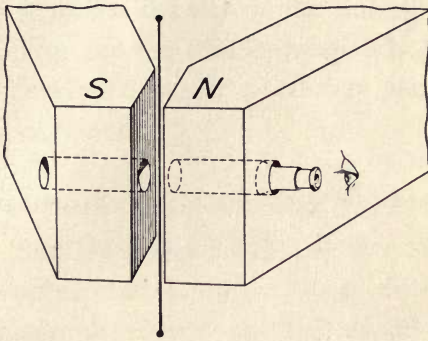


FIG. 19.—Diagrammatic Illustration of the Einthoven String Galvanometer.

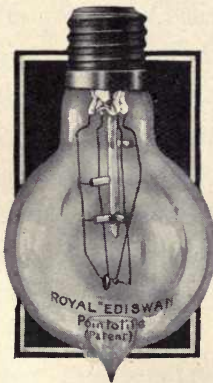


FIG. 20.—Pointolite Lamp.

[To face page 48.]

drum, C_2 , in a cabinet or camera from which all light is excluded. Since the intensity of light varies according to the density of the image, the amount of light falling on the film corresponds likewise. The film is developed in the usual way and a copy of the original obtained.

The Transmission of Pictures over Telephone Lines.

The Bell Telephone Laboratories Inc. of America have worked out a much more efficient system of phototelegraphy based on that of Korn's invention. As will be seen by the following description of working, it differs very little from Korn's except in so far as up-to-date improvements are added. For instance, whereas Korn used a Selenium cell, a photo-electric cell now takes its place. Other improvements have also been introduced, the chief of which is a much more accurate method of keeping the two cylinders in perfect synchronisation. This has been rendered possible by regulating the speed of the special type electric motors used and with the aid of phonic wheels controlled by tuning-forks operated electrically.

The Transmitter and Receiver.

Transmitting by this method depends first of all on having a negative of the photograph prepared from which a positive is made on a celluloid film 5 by 7 inches wrapped closely round a hollow glass cylinder. The latter is mounted on an arrangement so that it travels longitudinally at the same time that it is rotating

round its axis. A source of light throws a spot of light on to the cylinder with its film, and this spot travels over the film in a spiral direction on account of the motion already referred to. Inside the cylinder is a photo-electric cell. Obviously the spot of light while traversing the film gives out light in varying intensity according to the lightly- or darkly-shaded portions of the photograph and thus varies the amount of current received from the cell which is connected locally by wires to the main lines. This action is tantamount to modulating the current transmitted in accordance with the degree of light or dark shading of the picture.

In the apparatus at the receiving end there is a device termed a "light-valve" having a small orifice which is normally covered entirely by a very thin metallic ribbon, the latter being subjected to the influence of a magnetic field. At the same time, a very strong beam of light from an electric lamp is directed through the orifice mentioned. Now when the incoming current traverses the ribbon, an electromagnetic field is set up around the ribbon, and this, acting in conjunction with the magnetic field already generated, causes the ribbon to shift, thus allowing a certain modicum of light to pass through the aperture. Obviously the movement of this ribbon being governed by the varying incoming current will correspond with the amount of light and shade of the picture at the sending end. Hence a cylinder on which a blank film is wrapped, provided it revolves in exact syn-

chronism with the cylinder at the sending end and is placed so that the light beam strikes it, will have

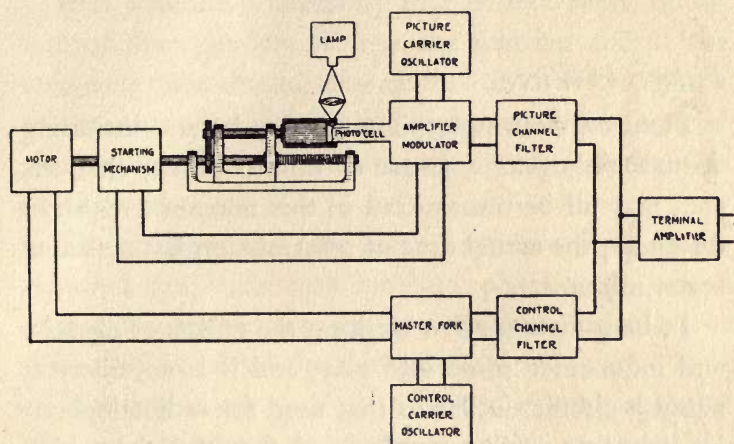


FIG. 21.—Schematic Diagram of Sending End of Apparatus.

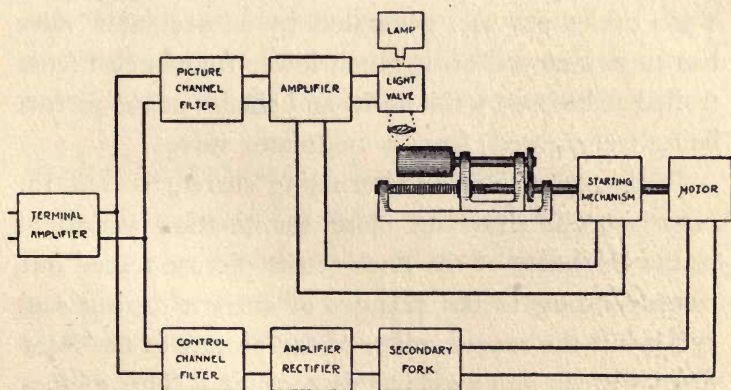


FIG. 22.—Schematic Diagram of Receiving End of Apparatus.

reproduced on it a negative picture or photograph which is an exact likeness of the original.

The essential parts of the electrical circuits used are shown in the schematic diagrams Figs 21 and 22,

which are taken from the *Bell System Technical Journal*.

Pictures by Wire.

Pictures, drawings, photographs, letters, including X-rays, radiograms, finger or thumb prints, cheques, etc., may all be transmitted in this manner over short distances, the actual time of transmission lasting about seven minutes.

In long-distance line working the effects of capacity and inductance come into play, and it is necessary to adopt a circuit similar to that used for radiotelephony by using an oscillator valve and a modulating valve. At the transmitting end, therefore, a frequency of 1300 cycles per sec. generated by an oscillator valve has superimposed on it much lower frequencies (controlled as before by the lights and shades of the picture being transmitted) from a modulator valve.

In this case, since an alternating current is sent, the negative will show on close examination variations in the thickness of the lines of the picture traced out, corresponding to the changes of current during each cycle, but the reproduction of the picture is not interfered with in any way on this account. This method gives about 65 lines to the inch and militates somewhat against the use of a ribbon for plates where reduction, enlarging, or retouching is necessary. Another method is to have an aperture of fixed measurements and to allow the light to fall on the film in a

diffused manner, when 100 lines to the inch may be selected and a half-tone picture produced.

It is absolutely necessary that perfect synchronisation of the cylinders both at the sending and at the receiving ends should take place. In order to ensure this, phonic wheels controlled by tuning-forks operated electrically are employed with the cylinder mechanism at each end.

The accuracy and efficiency of synchronisation now achieved are such that received photographs when sent over a line in this manner are indistinguishable to the naked eye from their originals.

The transmission of pictures and photographs by wire is carried out in America at the present time by the American Telephone and Telegraph Co. Amateurs in the United States of America who are in the possession of licences are allowed to use certain wave-lengths for the transmission of pictures.

Knudsen's Experiments in Radio Photography.

The first attempts made in wireless phototelegraphy over any considerable distance were those of Knudsen in 1908. As a matter of historical interest, a diagram of the apparatus used is given in Figs. 23 and 24.

The transmitter consisted of a camera with lens behind which was placed, between the lens and the plate, a line screen for splitting up the photograph into parallel lines. The photographic plate had to be specially prepared with a thick gelatine film. In this kind of plate the shaded portions of the picture

dry less quickly than the transparent or lightly-shaded parts. Hence, when iron filings or dust is sprinkled

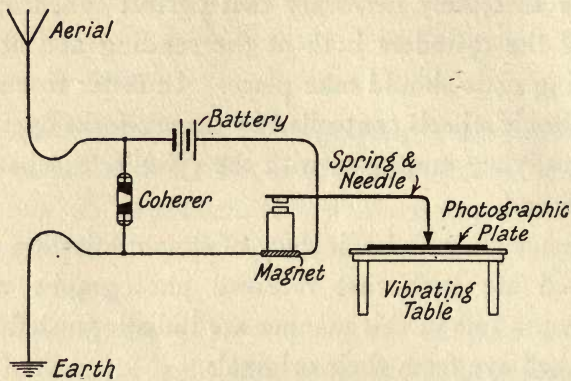


FIG. 23.—Knudsen's original Receiving Circuit for Radio Photography.

over it, the shaded portions retain more iron than the lighter portions. A steel point in conjunction with a

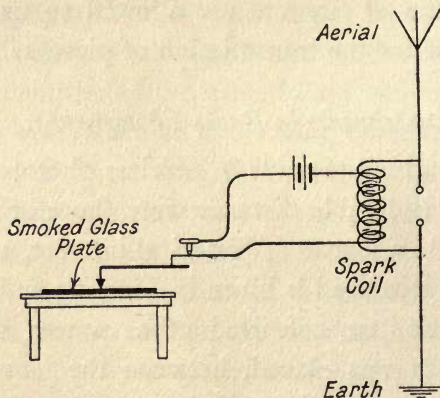


FIG. 24.—Knudsen's Transmitter Circuit.

spring is made to traverse this picture in iron dust, making contact and passing a current from a battery

where and when necessary, the currents being transmitted by wireless to the receiving end, where a similar steel point and spring actuated by a small electromagnet travel over a smoked glass plate. A print may be taken from the picture scratched out on the smoked plate in a manner similar to that adopted with an ordinary photographic negative.

The results obtained by this apparatus were extremely crude and it was found to be quite unsuitable for wireless transmission.

It is interesting to recall that Mr. Marcus J. Martin some years ago (1916) devised a system of radio photography by means of an instrument which he designated the "Telephograph."

A metal print of whatever had to be transmitted was necessary, and in preparing this print a screen having a number of ruled lines was used, the effect being to break the picture into parallel lines. The time for a complete transmission of a picture 5 by 7 inches with 50 lines to the inch took twenty-five minutes.

In working the apparatus the metal line print was wrapped round the drum of the machine, during the revolution of which a stylus made contact (or otherwise) with the lines of the print according to the light or dark lines into which the picture was split up.

By means of an optical arrangement at the receiving end variations of light from a Nernst lamp were received on the film on the drum at that end according to the point of contact of the stylus of the transmitter, *i.e.* whether tracing over a conducting or an insulating

strip on the metal print. By this means a positive picture was received from which a photograph could be reproduced. The obsolete syntonic system with Carborundum detector was used in the wireless portion of the apparatus. Further details of this interesting apparatus are given in Mr. Martin's book, "Wireless Transmission of Photographs."

Thorne Baker Apparatus for Wireless Phototelegraphy.

With this apparatus pictures can be broadcast by wireless which may be picked up by means of a simple form of apparatus adapted to a two-valve receiving set.

The transmission of a picture by this method is effected by first of all copying the photograph to be transmitted through a photo-mechanical screen. The latter is ruled with close parallel lines which cause the photograph to appear made up of thick and thin lines, the different shading in the image represented by dark and light parts of the photograph corresponding to thick and thin lines respectively. A photograph of this character is printed on sheet copper after the latter has been sensitised with fish-glue treated with bichromate of potash. The unexposed portions of this kind of plate can be got rid of by washing the plate in water, when the image will be clearly shown in fish-glue lines. It will be noted that these fish-glue lines are non-conductors of electricity. The picture is then wrapped round a revolving metal drum provided with a steel needle or stylus. As the drum revolves a current of electricity flows, and when-

ever the steel point touches a fish-glue line the current is broken, the wider the line the longer the break and *vice versa*, so that the degree of shading in the photograph will be represented by the width of the lines.

The transmitting circuit has the condenser in the valve circuit, which is short-circuited by a transmitter of this description and thus stops oscillation, radiations through the ether being controlled by the photo print on the drum. For receiving purposes, the apparatus at the distant end is provided with a revolving metal drum round which is wrapped the sheet of moistened paper chemically prepared on which the photograph is to be traced. This is done by a platinum stylus which traces a spiral path as the drum revolves.

It may be remarked that the stylus and cylinder are joined to the terminals to which either headphones or loudspeakers are ordinarily connected.

The actual printing is done by electrolytic action on the paper wrapped round the revolving drum. A dot, or rather series of dots, appears as very minute stains less than $1/200$ of an inch in diameter in some cases, dependent on the density or shading of the lines in the photograph.

Transatlantic Radio Pictures.

In November 1924 experiments took place at Radio House in connection with Marconi's Wireless Telegraph Co. by means of apparatus invented by Mr. R. H. Ranger and developed by the Radio Corporation of America, whereby photographs were

transmitted between Radio House, London, and New York. Briefly, the apparatus is constructed very much on the same lines as that of Korn's and others,

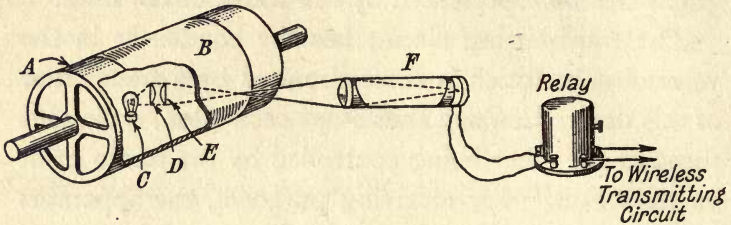


FIG. 25.—Diagrammatic Sketch of Ranger's Transmitting Cylinder.

the same principle of working and the employment of revolving cylinders, photo-electric cell, etc., being adopted. Fig. 25 shows the revolving glass cylinder, *A*, on which is wrapped the photographic film, *B*, the "Pointolite" lamp, *C*,

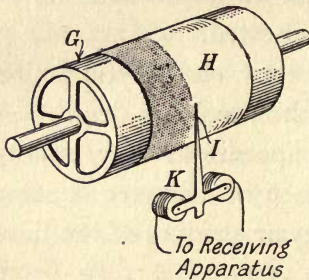


FIG. 26.—Diagrammatic Sketch of Ranger's Receiver.

inside the cylinder acting as a very powerful source of illumination. *D* and *E* are condensing and focussing lenses, respectively, the former for converging the rays to a point on the film whence it is directed to *E*, which focusses the beam on to *F*, the light-sensitive cell, placed some distance away from the cylinder.

The same principle of dark and light patches of the films controlling the variation in current is followed. The variations have their effect on the receiving apparatus, where in Fig. 26 *G* is the receiving cylinder,

1 NY WARWICK DEEPING LN

Guaranty Trust Company of New York
50, Pall Mall, S.W.1.

No. PE 18960

London

May 13th

1926

Pay to
the order of

Warwick Deeping

Two hundred sixteen pounds Seventeen Shillings and pence

£ 513 - 17 - 6

The Strangers Co

M. H. H. H.

W. H. H. H.



FIG. 27.—Specimen of Print sent by Radio.

郎

五

常

岡

研

米領布味
ルカノ
ル市

顧遠

愛疎

之之

來素

將平

謝

尚

謹賀新年

月元日

FIG. 28.—Specimen of Print sent by Radio.

[To face page 59.]

on which is revolving the paper, *H*, and *I* is a self-inking stylus or pen, worked by an electro-magnet, *K*, whose action is controlled by the received currents. The pen makes small dots or blanks in a series of lines according to the dark and light patches of the pictures. The spacing between the rows of dots is nearly $1/200$ th of an inch for each revolution of the cylinder. The image is therefore reproduced in the form of dots or lines and spaces. When telegraphing a picture or photograph by wireless, it should be borne in mind that in all the methods employed the current sent out by a photo-electric cell is superposed on the alternating current carrier wave sent through the ether at the same time.

Since the date mentioned, important improvements have been effected in this system, which at the time of writing is being operated successfully by the Marconi's Wireless Telegraph Company, Ltd., in co-operation with the Radio Corporation of America. A recent specimen drawing received by radio in London from New York was given in Fig. 2. Additional reproductions of original prints sent by radio across the Atlantic are given in Figs. 27 and 28.

Recent Research.

Mr. A. A. Campbell Swinton, F.R.S., in a lecture before the Rontgen Society and also at a meeting of the Radio Society of Great Britain some time ago, suggested the use of Cathode-rays, and showed that the difficulty of securing extremely rapid and accurate motion of parts could be got over by making use of

immaterial substances like these rays. He further described a new device for analysing the image under transmission and making use of a controlled Cathode beam which could be appropriately influenced by magnetic fields.

The apparatus for working out his idea on these lines, however, does not appear to have been constructed so far, and therefore any practical results that might be obtained by this means are not known.

During the last five years a crop of fresh inventors and aspirants has arisen. Most of these have brought forward new ideas, developments, and improvements, not to mention the scrapping of older devices, the Selenium cell, for example. Notwithstanding the sensitiveness of Selenium to light rays, it has been found that photo-electric cells respond in a far better manner to the enormous speed of signalling that is involved in all forms of transmission of vision. Hence in all recent developments the photo-electric cell is relied on for good results.

Television research has been carried out on the Continent by MM. Belin and Hollweck, Dauvillier, and numerous other workers, chiefly along the lines of the Cathode-ray.

Shadowgraphs have been successfully sent both by MM. Belin and Hollweck and by M. Dauvillier in France, and in Austria Denes von Mihaly claims to have achieved the transmission of shadows, using a complex apparatus of oscillating mirrors.

In America, C. F. Jenkins has successfully sent

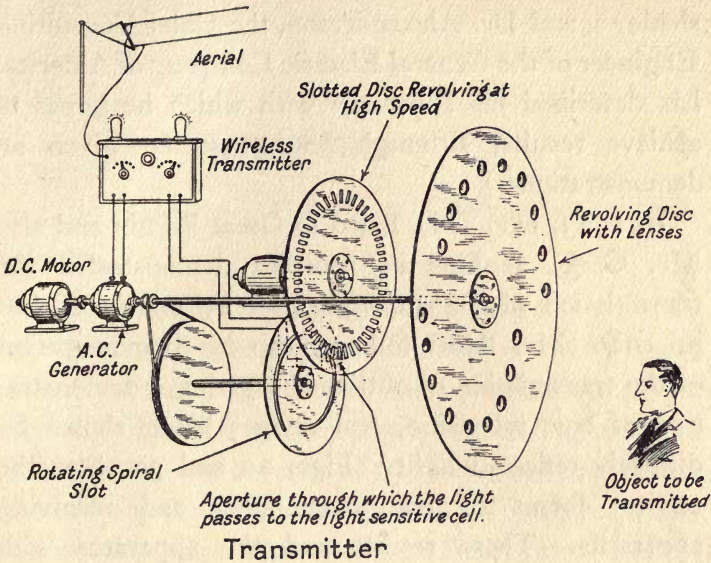


FIG. 29.—Mr. Baird's original Transmitting Apparatus.

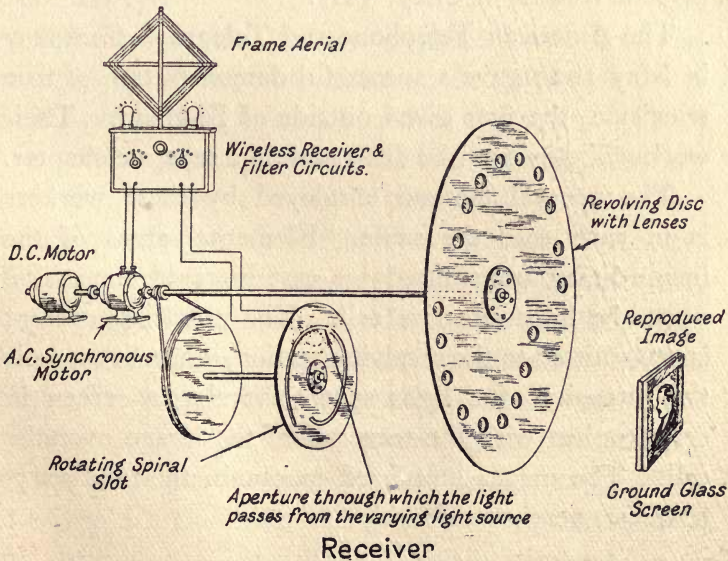


FIG. 30.—Mr. Baird's original Receiving Apparatus.

shadows, and Dr. Alexanderson, the Chief Consulting Engineer of the General Electric Company of America, has described his apparatus with which he hopes to achieve results, although he has so far given no demonstrations.

In 1923, Mr. J. L. Baird in Great Britain and also Mr. C. F. Jenkins in America demonstrated the transmission of "Shadowgraphs" by television, but in 1926 Mr. Baird followed up his demonstration of the transmission of outlines by giving a demonstration of true television, real images being shown by diffusely reflected light. Figs. 29 and 30 show the earliest forms of his transmitting and receiving apparatus. These results and the apparatus with which they were achieved are fully described in the present volume in Chap. VIII.

The American Telephone and Telegraph Company in May 1927 gave a successful demonstration of true television, the first given outside of England. Their work will, however, be dealt with in a separate chapter.

The general method employed by these workers is in each case the same. Elemental areas of the image being transmitted are cast in rapid succession upon the light-sensitive cell. The pulsating current is transmitted to the receiving station, where it controls the intensity of a light spot traversing a screen in synchronism with the traversal of the image over the cell. The means employed to obtain this end vary, however, very considerably.

CHAPTER III

SELENIUM AND THE SELENIUM CELL

Selenium.

THE history of the element Selenium is so closely associated with the history of television that a short account of the properties of this remarkable element may well form the preliminary to succeeding chapters of this book. No account of television, not to mention the early and ineffective systems of picture transmission that were tried, could be intelligently understood without an account of the properties of this electrical eye.

Selenium or the "moon element" was first discovered by the Swedish chemist, Berzelius, in 1817, in the red deposit formed in vitriol chambers. There are several allotropic modifications of this element, but for making a "cell" the grey or crystalline variety is selected, since this form conducts electricity. Its resistance to the passing of a current of electricity, however, under normal conditions is very high; when heated, its electrical resistance is increased. When exposed to rays of light, it instantly lowers its resistance from 15 to 30 per cent., according to the intensity of the illumination, but increases its resistance when the rays are shut off. The red rays appear to give the maximum effect. This property has been made

use of in certain determinations of feeble photometric intensities like those of the light received from the stars. On account of its property of sensitivity to light rays, it has therefore been employed considerably in television research work, being made up in the form of a "cell" for the purpose.

Although a member of a chemical family (Sulphur, Tellurium and Selenium) having all the same characteristics, Selenium, however, appears to be the only member of the family that is light-sensitive. It forms compounds with other elements in the same manner, for instance, that sulphur does; it assumes the same allotropic modifications and is capable of the same kind of transformation under the action of heat, etc., but apparently it is the predominant partner so far as light-sensitiveness is concerned.

Ordinary Selenium is red or dark brown in colour, according to the amorphous condition in which it occurs, but on being subjected to heat it turns bluish-grey in colour. It vaporises at about 655° C., and its vapour burns with a blue flame producing a characteristic penetrating odour which has been compared with that of decayed horse-radish (Thorpe).

A Chemical Eye Operated Electrically.

As we have already seen, the early inventors endeavoured to construct artificial telegraph eyes by substituting Selenium for visual purple and building an artificial retina out of a mosaic of Selenium cells, each of these cells being connected by wires to a

shutter. This shutter opened when light fell on the cell connected with it and allowed a spot of light to fall on a screen. In this way each cell controlled a spot of light, the image being reproduced as a mosaic formed of the spots.

While the baffling problem of "seeing from afar"—television—was in process of solution on the lines of nature's marvellous mechanism of the eye, another cognate problem, namely, "hearing from afar"—telephony—was actually solved by Hughes, Graham Bell, and others, by following the lines adopted by nature in the construction of the ear. The appearance of the Bell Telephone immediately stimulated workers in television research to devise mechanism that represented artificially the action of the eye. In this respect, as we have also seen, they were fortunate in having the extraordinary properties of Selenium brought to their notice, namely, its enormous resistance when an electric current is passed through it, and its remarkable sensitivity whereby its resistance is lowered when it is exposed to light rays.

This latter phenomenon first came under observation quite accidentally. The element was known to be a metal possessing enormous resistance, and this property made it useful in the construction of the high resistances used in telegraphy; such resistances were employed in the early days at Valentia, the terminal station of the Atlantic Cable, a little village in the West of Ireland. One afternoon the attendant, Mr. May, was surprised to see his instruments behaving in a

very erratic manner. It was a day of bright sunshine, and the sunlight fell occasionally upon his Selenium resistances. He found that every time the sunlight shone on the Selenium the needle of the galvanometer moved. The phenomenon was investigated and the light-sensitive properties of Selenium were disclosed.

Selenium thus provided a means of turning light into electricity, and the scientists of those days were quick to see that in Selenium they possessed a chemical eye which could be used for transmitting vision.

Make-up of the Selenium Cell.

All the apparatus invented in the early days depended for transmission of vision on the provision of some form of chemical cell that produced variations of electric current in the circuit in which it was joined when variations of illumination were thrown on to the cell. In the make-up of the cell Selenium was employed. The alkali metals, such as potassium, sodium, calcium, rubidium, have under certain conditions the property of sensitivity to light rays and of thereby producing an electric current, but these will be considered later.

As already mentioned in the previous chapter, the discovery that the resistance of Selenium altered considerably on exposure to light was communicated to the Society of Telegraph Engineers by Willoughby Smith. The announcement led to the construction of so-called Selenium "cells" by Shelford Bidwell, Graham Bell, Sabine, Minchin, and others.

Graham Bell was the first to make a practical application of this newly-found property of Selenium. He built up a Selenium cell by arranging two metal plates, one having fixed to it a number of studs, these studs being slightly smaller in diameter than a series of holes in the second plate. The two plates were fixed together so that the studs entered the holes but did not touch the second plate, the two plates being insulated from each other. Molten Selenium was then poured in to fill the interstices and annealed. Annealing is necessary because in its amorphous state Selenium is not sufficiently sensitive to light, the grey metallic variety only being conspicuously light-sensitive. When therefore the cell is ready to be annealed, it is placed in an oven and heated to a temperature of 180° C. for about five minutes, when the transformation from the amorphous to the greyish variety should be complete. It is then slowly allowed to cool.

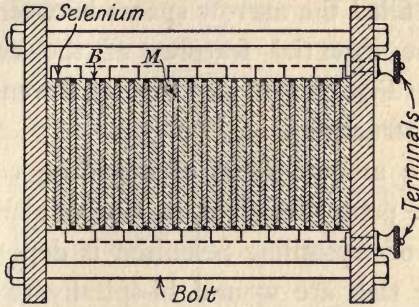
The process of annealing renders the cell more sensitive, but to obtain the best results it should be protected from moisture by placing it in a vacuum receptacle, or waxed to a plate of mica or glass. The early forms of cells were often painted over with a transparent varnish to protect them from the damp. Moisture decreases the resistance of the cell; it functions more efficiently when thoroughly dried.

Shelford Bidwell also constructed a form of Selenium cell. This form of cell may be made by taking a small sheet of ground-glass and spreading over it a very

thin layer of purified amorphous Selenium by means of a hot glass rod. If now four strands of bare wire, either nickel or platinum, are wound round the plate so that the whole of the surface is covered and two alternate strands are then removed, the other two strands are left separated for the whole of their length by a space equal to the diameter of a wire. The cell can then be annealed in the ordinary way.

Another method of making a Selenium cell is to spread a very thin layer of platinum on a glass plate and then to scratch a zigzag line across the platinum by means of a fine steel point. Selenium in the molten condition is then spread over the platinum layer and converted into the crystalline metallic form by means of heat, the zigzag line dividing the platinum layer into two separate parts or plates. Electrodes can be connected one to each part, the fine line of Selenium acting as a varying resistance when incident light is thrown intermittently on the cell. It may be remarked that the light on this form of cell should fall as nearly perpendicular to the surface as possible to increase its sensitivity. Any parts of the cell left unilluminated naturally increase the resistance and decrease the change in fluctuations of current through the cell.

In its simplest form a Selenium cell originally was made up of brass and mica plates on which Selenium was deposited. Thin, rectangular plates of brass and mica were clamped together alternately in a frame by bolts. Selenium was rubbed over the plates and the whole heated on a sand bath whereby the Selenium



Thin brass plates between which are placed thinner mica plates covered with Se

FIG. 31.—Early form of Selenium Cell built up of alternate sheets of Brass and Mica with surface layer of Selenium between the Brass Plates.

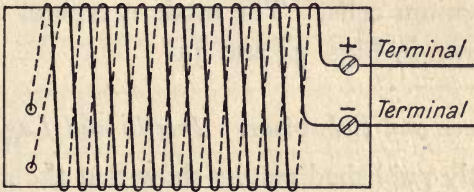
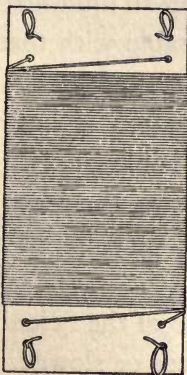


FIG. 32.—Early form of Selenium Cell.



Unmounted Cell

FIG. 33.—Modern form of Selenium Cell (unmounted).

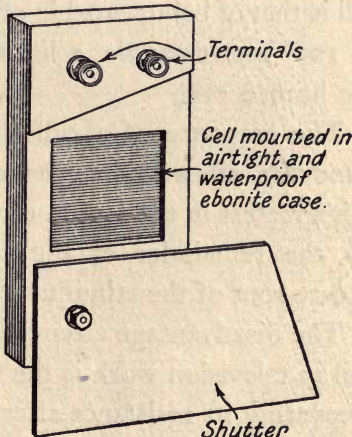


FIG. 34.—Modern form of Selenium Cell (mounted).

melted and filled the narrow spaces between the brass plates. The essential features of the construction are shown in Fig. 31 (see also Fig. 32 for another early form of construction).

The more modern form of Selenium cell consists of a steatite, porcelain, slate, or marble slab on which a thin coat of crystalline Selenium is deposited. On this steatite slab are wound bi-spirally two or more gold, platinum, or copper wires. The mineral steatite is favoured as a dielectric in modern practice, as, apart from its high insulation properties, it is practically non-hygroscopic, which is an important essential in all Selenium cells. The modern type of Selenium cell is shown in Figs. 33 and 34.

Performance and Behaviour. Inertia and Lag.

Recently published results show that the maximum sensitivity of the most efficient type of Selenium cell is that of being capable of detecting an illumination of 10^{-5} metre-candle, a limit comparable with that of the human eye.

The response of a cell to illumination is not the same for all wave-lengths of the visible spectrum; it is greatest in the region of the red rays, the response for the remainder of the spectrum varying as the square root of the stimulus-value.

The disadvantage attending the use of the Selenium cell in television work is the time factor or slowness in recovering its resistance after exposure to illumination, the period taken for recovery increasing with the intensity of the illumination to which it has been

exposed. Spontaneous change of sensitivity with lapse of time can largely be overcome by mounting the cell *in vacuo*.

In responding to rapid changes in the amount of

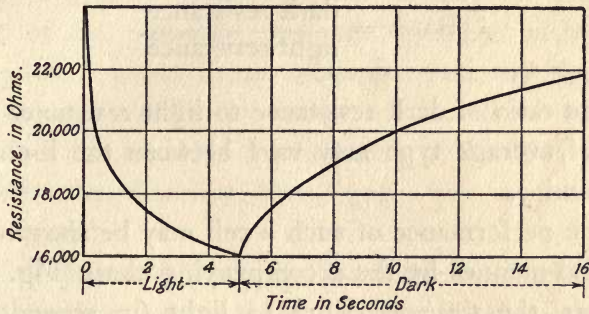


FIG. 35.—General Curve showing Inertia or Lag of a Selenium Cell.

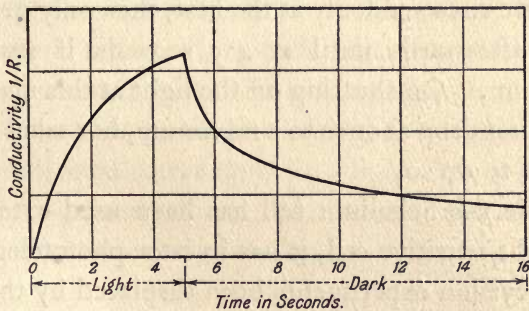


FIG. 36.—General Curve for behaviour of a Selenium Cell.

illumination falling on it, a Selenium cell exhibits a certain amount of inertia or lag, which is detrimental to the instantaneous effects demanded in television work. The higher the resistance of the cell the smaller the inertance. The effects are readily seen by reference to the two charts shown in Figs. 35 and 36.

The higher the resistance of a Selenium cell the greater the ratio of sensitiveness. The sensitiveness of a cell is the ratio of its resistance in the dark and its resistance when illuminated or

$$\text{Ratio} = \frac{\text{dark resistance}}{\text{light resistance}}.$$

The ratio of dark resistance to light resistance of a cell of average type may vary between the limits of 2-1 and 5.

The performance of such a cell may be shown in a general manner by the accompanying chart (Fig. 36). Taking the time exposure to light (in seconds) as abscissa and *RI* as ordinate, we see that the value of the curve rises suddenly at the first, then only gradually rising afterwards until at 4.5 seconds it reaches a maximum. On shutting off the light at this maximum it does not drop at once to a minimum, but takes several seconds to do so.

While the Selenium cell has been used extensively as a light-sensitive cell, it has in later phototelegraphic and television experiments been displaced by the more satisfactory photo-electric cell. The advantage possessed by the latter cell over the Selenium cell is that its action is certain and instantaneous, there being no evidence of lag or fatigue at any time during its period of action.

While Selenium has been discarded by modern inventors on account of the tardy manner in which it recovers its normal resistance value, Dr. Fournier

d'Albe holds that the lag in its action is purely a relative term. He contends that there is really no lag in its action, although there is a time interval between the stimulus given to Selenium and the final effect obtained. The process is a chemical one exactly the same as that of an instantaneous photographic plate, the stimulus is given to the Selenium and the chemical action commences at once, and he illustrates the truth of his assertion by referring to his Optophone experiments whereby 600 signals per second were transmitted.

This rate of signalling, however, is not sufficient for television, hence a disadvantage arises in the use of a Selenium cell for the instantaneous responses required; no light-sensitive cell is suitable for television work unless it responds instantaneously to the rapid variation of light and shade; the very fact that a curve can be obtained showing the lagging effect when subjected alternately to "light" and "dark" proves its unsuitability. An ideal sensitive cell should show no curve of lag.

CHAPTER IV

PHOTO-ELECTRICITY AND THE PHOTO-ELECTRIC CELL

General Description.

ALTHOUGH Selenium and Selenium cells have been and still are very much to the fore in experimental television research, they have to a certain extent been superseded by the photo-electric cell. This cell is capable of detecting the light of a candle two miles distant and of stars that would have otherwise been undiscovered but for its action. The flashing of light on its surface, moreover, need only last a millionth of a second. Photo-electric cells of cadmium and the alkali metals—sodium, potassium, rubidium, and calcium—are now used for the photometry of visible and ultra-violet light. Credit for the discovery of the photo-electric cell is really due, in the first place, to Hertz, who in 1888, when carrying out his famous Hertzian waves researches, found that the sparks set up by his apparatus passed more readily when rays of ultra-violet light lay in their path. This phenomenon led, through the work of Hallwachs, Elster, Geitel, and others, to the construction of glass tubes or bulbs from which air was evacuated, for the purpose of primarily demonstrating the action of light in producing electricity. Subsequent developments



FIG. 38.—The Langmuir Mercury Vapour Pump.

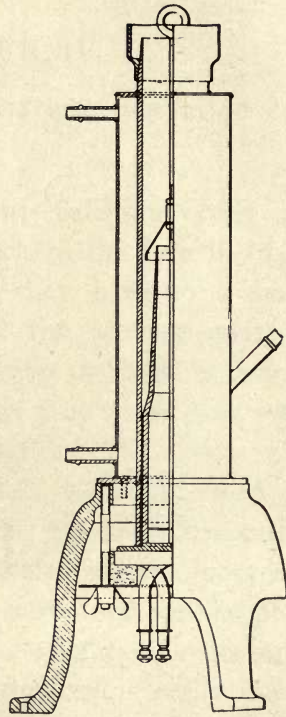


FIG. 39.—Diagram showing Internal Construction of the Langmuir Pump.

[To face page 75.]

in the design of such glass tubes and treatment with alkali metals brought about the evolution of the photo-electric cell. A cell of this kind depends for its action on the emission of a stream of electrons at the surface of the metal with which it is coated, usually an alkali metal such as rubidium, sodium, or potassium.

A suitably designed glass tube of the form shown in Fig. 37 is exhausted of all air by means of a special air pump. It may be remarked here that the pump

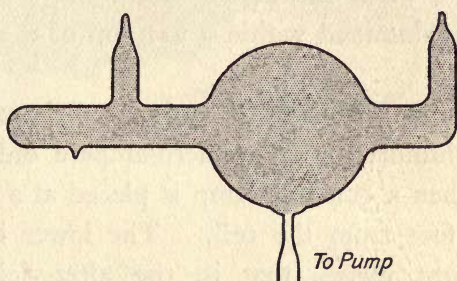


FIG. 37.—Glass Bulb of typical Photo-electric Cell.

that has displaced all others for high vacuum work is the Mercury Vapour Pump first devised by Gaede in 1915, the ordinary mechanical pump being useless for obtaining a high degree of exhaustion. Many improved forms of mercury vapour pump have since been developed; the present-day method of attaining high vacua is by means of the type known as the Langmuir Mercury Vapour Pump, an illustration of which is given in Figs. 38 and 39.

Certain portions of the tube are silvered and thinly layered with a deposit of the alkaline earth used

(rubidium, for example). The alkali metal is made much more effective if heated in hydrogen gas at a temperature of 350° C. The hydrides so formed are clear, colourless crystals, and on being bombarded by Cathode-rays become brightly coloured.

It is necessary for the photo-electric cell itself to be kept in a wooden box, light-tight except at one aperture for the admission of light rays that fall on the metallic coating. Freedom from parasitic effects is obtainable when the metal within the cell is prepared and maintained within a vacuum of the highest order.

The current given off by such a cell is extremely small, one-hundredth of a micro-ampere only being obtained when a 100 c.p. lamp is placed at a distance of half a foot from the cell. The lower band of invisible light waves, that is, the ultra-violet rays, produce greater sensitivity in the cell than the ordinary visible rays.

The Electrodes, Anode and Cathode.

Illustrations of a photo-electric cell (The Cambridge Instrument Co.'s type) are given in Figs. 40 and 41.

A fairly high voltage, about 250 volts, is necessary to work the cell of which the points of connection or terminals are marked *A* and *C*. The point of entry of current at *A* is called the *Anode*, and *C*, where the current leaves, is called the *Cathode*.

The axial electric field is not one of uniform value throughout the length of the tube. At the anode *A*

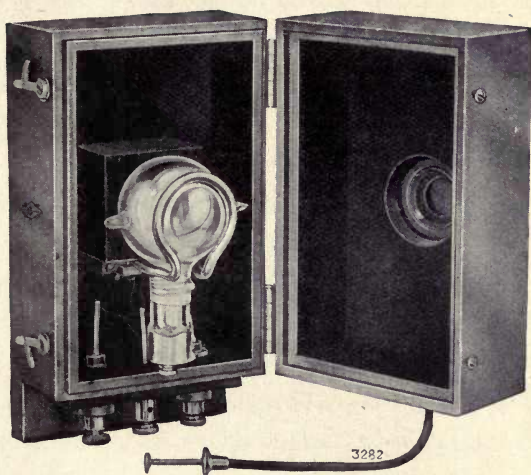


FIG. 40.—The Cambridge Inst. Co.'s Photo-electric Cell.

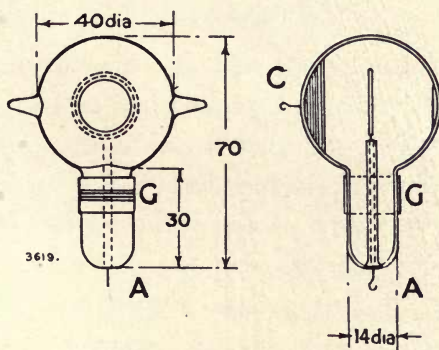


FIG. 41.—The Cambridge Inst. Co.'s Photo-electric Cell.
(Internal Construction.)

[To face page 76.]

there is a sharp fall of potential dependent on the current passing and the nature of the residual gas. The electric field fluctuates in value in passing from anode to cathode.

It is at the cathode *C* that the electrons originate by positive ray bombardments. The electric field is of high value very near the cathode, but it drops suddenly at the cathode itself.

Other features and phenomena connected with a vacuum or discharge tube are discussed in the next chapter, where the discharge tube is considered from the standpoint of a cathode-ray tube rather than a photo-electric cell, since interesting researches in television have been made with cathode-rays from time to time.

The Two Classes of Photo-electric Cell.

The photo-electric cell, like the wireless valve and the electric lamps employing tungsten filaments, is the outcome of high vacua research. There are two classes of this type of cell, namely, (*a*) the Vacuum type and (*b*) the gas-filled type. These we shall now proceed to describe. In the first-named class, the vacuum cell, the current passing through the cell is that which is liberated by the direct action of the light on the sensitive cathode. In the second class—the gas-filled cell—this current is magnified by the passage of the primary electrons through the gas with which the cell is filled and in which they produce secondary electrons. At the same time, the presence

of the gas makes it possible and useful to "sensitise" the cathode still further during preparation, by making it the cathode in a discharge in hydrogen, so that the primary current is greater than it is from an un-sensitised cathode. Gas-filled cells are therefore much more sensitive than vacuum cells; the same light may give several hundred times as much current. They are therefore greatly preferable to vacuum cells for all purposes in which sensitivity is of prime importance. Vacuum cells are preferable only when the incident light is to be measured accurately, so that the same light must always give exactly the same current and the current must be nearly proportional to the light.

Potassium in Vacuum Cell of the General Electric Company, Ltd. (of London).

As an example of a vacuum photo-electric cell take that manufactured by the General Electric Company, Ltd., the internal construction of which is shown in Figs. 42 and 43. The shaded portions are silvered, and on them is deposited by condensation from vapour a thin layer of either rubidium, potassium, or sodium. This surface has not been "sensitised" by the Elster-Geitel method of a discharge in hydrogen, the cells are completely evacuated and are not filled with gas. This method of preparation, though it sacrifices sensitivity, gives perfect reliability.

The cell must be enclosed in a light-tight box with a single opening against which is pressed the window

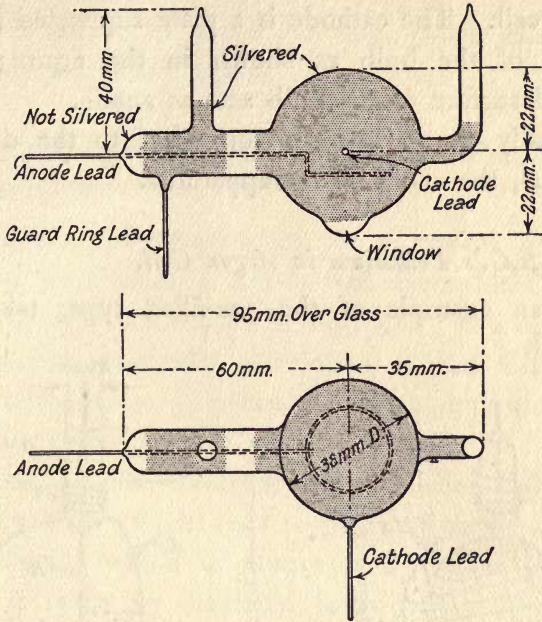


FIG. 42.—Internal construction of the General Electric Co.'s Vacuum-type Photo-electric Cell.

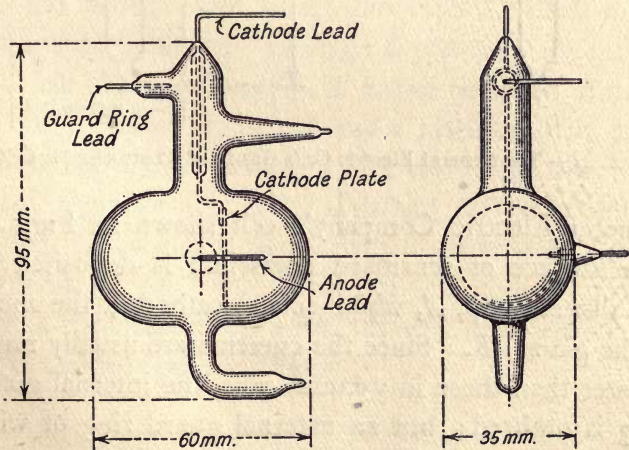


FIG. 43.—The General Electric Co.'s new type of Photo-electric Cell.

of the cell. The cathode is a plate supported in the middle of the bulb as shown in the figure; the silvered surface of the bulb acts as anode.

Usually the cathode is connected to the driving potential, the anode to the apparatus.

The G.E.C.'s Potassium in Argon Cell.

As an example of the gas-filled type, take the

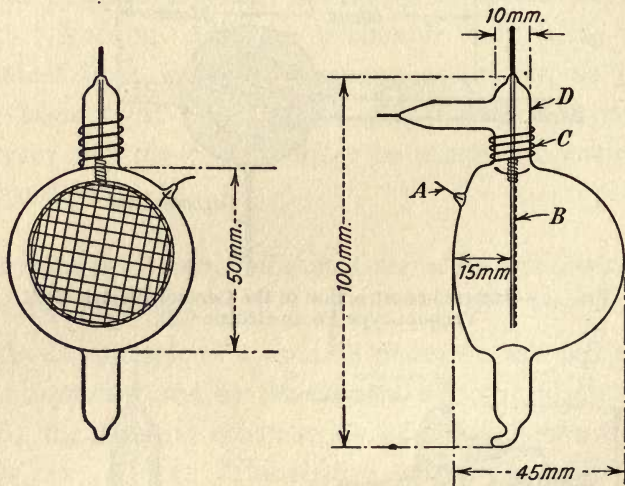


FIG. 44.—The General Electric Co.'s Gas-filled Photo-electric Cell.

General Electric Company's cell shown in Fig. 44. The surface of sensitised potassium is deposited on the silvered cup, *A*, which acts as cathode; the anode is the gauze, *B*. Since the currents are usually much greater than those in vacuum cells, the internal guard ring is omitted; but an external guard ring of wire, *C*, wrapped round the tube, *D*, and connected to

earth is sometimes desirable. The cell is filled with argon to a pressure of about 0.15 mm.

The Cambridge Instrument Company's Potassium in Helium Cell.

The internal construction of a typical gas-filled type of photo-electric cell is well exemplified in the photo-electric cell shown in Fig. 41. The cell is of the pattern originally developed at the Clarendon Laboratory, Oxford, potassium being deposited in a sensitive colloidal form on the silvered walls of the glass bulb. The electrons emitted when light falls on the cell are caught on a ring-shaped anode, *A*, and the current, which is proportional to the incident light, is taken by insulated leads to the apparatus. The current can be amplified by using an accelerating potential which causes ionisation by collision in the rare gas helium with which the bulb is filled at an appropriate pressure. Leakage is prevented by guard rings consisting of a strip of tinfoil wrapped around the outer surface of the cell and a platinum wire ring around the inner surface. The two rings are connected together and are maintained at the potential applied. The cell is fitted with a window (20 mm. in diameter, 20 mm. radius of curvature), which reduces to a minimum errors due to non-parallelism of the incident beam of light.

Sensitivity of the Photo-electric Cell.

A 60-watt gas-filled lamp with its filament 15 cm. from the vacuum type cell will give a current of the order of 10^{-8} ampere. The absolute sensitivity (*i.e.* the ratio of photo-electric current to luminous flux entering the window) varies by a factor not greater than 2 from cell to cell with the same active metal. To this light the rubidium cells are, on the average, rather less sensitive, the sodium cells rather more sensitive, than the potassium cells.

The sensitivity increases with the frequency of the light. Thus, for lamps of the same candle-power, the response to a vacuum lamp is somewhat less than that to a gas-filled lamp. The ratio of illumination to photo-electric current varies to a factor of less than 2 between a vacuum and gas-filled lamp, it varies less in this range for the rubidium cell than for the sodium cell, the potassium cell being intermediate. The variation of sensitivity with frequency of the light is very closely the same for all cells filled with the same metal. The sensitivity is independent of the temperature within atmospheric limits.

Variation of Current with Voltage.

Fig. 45 shows the variation of the current through a G.E.C. vacuum type cell with a given voltage between the electrodes. It will be seen that the current is not saturated, even with several hundred volts. The absence of saturation is not due to residual

gas and ionisation by collision, but to the form of the active surface which consists of fine drops from the

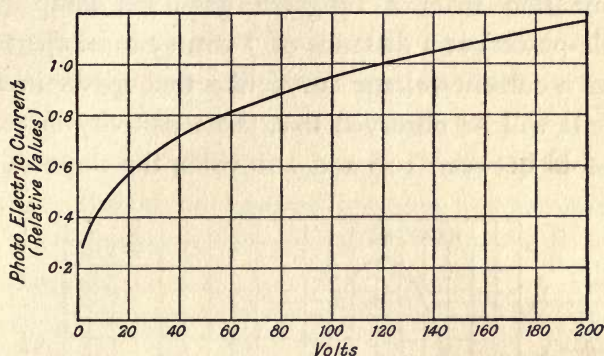


FIG. 45.—Curve of Current-voltage Variation (General Electric Co.'s Vacuum Cell).

interstices between which the electrons have to be dragged. The form of this curve varies somewhat

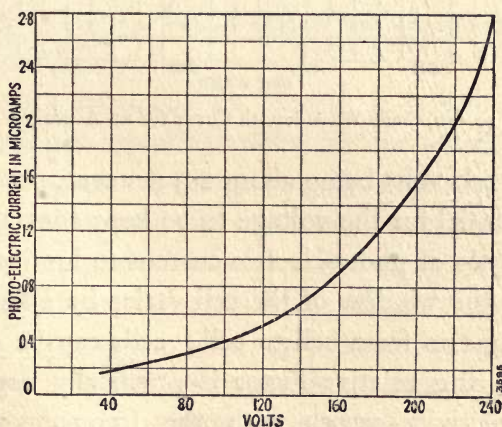


FIG. 46.—Current-voltage Curve of Cambridge Instrument Co.'s Cell.

from cell to cell, but never differs greatly from that shown.

The Cambridge Instrument Company's Photoelectric cell described on p. 81 when exposed to illumination from a tungsten gas-filled lamp (100 candle-power) at a distance of 7 cm. (5 mm. aperture) shows a current-voltage curve like that given in Fig. 46. It will be observed that the sensitivity increases four-fold between 100 and 200 volts, the slope of the

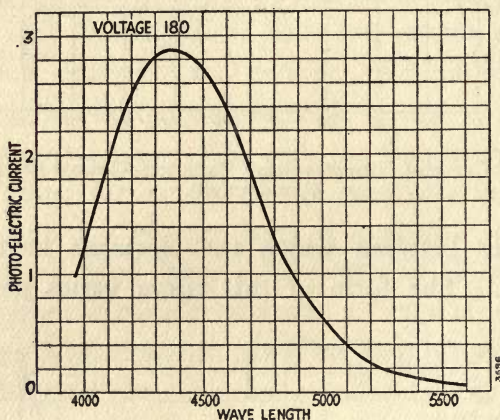


FIG. 47.—Current Wave-length Curve for an Average Cell.

curve at 200 volts being about 2.3 per cent. per 2 volts. It is essential for the voltage to be kept constant.

The ratio of photo-electric current to luminous flux entering the window of the cell varies by a factor not exceeding two from cell to cell; cells can be selected in which this relative factor is practically negligible. The sensitivity varies with the frequency of the incident light, and reaches a maximum value (due to the "selective effect") when the incident light has a certain fixed wave-length. The maximum value varies slightly from cell to cell, but remains constant for a

particular cell. Fig. 47 shows a current wave-length curve for an average cell; the ordinates are arbitrary units, corrected for spectroscope deviation and reduced to uniform intensity across the spectrum. Temperature changes within the normal working range (0° to 50° C.) do not appreciably affect the sensitivity.

A resistance of about 50,000 ohms, as shown in Fig. 48, should be inserted between the cathode, C,

and the high tension supply, in order to safeguard the cell should a spontaneous luminous discharge occur owing to an unusually large potential being

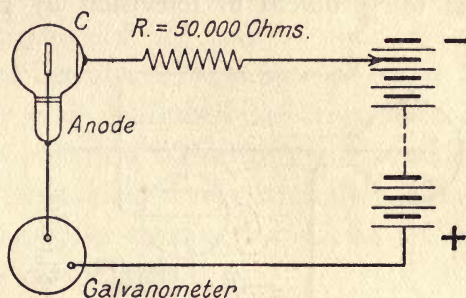


FIG. 48.—Connections for measuring Photo-electric Current.

accidentally applied. In general, it is safe to use a potential up to about 250 volts, but the actual potential at which glow discharge occurs depends to some extent on the particular cell. An indication that the potential for glow discharge is being approached can be gained from the sensitivity voltage curve, which can be constructed from the figures supplied with each cell. When the sensitivity doubles with an increase of, say, 10 volts, it indicates that the critical value is being approached, and it is not advisable to raise the potential much further. The potential can be conveniently applied by means of ordinary wireless high tension batteries.

Amplifying the Photo-electric Current.

Since photo-electric currents are so minute, it is necessary to employ a three-electrode (triode) valve amplifier in all practical applications, as the currents obtained are of the order of one-hundred-millionth of an ampere.

The three-electrode valve altered the whole aspect of the problem of television by giving a means of

amplifying the most minute currents to almost any extent, and an attempt was made to use the valve in conjunction with the photo-electric cell for that purpose, but although the three-electrode valve provides

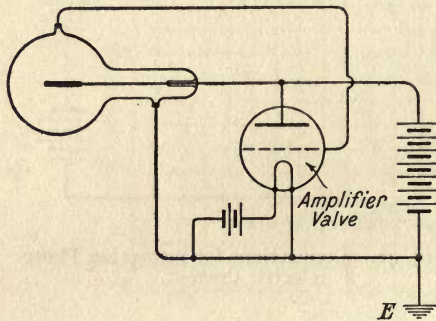


FIG. 49.—Method of connecting Amplifier to a Photo-electric Cell.

an immensely powerful amplifier, the amplification obtainable is limited. A stage is reached when irregularities in the emission from the first valve become audible, and if the signal is not heard before this point is reached further amplification is useless. Enormous amplification is obtainable before this stage is reached, but the response from the cell is very far below the limit. With the ordinary potassium cell, a further amplification of approximately a thousand times would be required.

A method for connecting the cell to an amplifier is shown in the diagram of Fig. 49. The current in the anode of the valve is automatically adjusted when no light falls on the cell, so that the effect is *nil*. An amplification of high degree can, however, be obtained when light rays fall on the cell. The current flowing in the anode circuit when the photo-electric current is zero can easily be compensated by obvious arrangements not shown, so that the indicator reads from zero. An amplification of 10^5 may be obtained by this method quite readily. The objection to it is that the amplifier is an extremely sensitive detector of high frequency electrical disturbances from which the apparatus has to be shielded very carefully. There are several other amplifier circuits that can be set up, but they are more complicated.

It is found that the amplification falls off considerably as the illumination increases (*i.e.* the amplification is greatest for small initial currents) and this result is to be expected from the general characteristics of the valve. Although the photo-electric current is proportional to the illumination, the amplified current is by no means linear, and the form of curve varies from valve to valve and with variations of anode potential, insulation, and filament current on the same valve. Amplifications varying from, say, 1000 to 10,000 can readily be obtained, but the higher amplifications are possible only with light intensities of small value.

In addition to the standard potassium cells, which have a sensitivity curve approximating to that of an

ordinary photographic plate, cæsium cells, sensitive in the infra-red region, or lithium and sodium cells, sensitive in the ultra-violet region of the spectrum and quartz cells are also made.

Disadvantages of the Photo-electric Cell.

Although photo-electric, a cell is rapid and instantaneous in its action, it does not always respond satisfactorily to the very small and limited amount of light available where television is concerned.

Shadows may be sent by its aid, for with shadows the light from any powerful source can be directed straight on to the photo-electric cell, but in television, where the objects or scenes concerned reflect only a very small and limited amount of light, the results are poor.

At very large amplifications the intrusion of parasitic noises due to battery irregularities and other causes sets a practical limit to the amplification obtainable. By great care, this limit can be extended, but even then a further limit arises in which the noise due to irregular emission of the valve filament makes its appearance.

Zworykin's Cell.

This is a three-electrode (or four-electrode) type of photo-electric cell in which the stream of electrons emitted is treated in the same manner as that of a thermionic tube and in consequence of its special construction increased amplification of the current is thereby obtained. By combining a three-electrode

valve in the same vacuum bulb capacity effects are somewhat reduced. It is claimed that the cell is an improvement over the ordinary combination of photo-electric cell plus three-electrode valve amplifier.

The construction of the cell is illustrated diagrammatically in Fig. 50, where the plate, grid, and fila-

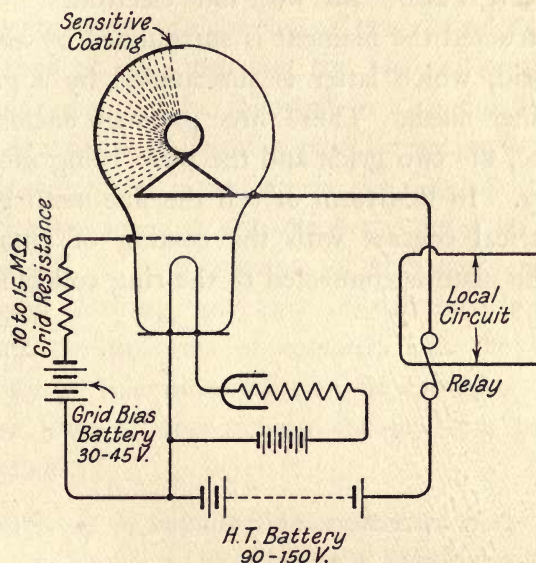


FIG. 50.—Zworykin's Cell.

ment of the valve portion of the cell are shown by the usual symbols. The valve is of the dull emitter type and not gas-filled. The upper section of the glass tube takes the form of a spherical bulb and on the inner side of this bulb a sensitive coating of potassium hydroxide is spread. This coating constitutes the anode of the photo-electric cell and as shown in the drawing is connected to the grid of the amplifier valve

below. An electron collector in the form of a wire ring, is connected to the plate of the valve. Both coating and collector are carefully shielded from the valve portion of the cell so that light from the filament may not fall on the coating. The method of connections is given in the figure.

The cell is also made with four electrodes. When so constructed the filament is surrounded by an open mesh grid, which latter is surrounded by a grid of much finer mesh. These three parts are enclosed by the plate, the two grids and the plate being mounted coaxially. In this form of cell the fine-mesh grid is in electrical contact with the coating of potassium while the plate is connected to the ring collector.

CHAPTER V

CONTINENTAL AND AMERICAN RESEARCHES

IMMEDIATELY subsequent to the discovery of the properties of Selenium and the recognition that the human eye might be followed as a model on which to design some practical means for seeing over long distances, several inventors on the Continent and in America constructed apparatus on the lines already indicated. A brief account of the early and later attempts, showing how they contributed their quota towards the progress of research and the ultimate evolution of television will now be given.

Two lines of approaching the problem presented themselves :

Either (1) *by imitating the construction of the eye very closely and having a large number of Selenium cells thereby forming a mosaic of the scene.*

Or (2) *by having one cell only and causing the illuminated elemental areas of the scene to fall in rapid succession on this one cell.*

Ernest Ruhmer's Attempts.

Ernest Ruhmer, whose brilliant pioneer work in connection with wireless telephony is so well known, constructed and attempted to realise television by

employing the first-named principle. Stencils of letters or simple objects were placed in front of a wall composed of a number of separate Selenium cells and forming a kind of screen, the idea being to build up the picture in mosaic form. Each cell was exposed to a certain amount of light according to the dimness or brightness of the light that happened to fall on it. Electric currents were sent out by these cells to a distant receiving screen of corresponding pattern and form and these received currents controlled the intensity of a light that illuminated the receiving screen, on which a luminous image appeared as a facsimile of the original. Although Ruhmer continued his investigations from 1901 till 1912, all his attempts at true television failed, chiefly through the inertia of the Selenium cells used and the prohibitive cost of such apparatus due to the number of cells required. He did, however, succeed in the transmission of crude shadows of simple objects such as letters of the alphabet, using 25 Selenium cells to form a crude mosaic of 25 spots of light.

Rignoux and Fournier.

These two French scientists constructed a similar machine to that of Ruhmer; it was intended only to demonstrate a principle, and had no pretensions towards presenting an instrument for television. The transmitter consisted of a wall covered with Selenium cells, 64 fairly large cells being used. From each of these cells two wires ran to the receiving screen, which was constructed with 64 shutters, each shutter

controlled from its respective cell, and thus when a strong current from a brilliantly lighted cell at the transmitter arrived at the receiving station its corresponding shutter was opened and light fell on to the corresponding part of the receiving screen. By covering the transmitting wall with large stencils, shadowgraphs of letters of the alphabet and geometrical figures were transmitted and could be recognised. The enormous number of cells, wires, and shutters required made the practical and commercial development of such a scheme quite unthinkable.

The Problem from a New Angle.

Many other workers were attracted by this system of building up a mosaic, but the thousands of cells, shutters, and wires necessary prevented the adoption of any schemes under (1) and an endeavour was made to solve the problem on the principle mentioned under (2). Instead of using a separate cell for each point of the picture, it was proposed to use only one cell, every point of the picture to fall in succession on this single cell, and the varying current from the cell to be transmitted to the receiving station, there to control a point of light traversing a screen exactly in step with the traversal of the image across the cell. The point of light was to be bright at the high lights, dim at the half-tones, and completely out at the black parts of the image, the process to be carried out with such rapidity that, owing to persistence of vision, the eye would see, not a succession of spots, but the image as a whole instantaneously.

A great number of devices in order to achieve the end in view on these principles was invented. It will be possible to describe only a few of the most representative.

Szczepanik's Apparatus.

Fig. 51 shows the apparatus of Jan Van Szczepanik,

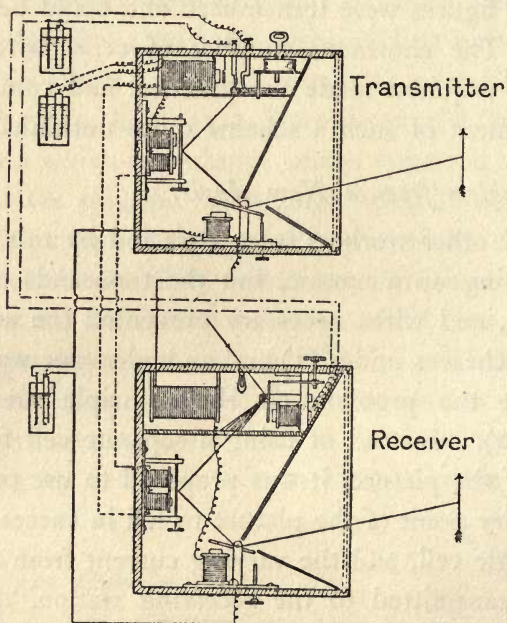


FIG. 51.—Szczepanik's Television Apparatus.

in which the image traverses the cell. At the transmitting station two mirrors are employed, vibrating at right angles to each other, the image being projected by the lens, first on to one mirror and from this mirror on to the second one, which in turn reflected it on to a Selenium cell. The result of the combined

motions of the mirrors was to cause the image to travel over the cell in a zigzag path, and the current from the cell was transmitted to the receiving station where it controlled the intensity of a spot of light, this point of light being reflected in a zigzag path across a screen by means of two mirrors vibrating at right angles in the same way as the mirrors of the transmitter.

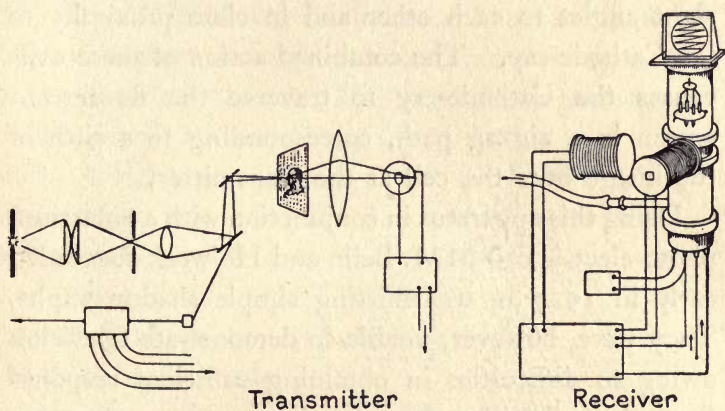


FIG. 52.—Apparatus of MM. Belin and Holweck.

MM. Belin and Holweck and the Cathode-ray.

Fig. 52 shows the apparatus of MM. Belin and Holweck, who employ at their transmitting station two mirrors vibrating at right angles to each other in a manner somewhat similar to that suggested by Szczepanik, these mirrors causing the image to traverse a potassium photo-electric cell. The current from this cell controls the intensity of a Cathode-ray at the receiver, the ray being caused to traverse a fluorescent screen by magnets which are energised

from an alternating current transmitted from a motor that moves the mirrors at the transmitter.

Synchronism is obtained by the use of two synchronous motors, one synchronous motor having a low periodicity drives the slowly vibrating mirror, and the other with a high frequency drives the rapidly vibrating mirror. At the receiving station, the currents from these motors pass through two coils at right angles to each other and in close proximity to the Cathode-ray. The combined action of these coils causes the Cathode-ray to traverse the fluorescent screen in a zigzag path, corresponding to a path of the image over the cell at the transmitter.

Using this apparatus in conjunction with a potassium photo-electric cell MM. Belin and Holweck succeeded early in 1927 in transmitting simple shadowgraphs. They were, however, unable to demonstrate television owing to difficulties in obtaining sufficient response from the cell with reflected light.

M. Dauvillier's Apparatus.

M. Dauvillier has conducted extensive experiments along similar lines, using potassium cells and the Cathode-ray for reception purposes and two vibrating mirrors as the exploring device. He describes his difficulties as being chiefly those connected with the potassium electric cell, and, like MM. Belin and Holweck, while he was able to transmit shadows, he found it impossible to transmit by reflected light. Writing in the *Proceedings of the French Academy of*

Science in August 1927 he states: "No object normally illuminated from the exterior diffuses sufficient light to make an impression on the apparatus, and it would have to be a thousand times more sensitive to make it utilisable."

Mihaly's "Telehor."

In Austria, Denes Von Mihaly uses a device which he calls a "Telehor," both to explore his image at the transmitting end and to traverse the receiving screen at the receiving station. The principle employed may be explained by

means of Fig. 53.

Essentially the apparatus consists of a little mirror, *P*, actuated by an oscillograph, the oscillograph being also given a fur-

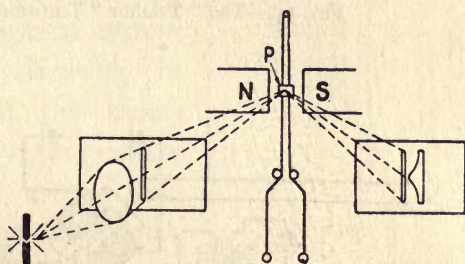


FIG. 53.—Explaining the Principle of Mihaly's Telehor.

ther motion at right angles, so that the mirror oscillates with movements of vibration of different frequencies about two perpendicular axes—horizontal and vertical. By means of a powerful lens system, a very small image of the object to be transmitted is thrown upon this minute mirror, which is set at 45° to the optic axes. The beams of light after forming the image are reflected through a right angle upon a diaphragm and the motion of the mirror causes the

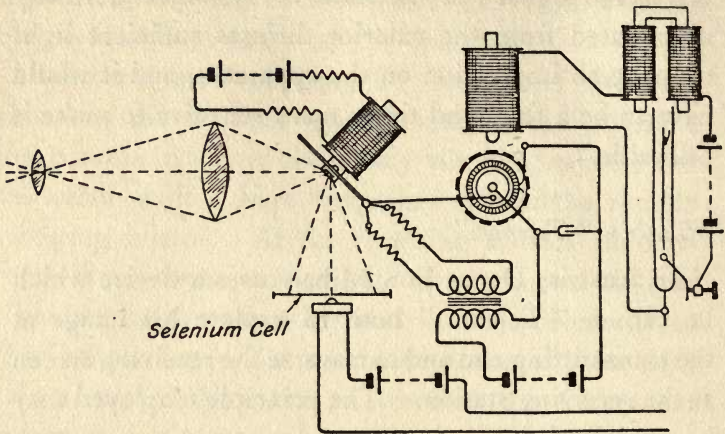


FIG. 54.—The "Telehor" Transmitter Circuit.

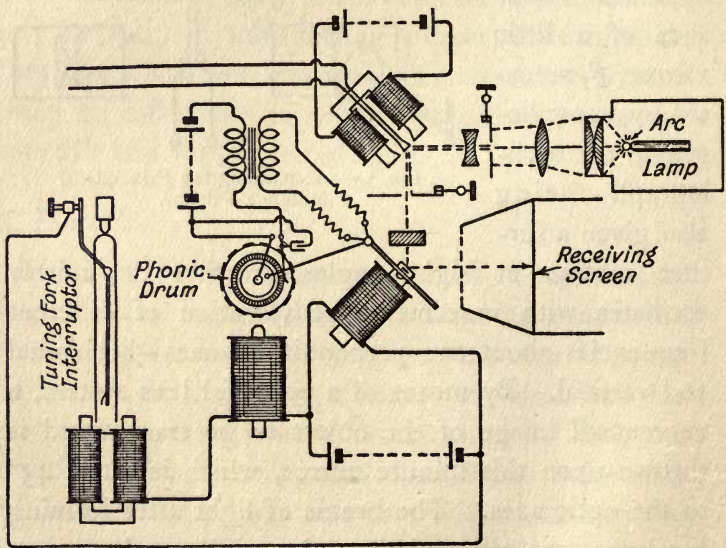


FIG. 55.—The "Telehor" Receiving Circuit.

image to traverse a slot in this diaphragm, behind which is a light-sensitive cell. The diagram of the transmitter circuit is given in Fig. 54.

At the receiving station the current from the cell controls the motion of a mirror mounted upon an oscillograph (Fig. 55). The vibration of the mirror causes more or less light to pass through an aperture in a diaphragm. An image of the aperture is caused to traverse a screen by an optical system similar to and vibrating in synchronism with the transmitting device. Synchronism is obtained by the use of two special devices: the tuning-fork interrupter, and the "phonic drum" of La Cour (Figs. 56 and 57).

Mihaly claims to have transmitted simple geometrical silhouettes, but his optical device, from the description given, appears to be unsatisfactory in principle. No clear image, but rather a blur, would be formed by the combina-

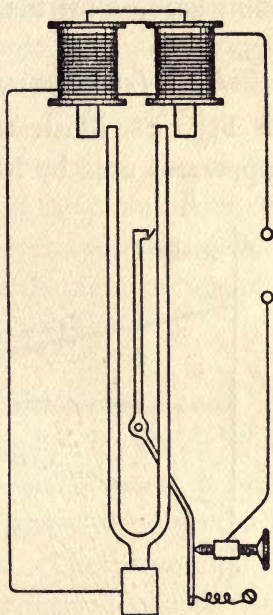


FIG. 56.—The Tuning-fork Interrupter.

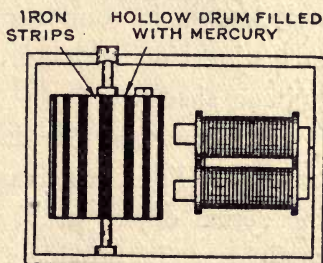


FIG. 57.—La Cour's Phonic Drum

tion described, as the image projected upon the mirror would be out of focus on the diaphragm. This, in conjunction with the inertia of the Selenium, may possibly account for the unsatisfactory results obtained.

Jenkins' Television of Shadowgraphs.

Fig. 58 illustrates the principle on which the apparatus used by Messrs. Jenkins and Moore works.

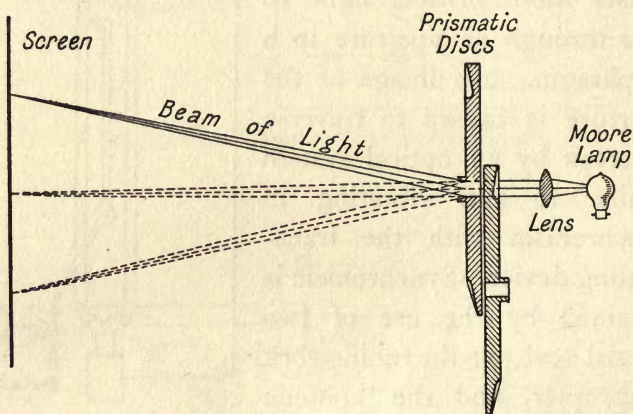


FIG. 58.—Explaining Principle on which the Jenkins' Apparatus works.

In the United States, Mr. Jenkins, whose name is well known in connection with phototelegraphy, has, in conjunction with Mr. Moore, succeeded in transmitting shadows.

In transmitting the shadow of an object, we can use unlimited light, whereas, in transmitting images of the actual object itself, only an infinitesimal light is available. To provide a light-sensitive device capable of responding instantaneously to this infinitesimal light was the outstanding problem to be solved in order that

television could be regarded as achieved. This, the apparatus of Messrs. Jenkins and Moore has failed to accomplish. The important feature of the apparatus, however, and one which deserves particular notice is the prismatic disc used for exploring purposes, a remarkably ingenious device invented by Mr. Jenkins. This consists of a circular glass plate, the edge of which is ground into a prismatic section, the cross-section varying continuously round the circumference. As the nature of this device deserves special mention, it will be more fully discussed in the next paragraph.

Jenkins' Prismatic Disc.

In the early attempts at television mentioned in this book, a rotating glass cylinder in which was placed the source of light was usually made use of, the cylinder being rotated and given a longitudinal motion at one and the same time. The photographic film was wrapped round the revolving cylinder so that the rays from the source were always directed radially. As a flat screen placed vertically is used in the Jenkins' system, obviously the employment of a revolving glass cylinder is out of the question and some form of glass prism for bending rays of light is necessary. This latter therefore takes the form of a specially made combination of disc and prism known as the Jenkins' Prismatic Disc. Fig. 59.

The disc itself is made of a mirror glass, the prismatic lens being ground into the face of the disc, the latter thus having its own support on the shaft on which it is mounted.

The prism has its base inward from one end to a point midway round the periphery of the disc, thence it has its base outwards round to the end of the half-section, the slope being gradual from start to finish, first one way and then the other. Since this prism varies in thickness, it is really better in functioning than many single lenses; a beam of light is by its

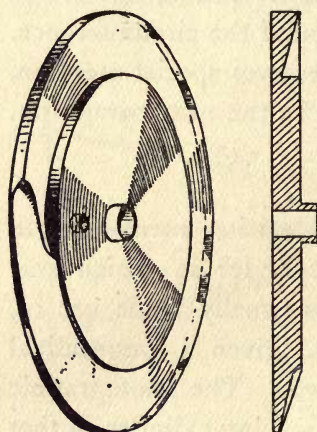


FIG. 59.—Jenkins' Prismatic Disc.

action swept across or oscillated from one side to the other of the picture or screen. The device will be better understood by reference to the diagram. A beam of light passing through such a disc is bent backwards and forwards as the disc revolves, and by using two of these discs at right angles, one to give a lateral movement and the other to give a perpen-

dicular, the image is made to traverse a potassium photo-electric cell at the transmitting station. The current from this cell is transmitted to the receiving station, where it controls the light from the lamp invented by Mr. Moore. This lamp changes its intensity instantaneously in proportion to the current, and its varying light is caused to traverse a screen by a device similar to that at the transmitter.

The Moore Lamp.

The Light Source is a special type of electric glow discharge lamp invented by Mr. Moore (Fig. 60), this lamp giving a light spot of great brilliancy. Using this apparatus in conjunction with a Potassium Photo-electric Cell, Messrs. Jenkins and Moore were able to transmit shadowgraphs successfully. It is placed outside the light-tight box or cabinet in which the other receiving parts, such as discs, etc., are contained. The lamp is a modified form of Neon tube the discharge being concentrated in the small hole in the central electrode.

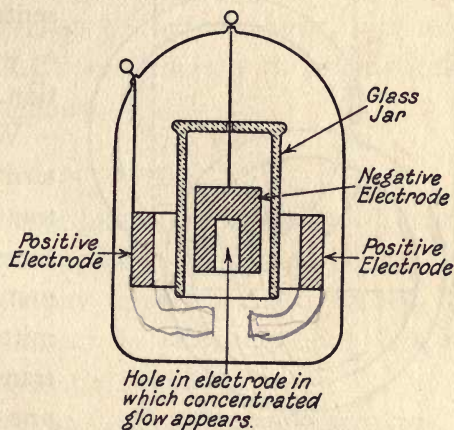


FIG. 60.—The Moore Lamp.

When the received currents are passing they vary the brilliancy of the discharge in accordance with the degree of intensity sent out at the transmitting end. The rays are focussed on to a ground-glass screen after passing through the prismatic discs and so produce the picture.

Method of Operation.

Two prismatic discs are used in transmission, each revolving at different speeds, and one disc is set at right angles to the other, the effect of the light rays being to draw very close lines across the picture.

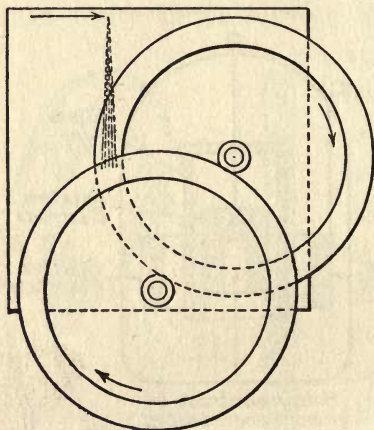


FIG. 61.—Illustrating how the Beam of Light traces out Lines across the Screen.

This action is represented in Fig. 61 as a side view or elevation.

When a magic lantern is used for the transmission of pictures, it is obvious the picture to be transmitted must be a transparent one, *i.e.* one depicted on a slide, to transmit an actual scene natural or artificial

light reflected from the scene must be used.

For transmitting motion pictures, however, the magic lantern is replaced by a motion picture projector and the light rays transmitted by the motion picture are concentrated by the lens projector and then focussed, after passing through the discs, on to the light-sensitive cell.

The operations at the receiving end are very similar. When the transmitted currents are received they vary the illumination of the lamp in the same manner, and these variations on being sent through a rotating disc

at the receiving end trace out a series of parallel lines on the receiving screen.

The synchronism of the transmitting and receiving apparatus is effected by means of synchronous motors driven from the alternating current supply-mains, both receiver and transmitter motor being supplied from the same A.C. generator. Jenkins did not synchronise by wireless or by telephone, but took advantage of the A.C. power supply to automatically synchronise his machines.

Dr. Alexanderson's Experiments.

Dr. E. F. W. Alexanderson, of the General Electric Company, Schenectady, New York, has, besides inventing phototelegraphy apparatus, also turned his attention to experiments in television, but lays no claim to having solved the problem.

Early last year (1927), Dr. Alexanderson read a paper before the American Institute of Electrical Engineers, in which he described his television system without, however, giving a demonstration. He explores the image by means of a rotating mirror polyhedron, each mirror being set at a slightly different angle from that proceeding it, the image being cast upon the revolving polyhedron by a lens and reflected upon a light-sensitive cell. To obtain more detail, Alexanderson suggested dividing his image into zones and using a plurality of cells with a corresponding plurality of light sources at the receiver.

His receiving station consisted of a similar optical arrangement to that at his transmitter, light sources

replacing cells and a screen replacing the object being transmitted. His fluctuating light he proposed producing by means of high speed shutters controlled by oscillographs.

Synchronism was to be obtained by the use of synchronous motors.

The transmitting apparatus consists of a revolving wheel or drum about $2\frac{1}{2}$ feet in diameter which carries twenty-four mirrors 8 by 4 inches on its 10-inch flanged periphery. The drum is direct-coupled to a motor running at a high speed. There is a lens for focussing the image and a brilliant source of light from which seven beams of light radiate and consequently seven spots of light traverse the picture or scene to be transmitted. In addition, at the transmitting end, seven photo-electric cells are required. The arrangement of screen, revolving mirrors with lenses, and light sources is shown in Fig. 62.

Alexanderson is experimenting with this apparatus by the use of seven distinct wave-lengths, each carrying a crude image. Each of these crude images will be blended at the receiving end into one perfect image of good definition, *i.e.* no blurring of outline.

The reason for using seven light beams instead of one is because of Dr. Alexanderson's contention that it is impossible sufficiently to illuminate a large screen with a single spot of light in the small space of time required in television work. The mechanical inertia of the apparatus militates against the attainment of such an object. The gain in the amount of illumination thus varies directly as the square of the number

of light sources, since with seven light sources and seven spots of light 49 times as much illumination will be obtained in the same interval of time. Moreover, there will be 168 light-spot traversals over the screen for every revolution of the mirror drum, since there

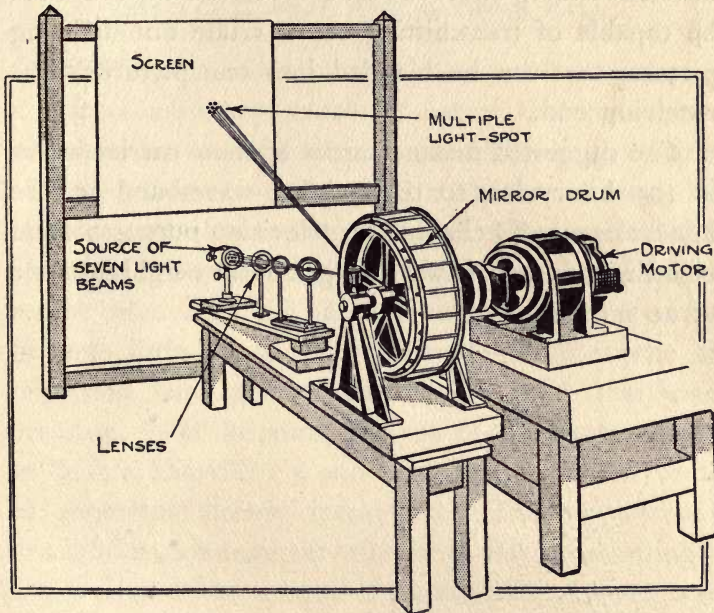


FIG. 62.—Alexanderson's Apparatus (reproduced by kind permission of the *Wireless World*).

are seven light sources and 24 mirrors. A further advantage lies in the fact that seven spots of light will traverse the whole of the screen in one-seventh of the time that it takes one spot to do so.

As the mirrors revolve these seven beams trace seven lines of light simultaneously, at, say, the top section of the screen and then perform the same operation over the next section, and so on until the whole of the

screen has been traversed. Each of the seven light-spots traces its own picture and has to be controlled independently from the transmitting end. It is for this reason that the seven photo-electric cells are required. Hence a multiplex radio system of transmission sending out seven different carrier waves should be capable of transmitting seven crude but differing pictures that can be blended into one picture at the receiving end.

The suggested distance apart of these carrier waves is 100 kilocycles, so that with a wave-band of 700 kilocycles a radio channel for television purposes could be utilised on a short wave-length in the neighbourhood of 20 metres.

CHAPTER VI

RESEARCHES WITH THE CATHODE-RAYS

Historical.

THERE are many secrets of nature that have been unlocked by modern science, especially in the realm of the infinitely small, such as those revealed by investigation into the structure of the atom and the electron, the detection of invisible rays, and other recent discoveries. The enlistment of some of these hitherto little-known phenomena into the service of television has been attempted on more than one occasion. For instance, the use of the Cathode-rays in Belin's, Dauvillier's, and Campbell Swinton's forms of apparatus already mentioned. The employment of Cathode-rays together with other aids is exceedingly interesting as the unique characteristics of these rays suggest to the inventive mind many possibilities. A brief glance at their properties and marvellous behaviour should therefore prove of service.

Cathode-rays were first brought to notice when men began to experiment with vacuum tubes and the properties of vacuous spaces generally and in particular the phenomena associated with electric discharges in a glass tube from which air had been evacuated. The advances made in this direction have been due largely to the researches in high vacua by

Gaede in Germany, Langmuir and Dushman in America, Knudsen in Denmark, and Dewar and N. R. Campbell in this country.

The Phenomena of the Discharge Tube.

It is well known that if a closed glass tube with a metal disc electrode sealed into each end, *i.e.* a Cathode plate and an Anode plate (Fig. 63), be connected to a high vacuum pump, after the first reduction of pressure a form of a "spark" discharge will pass which only requires for its production a small applied P.D. between the electrodes. The discharge consists of

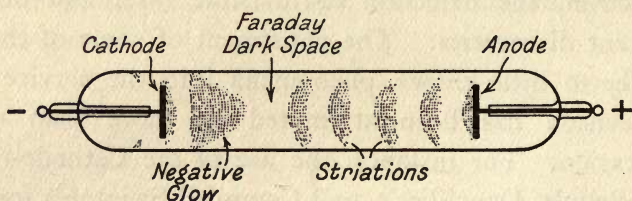


FIG. 63.—Electric Discharge in an Exhausted Tube.

negative charges of electricity—electrons. This discharge soon changes when the pressure of the gas is reduced. Exhaustion of the discharge tube beyond $1/100000$ th or 100-millionths of an atmosphere causes rapid changes in the discharge phenomena. It is then possible to detect luminous streamers which appear to proceed in a direction from the Cathode and penetrate a short distance along the length of the tube. Still further reductions of pressure approaching 10-millionths of an atmosphere make the walls of the tube show a bright green fluorescence. A suitable object interposed in that part known as the Crookes' dark

space causes a sharp shadow of it to appear on the walls of the tube. Goldstein gave this phenomenon or stream of radiation from the Cathode the name "Cathode-rays."

Properties and Characteristics of Cathode-rays.

These Cathode-rays are deflected by a magnetic field, the usual method of applying the field being by means of a short solenoid coil of about 6 inches

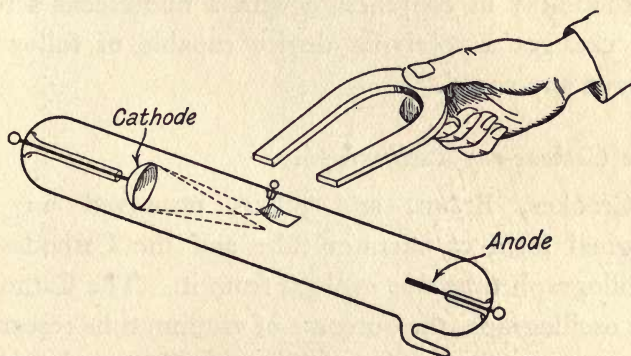


FIG. 64.—Deflecting Cathode-rays by Magnet.

diameter, a fact first discovered by Dr. Fleming. A horse-shoe magnet will produce the same effect.

An interesting experiment may be performed by making use of a concave Cathode which focusses the rays, thus converging them to a point. Now Cathode-rays when focussed on any material substance produce great heat—glass is melted, platinum foil rendered red-hot, etc.—due to the impact of electrons. If therefore a piece of platinum foil is hung inside the tube, but not too near the focus of the rays, an ordinary horse-shoe magnet will deflect the rays so as to bring the

focus on to the foil and raise it to a bright red heat (Fig. 64).

The rays are produced in the form of a thin, pencil-like discharge and this pencil of rays can be moved in any direction, either magnetically or electrically. It has no weight and therefore no inertia, and there is no limit to the speed at which it can travel. When this pencil of rays strikes a plate of fluorescent material, a brilliant spot of light is produced so that by using the Cathode-ray in conjunction with a fluorescent screen we can get a receiving device capable of following almost any speed.

The Cathode-ray Oscillograph.

Crookes, Braun, and others improved on the original form of vacuum tube and the Cathode-ray oscillograph tube was evolved from it. The Cathode-ray oscillograph, the outcome of vacuum tube research, is unsurpassed as an inertia-free recorder, having been used for studying the wave-form and purity of high frequency currents like those obtained in line telephony and in wireless practice with conspicuous success.

The likelihood of Cathode-rays serving a useful purpose in experimental television may be appreciated perhaps more readily by glancing at the construction of a typical Cathode-ray tube. Fig. 65 gives a general idea of the form and construction of such a tube. It differs a little from the early forms of tube in that the source of electrons is a hot filament instead of a gas discharge. The inside of the tube at its large

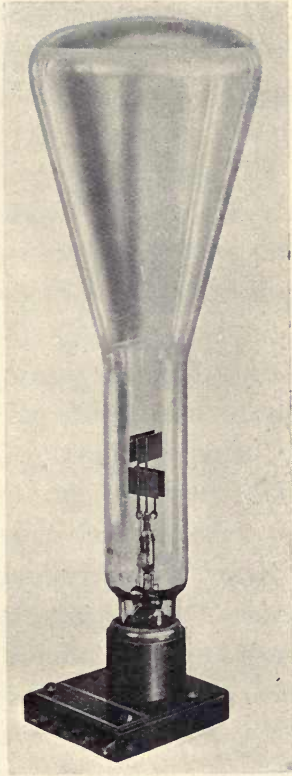


FIG. 65.—The Cathode-ray Tube
or Oscillograph.

[To face page 112.]

end is coated with a fluorescent substance—a mixture of calcium, tungsten, and zinc silicate. The spot where the electrons strike is thus rendered bright and luminous for visual observation. The focussing of the ray on the fluorescent screen is brought about merely by adjustment of the filament current, usually about 1.3 to 1.5 amps. being consumed by the filament when the beam of electrons is correctly adjusted. The filament is heated by a 4- or 6-volt accumulator.

During the last few years there has been extensive development both in the construction and technique of application of the Cathode-ray tube. With present-day apparatus, a single spot of light can be seen by the eye traversing the fluorescent screen at a rate of between 200 and 300 miles an hour.

Subsequent to the discovery of Crookes' tube, Braun's tube, and their modern development—the Cathode-ray Oscillograph—several inventors conceived the idea of utilising the Cathode-ray by deflecting it a great number of times per second for the purpose of producing a series of dots on a screen so many times a second, persistence of vision being relied on to give a defined image. MM. Belin and Holweck's and M. Dauvillier's apparatus and their application of the Cathode-ray in attempting to solve the problem of television have already been outlined in the last chapter; in the present chapter a few other types of apparatus employing the Cathode-rays are now given.

Rosing's Attempts with the Cathode-ray.

Acting on the ideas inspired by such a promising ally in field of television research as the Cathode-ray, Boris Rosing, a Russian professor, in 1907 brought out a device of a novel and interesting character. His transmitting arrangements were similar in principle to the others, but his receiving device was very original,

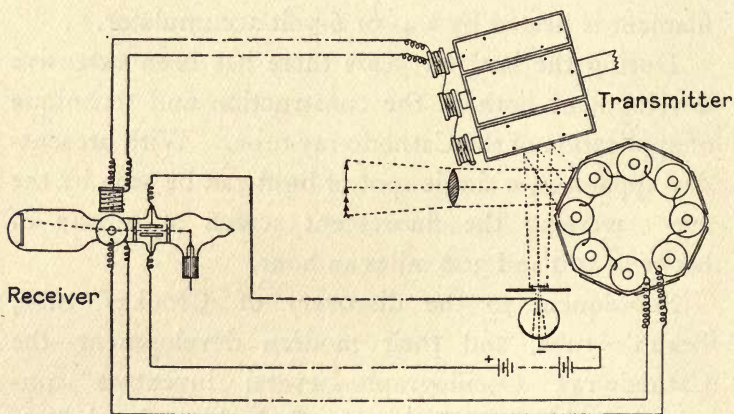


FIG. 66.—Rosing's Apparatus.

as he dispensed altogether with mechanical parts and used instead the Cathode-ray. Rosing used as his transmitter two mirror polyhedrons revolving at right angles to each other, their combined motion causing an image of the object transmitted to pass over a light-sensitive cell (Fig. 66). The varying current from the cell was transmitted to the receiver, and here it passed through a magnet which deflected the Cathode-ray away from an aperture placed in its path, the amount of the ray which passed through being proportional to the current passing through the magnet cell. This ray was

caused to traverse a fluorescent screen by currents sent out from coils joined to the mirror polyhedrons. By this means he abolished mechanical inertia at his receiver but not at his transmitter.

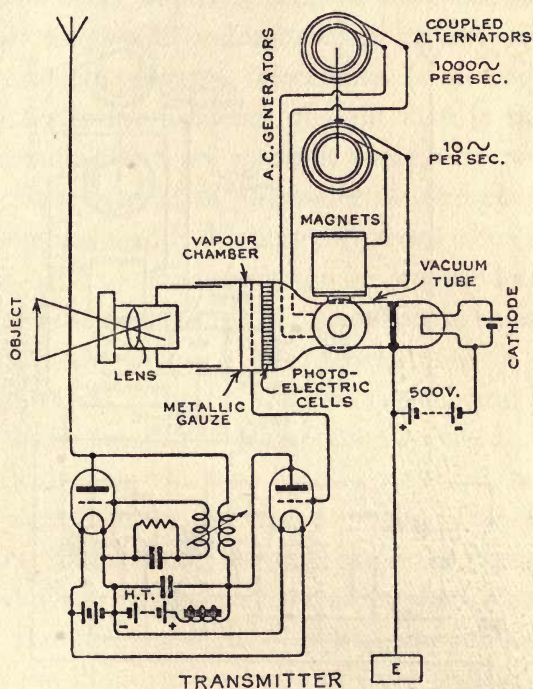


FIG. 67.—Proposed Construction for using Cathode-rays in Television. Transmitting Circuit.

Mr. Campbell Swinton's Suggestion.

In this connection it should be noted that Mr. Campbell Swinton published a letter in *Nature* prior to the publication of Rosing's device, and in this letter he suggested a design of apparatus in which Cathode-rays could be both at the transmitting and receiving

ends. And, further, in an address given before the Rontgen Society in 1911, he pointed out that by employing an imponderable agent of extreme tenuity like the Cathode-ray, the difficulty of securing the essential feature of extremely rapid and accurate

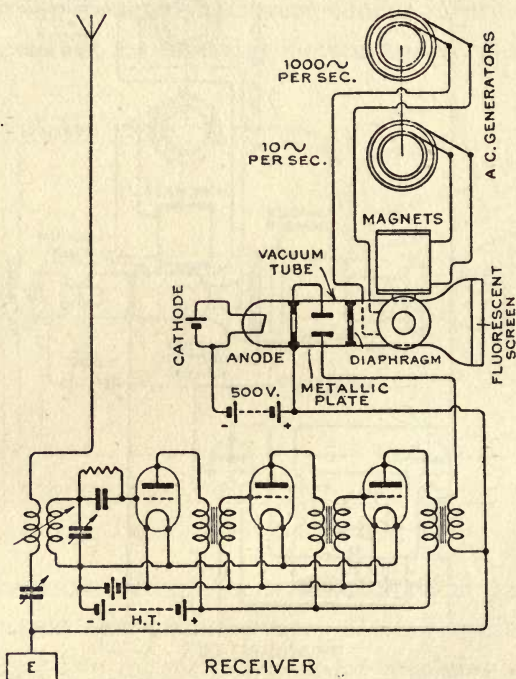


FIG. 68.—Proposed Construction for using Cathode-rays in Television. Receiving Circuit.

motion required with mechanical parts could be removed.

Mr. Campbell Swinton proposed to use at the transmitting and receiving ends of his apparatus a Cathode-ray tube having the Cathode itself heated by one or two cells (Figs. 67 and 68). At both ends the Cathode-

rays impinge on screens. At the transmitting end the screen consists of a number of small cubes of potassium (or rubidium) surrounded with insulating material, thereby forming a mosaic. On the one side of this screen the rays impinge, and on its other side is a chamber filled with sodium vapour or any other gas that conducts negative electricity (electrons) more readily under the influence of light than in the dark. The metallic cubes are made of potassium, rubidium, or other strongly active photo-electric element because such elements readily discharge electrons when exposed to light. Upon this mosaic can be projected an image of the scene to be transmitted, the mosaic to be traversed by a Cathode-ray, each cube discharging in turn as the ray travels across it, the discharge being proportional to the amount of illumination received. In the case of cubes on which no light is projected, no action takes place, but in the case of those cubes that are brightly illuminated by the projected image, the negative charge imparted to them by the Cathode-rays passes through the ionised sodium vapour along the line of the illuminating beam of light until it reaches the screen, whence the charge travels to the plate of the receiver. This plate on becoming charged acts on the Cathode-rays in the receiver. The fluctuating current thus produced controls the intensity of the Cathode-ray at the receiver, this Cathode-ray traversing a fluorescent screen in synchronism with the ray at the transmitter, mechanical exploring devices being thus dispensed with at both receiver and transmitter. Cathode-rays can be bent by the action of a magnet, and

therefore by synchronously deflecting the two beams of Cathode-rays, one at the transmitting end and the other at the receiving end, the varying magnetic fields of two electro-magnets are set up. The electro-magnets are placed at right angles to each other and supplied with alternating current of widely different frequencies. This causes the two beams to sweep over the picture surface in a tenth of a second (the maximum limit for visual persistence). At the receiving end the screen on which the beam impinges must be a sensitive fluorescent substance, so that variations in the intensity of the rays cast on the screen produces a replica of the picture transmitted.

CHAPTER VII

IMAGES AND THEIR FORMATION

THE results of modern research of radio seeing seem to indicate quite definitely that with the present means at our disposal an image of the scene or object must be formed before the transmission can be attained with any degree of success, and it is the perfecting of the means and devices for transmitting and receiving this image that enables television to be successfully accomplished.

The study of Optics assists very considerably in following out the ideas and principles applied, and therefore a few cursory remarks on the theory of light and its transmission may prove helpful.

It is proposed to recount the principles on which images are formed preparatory to a description of the latest developed system of television so that the practical application may be understood more readily.

Light-Sources and Illuminants.

Before we can see a body, it is necessary for it to be either self-luminous, that is to say, the minute particles of which it is composed must themselves set up the vibrations of waves that affect the eye, or the body itself must be capable of reflecting light from some self-luminous source. Thus the sun is a self-luminous

body, but the moon is rendered luminous by reflecting the rays of light that stream upon it from the sun. In television we are mainly concerned with the latter kind of luminosity. Whether we transmit a daylight scene or a scene in a darkened room, it is the rays of light thrown on to the scene, either those proceeding from the sun or from an artificial source of light, that render it possible to transmit the scene.

The sun, a lighted candle, an electric glow lamp, a fire-fly, are objects which are said to emit light, *i.e.* are self-luminous. These self-luminous bodies are not only seen directly by the eye by virtue of the rays proceeding from them, but they render visible all surrounding objects that are not self-luminous, such as the articles of furniture in a room when an electric lamp is switched on. The rays of the latter being transmitted in all directions fall on non-luminous bodies like the walls and furniture and the rays are thrown back or reflected so as to reach the eye.

How Light Travels.

Light, or to speak more broadly radiation, is, according to modern ideas, believed to consist of electro-magnetic waves set up by vibrations of the minute entities that compose its source and transmitted by wave motion through the all-pervading medium known as the ether. Light is definitely known to travel at an inconceivable speed, faster than that of any moving material body. Calculations made during astronomical observations and measurements carried out with optical apparatus confirm this state-

ment. The accepted figure for the speed of light is 186,000 miles per second in all directions. A ray of light from the sun (92,700,000 miles distant) thus takes about eight minutes to reach the earth. Its speed is equivalent to that of a body going round the earth seven and a half times in one second.

The question arises—How does this energy travel so vast a distance? We can only imagine two methods:—

(1) By movement of matter through space (Corpuscular Theory).

(2) By a handing on of energy from point to point (Wave Theory).

Hertz' Experiments in Electro-magnetic Radiation.

The mode by which radiant light and electricity, which are now regarded as one, travel is not known to us for a certainty. Hertz, however, in his classical experiments was the first to show that they are identical when oscillations of electric current are set up across an air-gap; such oscillations produce waves in the neighbouring ether just as a tuning-fork sets up waves of sound in air. Hertz detected these waves by suitable apparatus, investigated their properties, and in particular clearly demonstrated that they are propagated with a velocity of 3×10^{10} cm. per second. This value is the same as that obtained for the velocity of light. Hence electro-magnetic radiation, or the setting up of electro-magnetic waves, has all the properties of light, with the only difference that it is on an enormously greater scale. Therefore we may

conclude that light is electro-magnetic radiation set up by the vibrations of the infinitely small particles that constitute the source, and on account of their minuteness send out very much shorter waves and accordingly waves of far higher frequency than the Hertzian waves.

From a certain phenomena in connection with photo-electricity it seems very probable that there is a kind of corpuscular theory of light.

The wave-theory of light, however, has hitherto held the day, and all practical experiment and calculations have so far demonstrated that the hypothesis is a workable one ; it serves as a foundation on which the superstructure of light in all its practical applications can rest.

Light Waves.

The wave theory of light perhaps gives rise to some difficulty in accepting the view that light is due to wave-motion. Our everyday ideas are that wave motion will travel round corners, especially in the case of sound, whereas light when it meets an opaque obstacle casts a sharp shadow. This is explained by the difference in length between a sound wave and a light wave. Sound waves are ordinarily a metre or so long, light waves only one twenty-thousandth of a centimetre. If we could only have the objects enormously large in the case of sound waves and extremely small in the case of light waves, a more accurate idea and comparison could be conceived. For example, when a church bell is sounded and a house is

the obstacle, a very marked sound shadow is formed, the sound being much less intense if the hearer stands with the house between him and the bell. This may be observed in a still greater degree if a shadow is formed by a hill to the sound waves from a big explosion. On the other hand, if the shadow thrown by a small sharp-edged object placed in front of a brilliant source of light be examined by a fairly high power eye-glass, it will be found that a little light does get behind the edge.

The shadow of a needle or a hair when light from a single point or a single narrow slit is incident upon it is found to be, not a fine black shadow, but, on the contrary, a shadow with curiously fringed edges and with a line of light right throughout the very middle of the shadow, which is caused by the light waves passing by it, spreading into the space behind, and meeting there.

This is the chief feature about light-waves, namely, their very small length; but even the shortest of them differ in size. In consequence of this latter feature, some are so small that the human eye cannot detect them—the mechanism of the eye is not adapted for their frequency of vibration to effect the sensitivity of the optic nerve and thus convey any impression to the brain without artificial aid. Hence there are visible and also invisible rays. This will be referred to more fully later on.

The difference in size of the waves is called their wave-length, that is, the length from the crest of one wave to the crest of the next (Fig. 69), and since the

creation of short waves involves a greater frequency of vibration or movement than the creation of long waves,

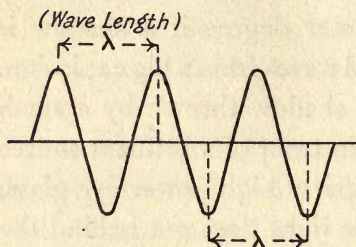


FIG. 69.—Wave-length.

it is now becoming the fashion to measure all physical phenomena involving wave motion in frequencies. The velocity or speed of light, however, whether the waves are short or long, remains the same,

and the equation—

$$\text{frequency} = \text{velocity}/\text{wave-length}$$

holds good in all cases.

Lights and Shadows.

If an object intercepts the rays of the light proceeding from any source, we obtain what is known as a shadow

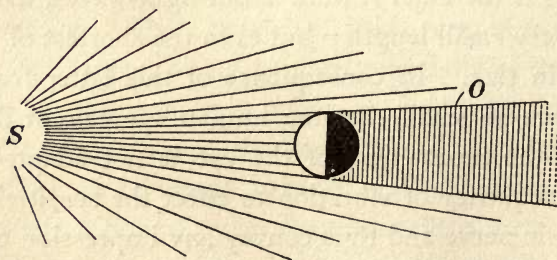


FIG. 70.—A Shadow Cone.

of that object. This result is not desired in true television. For example, let S denote a source of light and let an opaque body be placed in the path of the rays of light proceeding from S (Fig. 70). Since

the rays that fall directly on the opaque body are blocked and those that just pass it are not bent, it follows that a *darkened* cone, *O*, extends beyond the opaque body called a shadow cone and any point within this cone receives no light from *S*. A screen placed at right angles to the axis of the shadow cone will show a well-defined shadow of the object. Very sharp shadows are formed when a naked arc light is the source.

If the source of light is large in comparison with its

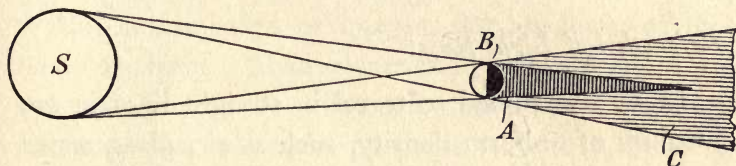


FIG. 71.—Umbral and Penumbral Shadow Cones. (A, Umbral; B, Opaque Sphere; C, Penumbral.)

distance from the object, the rays from every point on the source go to form a separate shadow cone from the object, and it is only the space common to all these shadow cones which is free from light. Compare the sections of the shadow cones *A* and *C*, termed the *umbral* and *penumbral*, respectively, thrown from an opaque sphere, *B*, by light from opposite points of an extended source, *S* (Fig. 71).

The foregoing accounts of Lights and Shadows, although perhaps given in rather an elementary form for the benefit of readers unacquainted with optics, will enable us to see clearly the difference between true television and the systems that have already been demonstrated as such. For true television, we need

to have an *image* formed of the scene to be transmitted. The light from some source must be reflected from all points on the scene and be brought by means of a lens to form an image. True television means the transmission of the image of an object with all gradations of light, shade, and detail, so that it is seen on the receiving screen as it appears to the eye of an actual observer. Images may be formed either by one or more lenses or by means of mirrors, as we shall see in the following paragraph.

Refraction of Light Rays.

Light is assumed to travel in straight lines in any medium of uniform density, such as air, glass, water, etc., but in travelling from one medium to another it suffers deviation on account of its refraction at the surface of the separation of the two media.

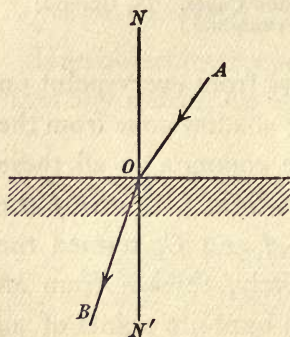


FIG. 72.—Incident and Refracted Ray. (In Refracted Light the Angle of Incidence is equal to the Angle of Reflection.)

Let AO (Fig. 72) represent a ray of light passing through air and incident at O on the surface of a piece of glass, and let OB represent the refracted ray. Then the angle AON is called the angle of incidence and

BON' the angle of refraction, where the straight line NON' represents the normal to the surface at O . It is for this reason that an image can be formed by a lens.

Images.

When an object or body is seen by the eye, what is known as an image of the object is thrown on the retina where the nerve-centres convey the impression to the brain. It is this image or concentration of all the light rays proceeding from the object that produces vision. Hence in television before a scene or object can be transmitted any distance, an image of it must be formed, otherwise we get a shadow of the object and the successful results achieved in television are due to this transmission of images, not shadows, of the scene or object. Shadows are easily transmitted, as we saw in Chapter V. The best method of forming an image for television purposes is to use either a mirror or a lens.

Mirrors and Lenses.

If we have a mirror with a surface that bulges out, it is called a convex mirror (Fig. 73). If it is hollowed

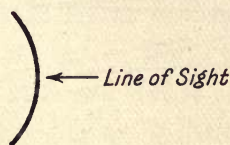


FIG. 73.—A Convex Mirror.

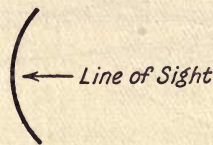


FIG. 74.—A Concave Mirror.

out, it is called a concave mirror (Fig. 74). A convex mirror will cause a divergence of the rays; they appear to come from a virtual focus from behind the mirror

(Fig. 75), but no real image is formed. If a concave silvered mirror be placed in a beam of light from any

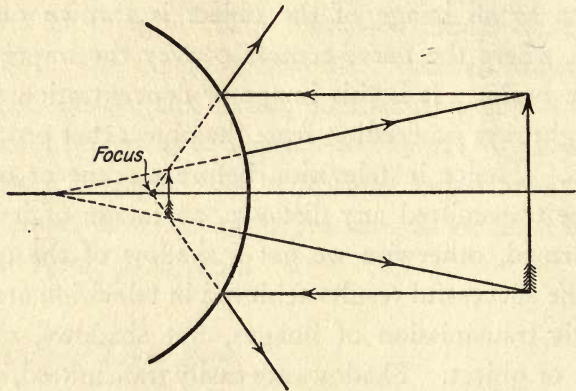


FIG. 75.—Image formed by Convex Mirror.

source, it will cause the rays to be focussed at a point in mid-air (Fig. 76), forming a real image. With a

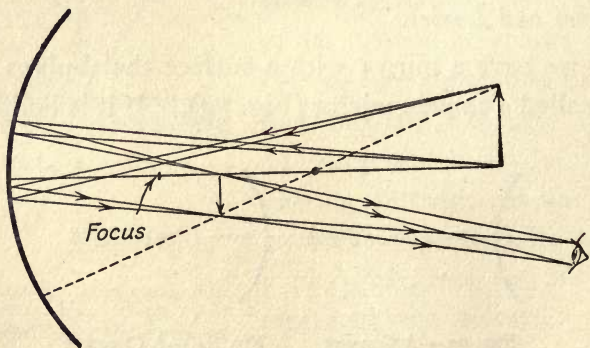


FIG. 76.—Image formed by Concave Mirror.

piece of glass that is thicker in the middle than at the edge—a convex lens—the waves or rays converge to a focus and a real image can be formed. With a piece

of glass that is thinner in the middle than at the edges—a concave lens—the effect is just the opposite, the wave will emerge as a bulging wave as if diverging from some virtual focus and no real image is formed.

A lens may thus be regarded as a combination of two refracting surfaces either of which may be convex, plane, or concave.

If we consider light to be transmitted by means of wave-motion, it is quite easy to understand many of the laws and phenomena that are connected with it. For example, the reflection of light from a plane or curved surface that is polished

is simply a re-bounce of the waves that impinge on the surface. Light travels more slowly in glass than in air, so that in consequence it follows quite simply that if the waves strike obliquely against the surface of a glass, that part of the wave-front that strikes the glass first will go more slowly after entry and the other part which is going on a little longer time in air gains on the part that entered first, so that the direction of the wave-front is changed and the line of march is also changed. This may be made clear by the aid of Fig. 77.

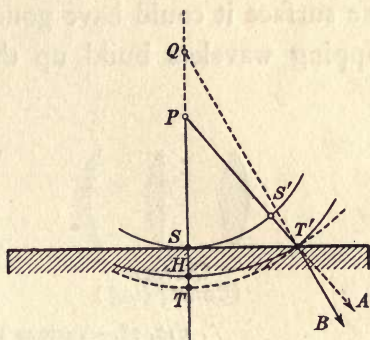


FIG. 77.—Illustrating Refraction of Light.

If waves of light from P strike against the surface of a thick glass plate a wave reaches SS' . A little later

it would (in air) reach TT' ; but it has struck a denser medium (glass) and the part of the wave that enters first will only reach H , or two-thirds of the distance.

A set of arcs can be described by means of compasses to represent the various wavelets, the arc in each case being made only two-thirds of the distance that the wave of light would have had to go if after passing the surface it could have gone on to TT' . The overlapping wavelets build up the new wave-front HT' ,

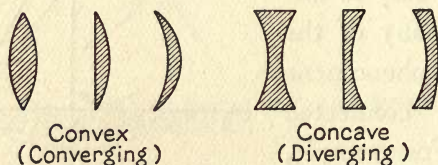


FIG. 78.—Various Types of Lenses.

which is a much flatter curve having its centre at Q . The wave therefore will appear to proceed from this point. Again, the wave-front that has travelled in the direction PT' has its direction changed—instead of going along $T'A$ in a straight line it takes the course $T'B$ as if it had come from Q . This sudden change in its path caused by a ray of light entering a denser medium is known by the name of *refraction*.

This property of refraction can be used to converge light to a focus. For example, if we take a piece of glass that is thicker in the middle than at the edges then we can use it to form a real image.

Glass is the medium used in focussing the object and

forming an image for television purposes, and when made in the form of a solid with spherical surfaces, *i.e.* either a convex or concave lens, is capable of converging or diverging the rays of light passed through it. In television, since the rays have to be converged, convex lenses only are necessary. Fig. 78 shows sectional views of the forms that lenses may take.

CHAPTER VIII

THE BAIRD TELEVISOR

THE systems described so far have in a few cases enabled shadows to be transmitted, but all have failed to produce true television, which was first attained by the apparatus invented by Mr. J. L. Baird, and is now in practical operation. The apparatus designed for making use of the Cathode-rays is perhaps the most interesting, and while a system of television based on the application of Cathode-rays is most fascinating in its possibilities, up to the present time no practical success has been achieved by it, the difficulty of obtaining a sufficient response from the light-sensitive cell in this, as in other systems, preventing true television from being devised. Mr. Baird, using a purely mechanical exploring mechanism, succeeded some three years ago in publicly demonstrating the transmission of outline images by wireless between two separate machines, and subsequently, in January 1926, he demonstrated true television to members of the Royal Institution, real images with gradation of light and detail being transmitted. This was the first demonstration of true television ever given.

Outline of Principles Employed in Baird's System.

The principle followed by other inventors has been

adopted in this system, namely, that of rapidly traversing an image of the object or scene to be transmitted over a light-sensitive cell in a series of closely-drawn parallel paths. The picture reproduced is therefore one made up of fine parallel lines.

At the transmitting end, the light-sensitive cell used is the principal agent in effecting the transmission of the picture. The light proceeding from a brilliant source is reflected from the picture surface and focussed by means of the projection lens and through revolving discs on to the light-sensitive cell. The special type of light-sensitive cell used by Mr. Baird gives an instantaneous effect, and it is possible with such a cell to send a figure, a picture, or a series of moving pictures, like a scene made up of moving people, in rapid succession. The finely-drawn lines of light are swept across the picture by means of revolving discs having lenses, apertures, etc., which will be described in detail later on in this chapter. The varying gradations of light and shade of the picture, object, or scene alter the intensity of the rays reflected from it, which are focussed on to the light-sensitive cell, thereby causing electrical current variations to be given out by the cell which vary in strength in accordance with the light variations and are by this means transmitted to the receiving apparatus.

The variations in light intensity from the picture as they fall on the cell produce variations in electric current just as variations in speech uttered into a telephone transmitter produce variations in current along the line wire and actuate the diaphragm of the

receiver at the distant end. In the case of television, the varying currents set up by the light-sensitive cell are sent to that portion of the transmitting set which throws them into the ether. These currents on being received by the receiving set vary and control the light from a lamp placed behind an arrangement of revolving discs similar to that at the transmitting end. The

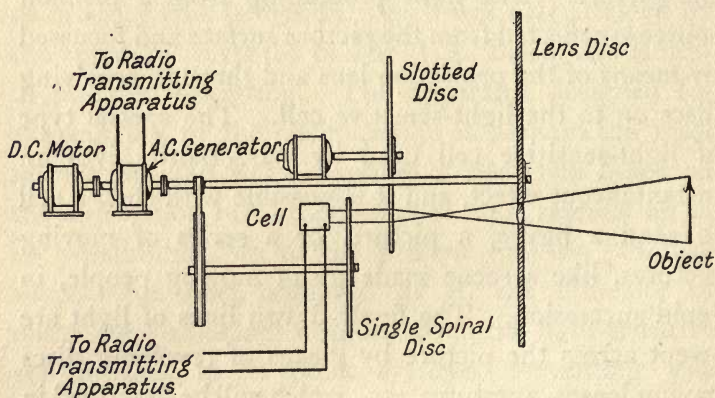


FIG. 79.—Diagrammatic Sketch of Transmitting Arrangements.

principle as applied in actual working at the transmitting end is shown in diagrammatic form in Fig. 79.

Original Apparatus—(a) Transmitting End.

The apparatus used in the first of these demonstrations is now in the South Kensington Science Museum, and consists at the transmitting end of a roughly constructed disc of cardboard containing 32 lenses in staggered formation (see Fig. 80) mounted on a shaft. Behind this and mounted on the same shaft are two additional discs, one with a large number of radial slots

(Fig. 81), and behind it another disc with a single spiral slot (Fig. 82). A sketch showing how these discs are mounted was given in Fig. 29, Chap. II.

The essential parts at the transmitting end are therefore :—

- (1) A revolving lens disc.
- (2) A revolving slotted disc.
- (3) A revolving disc with single spiral slot.
- (4) A light-sensitive cell.
- (5) Object or scene.
- (6) Source of light.
- (7) Radio transmitting set.

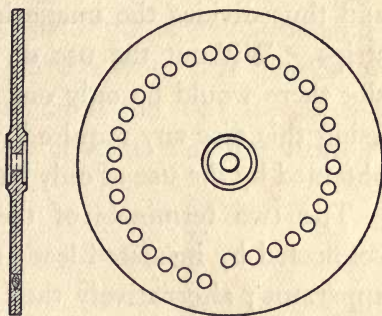


FIG. 80.—The Lens Disc (32 Lenses).

The revolving lens disc (Fig. 80), in front of which is placed the object, is the principal item of apparatus. This disc, which is provided with a single spiral of 32 convex lenses, is rotated at a high speed—800 revs. per minute, thus causing a series of images of the object or scene to pass across the aperture to the light-

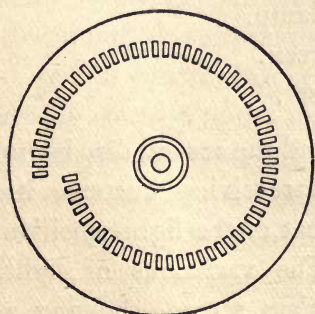


FIG. 81.—Disc with Radial Slots (64 Slots).

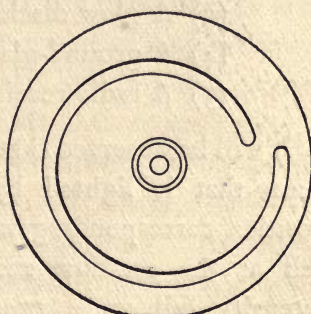


FIG. 82.—Disc with Spiral Slot.

sensitive cell. Before reaching this aperture the light is broken up by the slots in the second disc, which revolves at 1000 revs. per minute. The effect of the disc having the spiral slot is to give a backwards and forwards motion to the slot admitting light to the cell, and thus divides the image into a greater number of strips. Without the use of the disc with the spiral slot there would be only one strip for each lens. By using this disc any required number of strips may be obtained by the use of only a few lenses.

The two terminals of the photo-electric cell are connected by insulated leads to the radio transmitting apparatus; alternatively they can be connected to an ordinary twin pair telephone line.

(b) Receiving End.

The principal parts of the receiving end are almost identical, and Fig. 83 gives a diagrammatic sketch of this arrangement. They are :—

- (1) A revolving lens disc.
- (2) A revolving disc with spiral slot.
- (3) A glow discharge lamp.
- (4) A ground-glass screen.
- (5) A radio receiving set.

It will be observed that behind the second disc is the lamp that is lighted by the receiving current, its position corresponding with that of the light-sensitive cell at the sending end. The variations of light intensity fall on a ground-glass screen, showing a reproduced image of the object or scene transmitted.

There is no slotted disc at the receiving end; its presence is quite unnecessary.

To obtain synchronism, two motors are employed—a direct current motor which supplies the driving power and an alternating-current generator running at 500 cycles per second which sends out a synchronising signal. The alternating current from this generator and the fluctuating current from the cell are superimposed upon a carrier wave sent out and transmitted

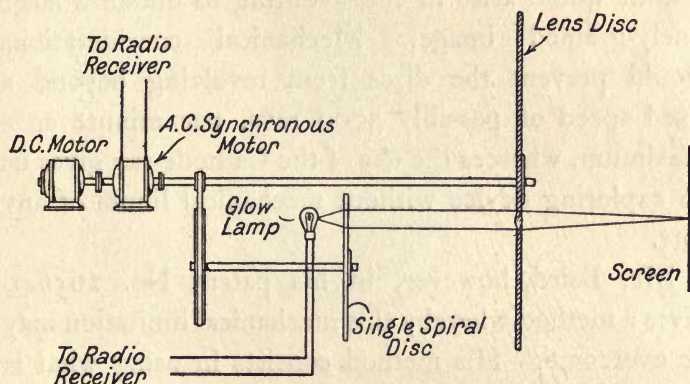


FIG. 83.—Diagrammatic Sketch of Receiving Apparatus.

to the receiver. At the receiver the two currents are filtered out, the alternating current after amplification is used to control the speed of a synchronous motor directly coupled to the shaft of the D.C. motor driving the receiving apparatus. Synchronism is obtained approximately by adjusting the D.C. motor, the A.C. motor being used to prevent hunting. At Mr. Baird's demonstration two separate transmitters and receivers were used for simplicity, one set for synchronising and one for Television.

The fluctuating current, after amplification, controls the light of the lamp, which is a glow discharge lamp of the Neon type (Fig. 84). The light from this lamp is caused by the rotation of the spirally slotted disc, and the lens disc, to traverse the screen exactly in step with the traversal of the image over the cell at the transmitter.

In criticising this original form of Mr. Baird's apparatus, the first point which appears obvious is that a limit would arise in endeavouring to obtain a large finely-grained image. Mechanical considerations would prevent the discs from revolving beyond a fixed speed of possibly 3000 revs. per minute as a maximum, whereas the use of the Cathode-ray gives us an exploring device without mechanical limits of any sort.

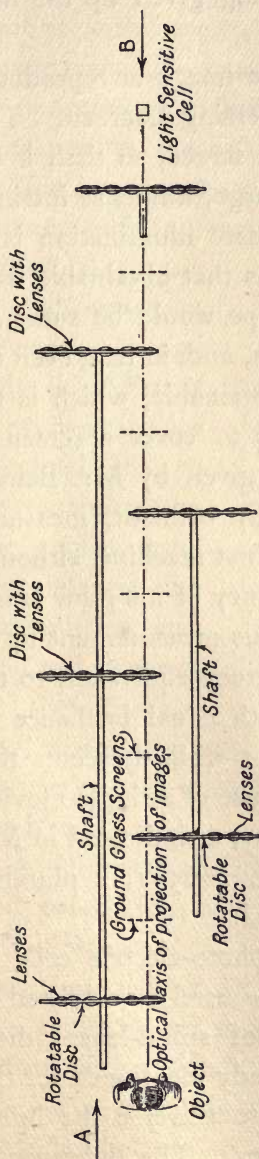
Mr. Baird, however, in his patent No. 265640 gives a method whereby this mechanical limitation may be overcome. His method consists in using what is described as an optical lever. He uses a succession of exploring devices, each device exploring the moving image of the one preceding it, so that the speed of traversal of the image is doubled with each operation without increasing the mechanical speed. It is an application to television of the principle of relative motion. Fig. 85 is a drawing reproduced from the specification which indicates one of the methods of applying this principle.

The two systems of lensed discs revolve in opposite directions, so that the motions they give to the image

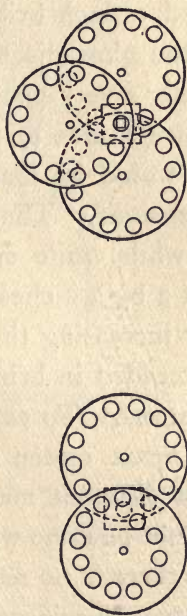


FIG. 84.—Neon Lamp.

[To face page 138.]



Plan of Apparatus



An End View looking in the Direction of Arrow B.

A Partial View looking in the Direction of Arrow A.

FIG. 85.—Baird's Optical Lever Principle.

are additive, lateral motion being given by the final lens disc.

A further point arises. The image is reproduced by a moving point of light traversing a screen. This point of light covers the whole screen, so that, if the point is small and the screen large, immense intrinsic brilliancy is necessary if adequate illumination is to be obtained. Such brilliancy as that obtainable from lamps of the glow discharge type would be sufficient to cover only a very small screen, and, in fact, even the most intense source of light obtainable, which is the arc lamp, would be inadequate to cover a screen of large dimensions. The image given by Mr. Baird's machine, while quite sufficiently brilliant, measured only about 2 by 3 inches in his first machine, although latterly by increasing the brilliancy of his glow lamps he has succeeded in bringing this measurement up to 8 by 12 inches. To cover a screen equivalent to the modern cinema screen and with equal brilliance is, however, a different matter, but while it seems that this could not be done with the use of a single moving light spot, there is no reason why, as indicated in Mr. Baird's patent specification No. 266591, a plurality of such points should not be used.

Accordingly, two or more photo-electric cells or other light-sensitive cells may be used as indicated in Fig. 86 with the arrangement of spiral-lensed disc, slotted disc, and other parts already mentioned for the purpose of causing the image to traverse the light-sensitive cell in a series of strips. The light waves from the view or scene by this means impinge inter-

mittently on the separate light-sensitive cells, each cell dealing with its own wave-band of the view scene, or image transmitted and controlling its own light source. It is necessary to have a different frequency of intermittence for the light waves incident on each of the cells, so that each cell sets up a current having a frequency differing from that of any of the other cells joined in circuit as light-sensitive devices. The signals of different frequencies so obtained are to be transmitted on the carrier wave sent out by the transmitting station and received at the distance

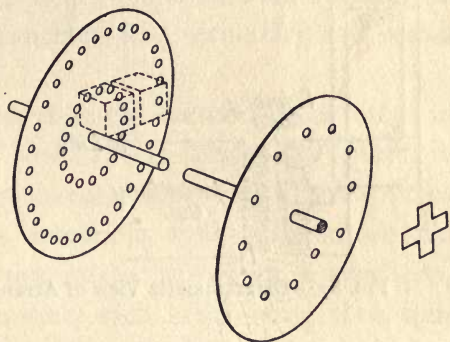


FIG. 86.—Arrangement with two or more Photo-electric Cells.

end, where they are separated out by means of filter circuits or sent on separate wave lengths and reproduce the image.

A diagrammatic view of the arrangement of parts and connections is shown in Fig. 87 and should be self-explanatory, as the descriptions of the various parts have been added on the drawing. The lensed disc has 12 lenses set in spiral contour and is mounted on a shaft with which it is rotatable. The double slotted disc is a rotatable disc having two sets of radially arranged holes or slots, the number of holes in the outer set being double the number of those in the inner set.

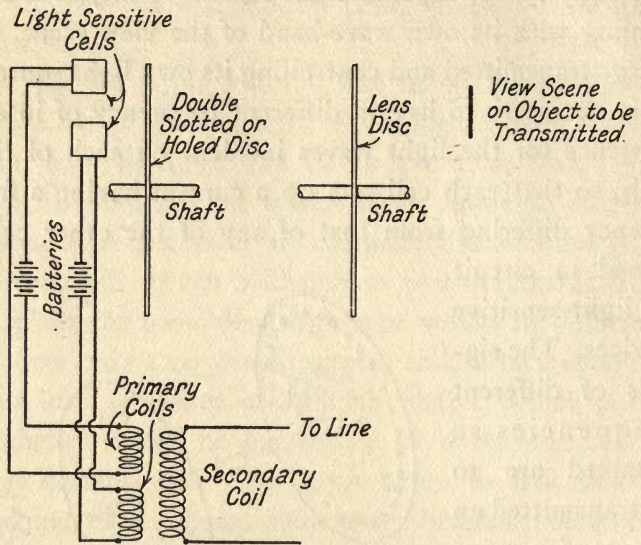


FIG. 87.—Diagrammatic View of Arrangement in Fig. 86.

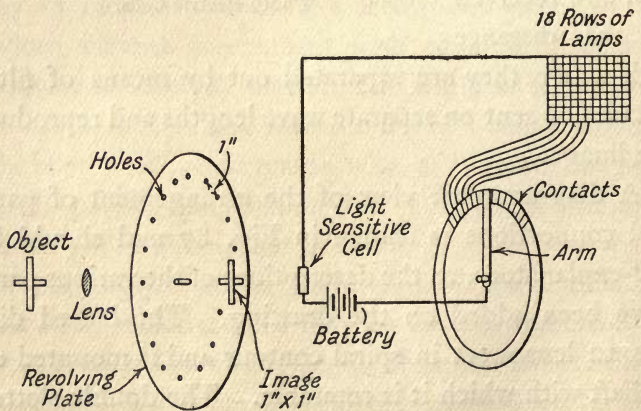


FIG. 88.—Baird's Method of employing Plurality of Light Sources.

This latter disc revolves at a speed so that 1000 interruptions (or more) per second of the light waves from the inner set of holes are given. The outer set of holes may be arranged to give, say, 2000 or more interruptions per second of the light waves. The light-sensitive cells are connected to ordinary H.T. batteries and to a transformer as shown. Each light-cell, however, has a primary coil of its own, but the two primary coils are connected to a secondary coil which is common to both.

Another altogether different method is indicated in Mr. Baird's Patent No. 222604 (Fig. 88). Here, in place of a single light source, a plurality of light sources disposed to form a screen is used. These are fed in succession by a commutator revolving in synchronism with the transmitter, each lamp being thus connected in turn with the transmitter, so that a moving light spot traverses the screen. With this system there is no limit to the size of the screen nor to its brilliancy, but the complexity of the apparatus involved would appear a considerable barrier to its practical use.

As in previous types of similar apparatus, a light-sensitive cell is placed behind an exploring disc at the transmitter and the variations of light falling on it cause the current set up in the cell to vary. A valve amplifier strengthens this varying current so that it can be transmitted, when connected to a wireless transmitter set, to the receiving station.

At the receiving end a brush arrangement fitted at the end of an arm (see Fig. 88) revolves in exact

synchronism with the transmitting disc already referred to. As this brush revolves it passes over a series of contacts marked in the drawing, each of which is connected to a small electric glow lamp. There is an indefinite number of these lamps; the more lamps there are the more perfect in detail will be the reproduced image, since these lamps constitute the screen on which the picture can be viewed.

Each hole in the transmitting disc as it revolves sweeps out a strip of the image, and the arm, which revolves in exact synchronism with the disc, sweeps over the contacts connected with the first row of lamps, thus lighting each lamp in turn as it touches the corresponding contact. Each hole in the disc has therefore its corresponding row of lamps. If at the moment a bright part of the image is traversed by the light that passes through a hole, the appropriate lamp is lit brightly; if, on the other hand, light from a dim part of the image passes through a hole, the corresponding lamp will be dull.

A disc of 18 holes should have 18 rows of such lamps, and each row may have any number of lamps in it, as already mentioned, to give better definition. Since there must be a contact for each lamp, 18 rows of 20 lamps in each row would require 360 contacts.

From what has already been said on the general theory of working television apparatus, it will be evident that the varying brightness of the numerous lamps that form the screen will reproduce the image,

and that visual persistence will blend the rapid successive variations into one whole image.

Another interesting patent which is worthy of description indicates the method of obtaining intense illumination of the object to be transmitted without the

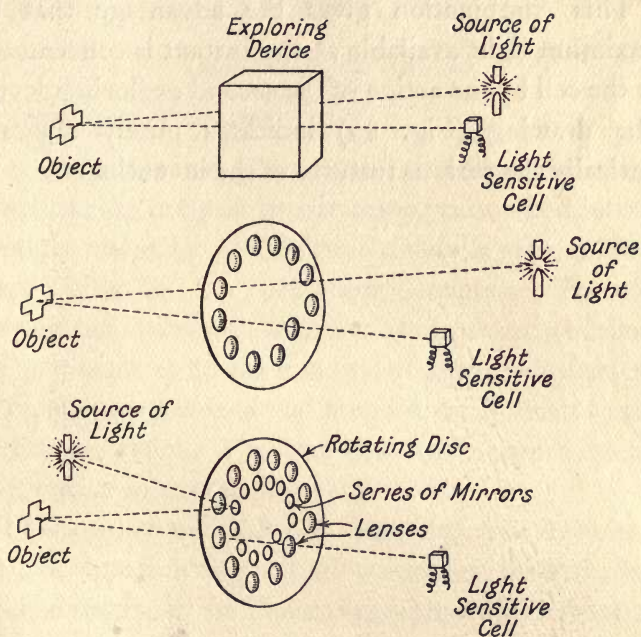


FIG. 89.—Baird's system of Exploring the Object to be Transmitted by a Single Point of Intense Light,

disadvantage of brilliant flood lighting. The system is described in Mr. Baird's Patent No. 269658 and consists of exploring the object to be transmitted by a single point of intense light. This pencil of light is caused to traverse the object and is used in conjunction with a stationary photo-electric cell. As the point of light is continually moving, it may be made very

intense without inconvenience to the sitter. The patent describes methods of using a moving light spot alone, and also in conjunction with a device causing the image to traverse the cell simultaneously with the traversal of the light spot over the object.

This combination gives the advantage that the maximum light available at any instant is concentrated on the cell by the action of the second exploring device. The drawing (Fig. 89) indicates purely diagrammatically the various features of the invention.

CHAPTER IX

TELEVISION TECHNIQUE

Present State of the Art.

REVOLUTIONARY advances in technique have been made during the past two or three years, notably those brought about by Mr. Baird, the details of which were dealt with in the preceding chapter. Therefore leaving the development of the art as already outlined, we now come to an examination of present-day practice of reproducing scenes that are ordinarily out of range of human vision, a matter that will acquire greater importance in succeeding years.

Present-day methods of achieving true television, that is, transmitting actual scenes as distinct from cinematelegraphy or phototelegraphy, differ from the devices that made Korn's and Belin's early successes in phototelegraphy epoch-marking events in the past. Their crude but encouraging results were only achieved in those pioneering days of the art by relying on a line or metallic conductor to carry the transmission over two different points, and when at a later stage transmission without wires was essayed, the employment of syntonic wireless with carborundum detector (Fig. 90) was the only available means of bridging space. To-day more ingenious devices and apparatus and improved methods

of transmission can be incorporated into the electrical circuit arrangements, and the operation of transmitting sight without the aid of any material link whatever may be quite accurately described as “wireless seeing,” in just the same way that speech across countries, oceans, and continents may be termed “wireless telephoning.”

Modern Requisites and Procedure.

It will be obvious from the few details already given of how various investigators have endeavoured to

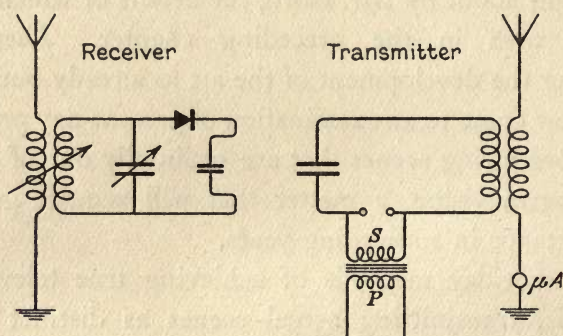


FIG. 90.—Syntonic Wireless Circuit with Carborundum Detector.

design apparatus for seeing by wireless that certain requisites are necessary and that certain well-defined principles must be followed. These may be briefly summarised as follows:—

(1) A source of light is necessary to illuminate the scene, object, or objects to be transmitted. This must be, so far as experiment has taught us, a strong and brilliant illuminant, because it can be used only after reflection and consequent attenuation.

(2) It is necessary to focus the object or scene so as to form an image. Some means must be adopted, such as a system of lenses or mirrors for image formation, both at the transmitting and receiving ends.

(3) This image, by means of a device at the transmitting end, must be split up into strips which are received synchronously in a similar fashion and by a similar device at the receiving end and rapidly thrown on a screen. The only way in which the whole image can be rendered visible in the ordinary way is to show it on the screen at the same rate and in the same manner as pictures are shown at the cinema, namely, about sixteen whole pictures in succession every second, the picture thus appearing as a continuous one, due to visual persistence.

(4) During this process the image with its variations or graduations of light and shade must be cast on to a device that will convert the graduation of light and shade into variations of electric current at the transmitting end. This is the electric "eye." The various forms of light-sensitive cell that are used as electric eyes have already been fully described, the photo-electric cell at present holding and will continue to hold the field until outclassed by a better device.

(5) Feeble currents only can be expected to be set up by this means, since no material substance is known that will give out currents strong enough for the purpose required and hence a magnification or an amplifier of the current impulses is necessary. The best known amplifiers of current are the ordinary valve amplifiers.

(6) An illuminant—a glow discharge lamp—is necessary at the receiving end which has its intensity of illumination controlled by the varying received current. The image thus formed has therefore variations of light and shade similar to the transmitted image when it is thrown on to a receiving screen.

Illuminants.

The difficulty of providing a suitable source of light for use with either a selenium cell or any form of photo-electric cell has always been one not easily overcome. The source of illumination must be one of steady and uniform intensity, but withal of sufficient power and brilliance, so that the light reflected from the object may be of maximum intensity.

Originally Mr. Baird used a metal filament projection lamp of 1000 candle-power with his apparatus. This was quite suitable for inanimate objects, but much too bright to be comfortable for a human face, in fact even a 500 candle-power lamp at a short distance has a most unpleasant effect upon the eyes. A bank of 20 ordinary 40 watt lamps at about 2 feet from the sitter was subsequently adopted. The brilliance of these lamps was controlled by a resistance so as to give ample illumination without distressing the person whose image was being transmitted. Fig. 91 shows the bank of lamps employed by Mr. Baird.

Synchronism.

A simple method of effecting the synchronism of the transmitting and receiving apparatus is that adopted

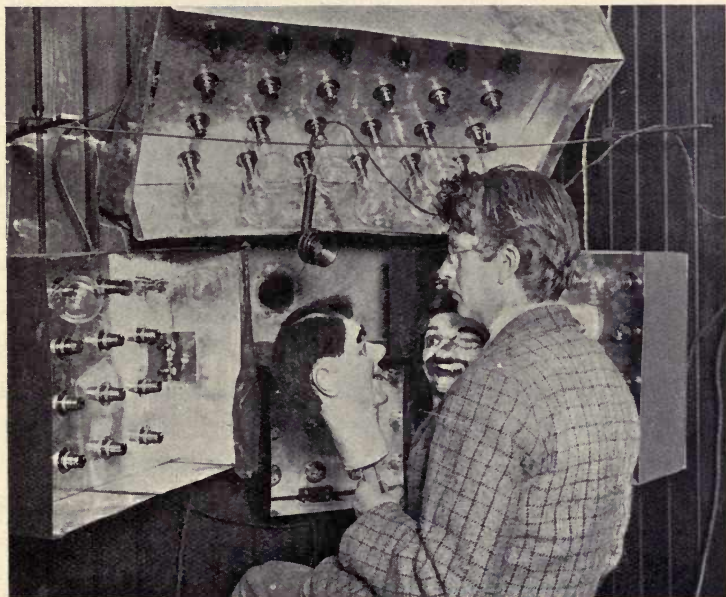


FIG. 91.—Bank of Lamps.

To face page 150.

in the Baird system of television. At the transmitting end the apparatus, that is to say, the rotating discs for focussing and subdividing the image, are driven by a shaft connected to two motors, one a D.C. motor which supplies the driving power to the shaft, and the other an A.C. generator having a frequency of 500 cycles per second which sends out a synchronising signal. The alternating current from this generator and the fluctuating current from the light-sensitive cell are sent on separate wave-lengths or superimposed on a carrier wave and sent out to the receiving end, where the two currents are filtered out. Like the carrier wave in radio telephony transmission, this carrier wave is modulated or moulded to conform to the frequencies imposed on it. The alternating current after amplification is used to control the speed of an A.C. synchronous motor directly coupled to the shaft of the D.C. motor driving the receiving apparatus. Synchronism is obtained approximately by adjusting the D.C. motor, the A.C. motor being used to prevent hunting. By this means isochronism is obtained. To obtain synchronism, the motor of the receiving machine is rotated about its spindle until the received picture is correctly framed.

A modification of this device was used by the American Telephone and Telegraph Company in the recent experiments in America. Instead of using a D.C. motor to give the drive, a low frequency A.C. motor was used, which has the advantage of making the initial process of getting the two machines in step simpler. It has, however, the very serious disadvantage

of requiring another synchronising line or wave-length. To obtain synchronism, the American Telephone and Telegraph Company use the system described by Mr. Baird of rotating the driving motor about its spindle.

Television Radio Equipment.

The equipment of an ordinary short-distance television wireless circuit so far described has been chiefly that comprising the purely mechanical parts and their operation. It may be of interest therefore to outline very briefly the electrical equipment and circuit connections.

As with the transmission of music and speech without the aid of wires, so with the transmission of sight, the careful balancing of an aerial circuit by means of suitable inductance and capacity is an essential. We have the same conditions to observe and consequently the same wireless apparatus parts to join in circuit.

As already mentioned, when initial efforts at transmission were made experimenters were very much handicapped because syntonic wireless with carborundum detector was the only known means of bridging space without a wire conductor. To-day we have in conjunction with continuous wave transmission, the thermionic valve, which is a great advance in the method of effecting communication without wires between any two points. Again, a quarter of a century ago, the development of television was hindered for the want of suitable energising apparatus, but there is no need for it to languish on that account to-day, since

the thermionic valve can be utilised both for controlling and amplifying television currents in the various sections of the path between one observer and another. Further, the use of transformers and those individual combinations of inductance and capacity known as filters for selecting and rejecting undesired frequencies are now found to be a very important means towards perfecting results.

Short Wave Wireless Television.

When it became evident that radio television was an accomplished fact, it followed that the next stage was to design and instal equipment necessary to ensure successful commercial operation. General experience in radio transmission points to the fact that fading of signals and the occurrence of atmospherics were the difficulties to be encountered in transmitting vision over considerable distances. The preliminary data already on hand showed what minimum amount of power was necessary for particular or given transmission, the necessary receiving arrangements and connections and the best wave-length on which to work being determined by trial and experiment based on current radio practice.

The extremely rapid manner in which short wave stations have sprung up in recent years, hundreds of transmitting stations working on wave-lengths between 150 m. and 15 m. having been set up by both commercial companies and Government administrations all over the world, decided the Baird Television Development Company in experimenting with syste-

matic long-distance trials on the short wave for television purposes. One important advantage of the short wave is that a comparatively small expenditure of time and money is required to set up, for example, a 2 kw. 50 m. transmitting set complete with a small effective aerial 30 or 40 feet high for a range covering thousands of miles.

Within the last three or four years it has been discovered that waves below 100 m. (approximately) display phenomena which are not met with in long waves. The latter travel in the form of a direct or earth-bound wave and over a great distance may be attenuated by absorption to an almost negligible intensity. On the other hand, short waves are absorbed but very little in the upper regions of the atmosphere, although they may be in the ground.

The technique of producing and detecting short waves is admittedly difficult, but, beyond that there is, in addition, the drawback of their remarkable inconsistency. Hence, scenes televised in daylight quite successfully on a certain wave-length may be a complete failure in the dark at night, and even when sent over different tracks success may be confined to one track and not to the others.

The Special Aerials.

Having decided that short-wave working would prove on the whole more efficient and satisfactory for television transmission than the employment of long waves, the next step was to devise a special form of aerial suitable for the purpose. Since the power may

more or less be concentrated in the one *direction in which it can be utilised*, beam radiation, as practised by Hertz years ago, has been tried in many instances by exciting a plurality of spaced aerials—but, generally

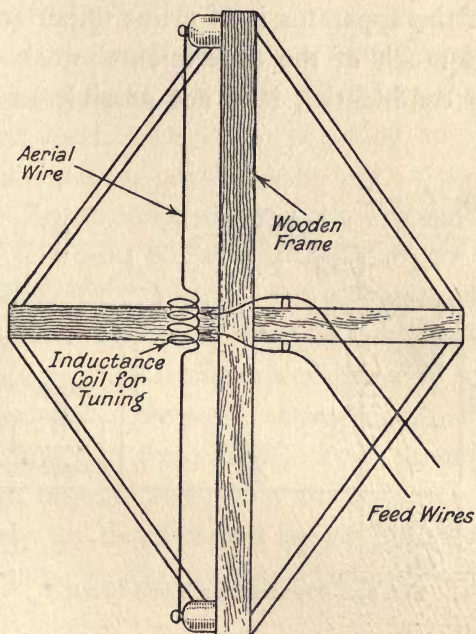


FIG. 92.—Short Wave Transmitting Aerial.

speaking, a single vertical aerial without mirror or other similar device and of the type shown in Fig. 92 has been found sufficient to cause radiation most strongly in a direction inclined to the horizontal when it is excited with an appropriate harmonic of its fundamental frequency.

The Transmitting and Receiving Circuits.

In conjunction with the design of special aerials, the question of design of circuits for the transmitting and receiving sets connected to the purely mechanical portion of the apparatus is of prime importance. As at present much of the experimental work must be treated as confidential, it is not possible to give the

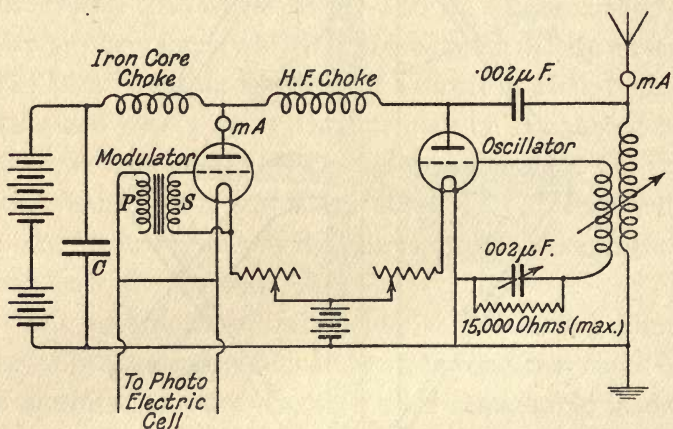


FIG. 93.—Transmitting Radio-circuit.

diagrams of the actual circuits now in use, but Fig. 93 gives a suitable circuit for working on the 200 metre wave-length that is normally employed in television. Here again, acting on the ideas inspired by wireless practice in cognate fields, the general type of circuit having what is known as choke control has been adopted.

The reduction of the wave-length to 40 metres has been effected in certain instances, and it is found that for transmitting images over very short distances good

results have been obtained by employing a circuit with grid control.

The receiving circuit may be any one of the well-known types of short-wave receiving circuit.

Transatlantic Television.

Although the public mind is no doubt surfeited with successive wonders in scientific discovery, there is little doubt that another has yet to be added, in that seeing across the ocean and continents is only a matter of time.

Assuming a London–New York Television Circuit possible, it should be remembered that, so far as our present knowledge extends, the conditions governing the use of such a circuit worked on a short wave-length would be very different from a circuit over which long waves are sent. The signal strength on a short wave-length would vary from hour to hour, sometimes from minute to minute, and while atmospherics would be not nearly so troublesome as on long-wave transmission, they would constitute a factor to be taken into account.

Experiments are being conducted at the present time with a view to establish a television circuit across the Atlantic, and probably results of a sensational character will be available for publication shortly. While adopting an attitude of reserve concerning the success of such an endeavour, it should be remembered that not many years ago Marconi in his first efforts at ocean telegraphy merely obtained a series of three dots. To-day messages can be sent and received quite satisfactorily between Europe and America. In like

manner, seeing across the ocean may become an established fact.

Its Possibilities.

At the time of writing, there are several television stations in the country all working on the system invented by Mr. Baird. The stations between which operations are carried out by the Baird Television Development Company, Ltd., their distances apart, official call signs and wave-lengths, and opportunities for receiving scenes by means of Televisors will form the subject of a public announcement very shortly.

Now there is no reason from a technical standpoint why these distances should not be greatly increased. Instead of the old tools being relied on, new ones in the shape of oscillographs, radio valves, the thermionic tube, the photo-electric cell, as well as many other ingenious mechanical contrivances, not to mention the short wave beam system of transmission, are available.

Television over distances of small range is quite an accomplished fact and it only remains to perfect the details of the scenes transmitted. Since, moreover, television is worked on the same principle as radio telegraphy and radio telephony, there is no reason why seeing events that are happening in America cannot be just as easy of accomplishment as ocean talk to America. The same theoretical and mathematical considerations are applicable. Hence the aim at the present time is to extend the range of transmission.

In this respect the utilisation of the short wave or

beam system is found to be very much better as a working and commercial proposition than the adoption of long waves. Primarily short wave transmission has two advantages, (1) its directional character and (2) the comparatively small transmitting power required to ensure successful results. The theoretical considerations respecting wireless equipment and the use of short waves for television circuits, however, it is intended to discuss more fully at some future time in another book, when television practice has become more advanced.

CHAPTER X

RECENT DEVELOPMENTS; VISION IN DARKNESS; THE NOCTOVISOR; THE PHONOVISOR; LONG DISTANCE TRANSMISSION

ONE of the most remarkable developments of television has been achieved by Mr. Baird's successful application of the infra-red ray to his televisor.

The observed facts as revealed by experiments which have taken place during the last hundred years show us that waves of varying length are transmitted through the ether. These waves vary in length from thousands of metres down to lengths so small that even present-day apparatus cannot measure them. In recent years, the longer waves have been made quite familiar to us on account of their use in wireless transmission of sound and speech. The waves that measure only a fraction of a millimetre, however, are known to us only as light waves. They vary in length between the limits of 0.00076 mm. and 0.00039 mm. Ordinary white light manifests itself to us when the whole group of the waves between these limits affect the optic nerve. If, however, we look at the same light through an atmosphere of fog it appears red, due to the shorter waves being absorbed and the longer waves only—those near the 0.00076 mm. limit—being able to penetrate the fog and affect our eyes.

Red rays are relatively long when compared with violet rays, but assuming a hair to be $\frac{1}{1000}$ th of an inch thick, its diameter is still nearly forty times greater than the length of a wave of red light.

Invisible Rays.

Scheele, the discoverer of oxygen, was the first to give a lead towards the discovery of other rays than those which produce ordinary white light. Acting on the knowledge that white light could be split up into the primary colours—red, orange, yellow, green, blue, indigo, violet (the spectrum)—by means of a prism and also that sunlight changed the colour of silver chloride from white to purple, he sought by experiment to find out which of these seven colours of sunlight produced the maximum effect. He found that the maximum effect was obtained when the silver chloride was exposed to the rays at the extreme violet end of the spectrum.

This was a step forward. Herschel was the next to throw further light on the subject while investigating the heating properties of the visible rays produced by the sun in order to ascertain which of them (the red, yellow, blue, green, or violet) had the least heating power. He split up the white light from the sun into the coloured spectrum produced by a prism and then tested each colour by allowing it to fall on the bulb of a very delicate thermometer. By trial and experiment in this manner he found that he could get a maximum heating effect when the thermometer was in a position beyond the red, namely, in the path of

an invisible ray. He pursued his experiments further and established beyond any doubt that the sun gives out invisible rays whose wave-lengths are greater than the longest red rays (0.00076 mm.). These rays are known as infra-red rays (Fig. 94).

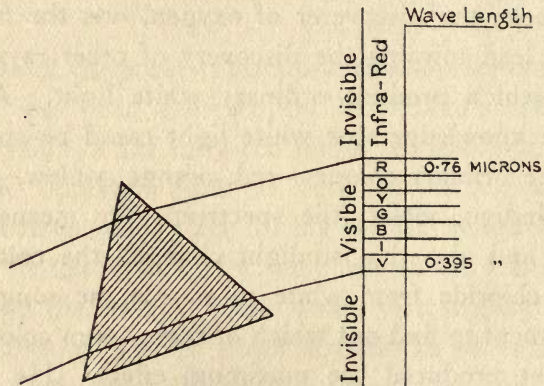


FIG. 94.—The visible Colours produced by a Prism—a part of the great Electro-magnetic Spectrum.

Properties of Infra-red Rays.

The infra-red rays make themselves apparent by the heat they produce. If they are allowed to fall on very fine wire, the wire increases in temperature sufficiently to observe a change in its resistance. This change of value in the electrical resistance of a body is very noticeable in their effect on a Selenium cell. If a beam of infra-red rays be allowed to fall on a Selenium cell then the resistance of the cell is altered during the time the rays fall on it. Such a cell, therefore, can be used as a detector of infra-red rays.

Use of the infra-red rays to affect a Selenium cell

for practical signalling purposes was made by Ruhmer over twenty-five years ago, who gave a demonstration before the Electrical Society of Berlin on March 19th, 1902.

If a thin sheet of ebonite or bakelite be placed in the path of the sun's rays, the infra-red rays will pass through with very little diminution in intensity, although the visible rays are completely absorbed.

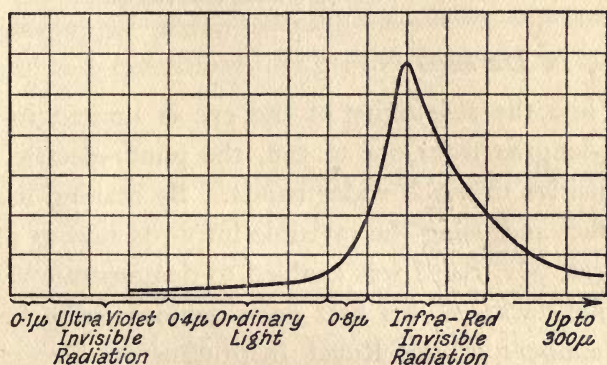


FIG. 95.—Radiation Energy Curve for the Spectrum.

This fact was noted by Ernest Ruhmer over twenty years ago.

The photo-electric cell is sensitive to rays of the spectrum beyond the range of vision both in region of the ultra-violet and of the infra-red. Such cells as the potassium cell possess their greatest sensitivity in the ultra-violet region, others, like the rubidium cell, have their greatest sensitivity in the yellow band, but these cells as a class are the least sensitive to the infra-red (Fig. 95). The following figures taken from Thompson's "Discharge of Electricity through Gases"

give a good indication of the characteristics of the usual types of photo-electric cells :—

Type of Cell.	SENSITIVITY.			
	Blue.	Yellow.	Orange.	Red.
Rubidium .	0·16	0·64	0·33	0·039
Potassium .	0·57	0·07	0·04	0·002
Sodium .	0·37	0·36	0·14	0·009

Sensitivity to white light being taken as unity.

Vision in Darkness.

While the sensitivity of the eye is limited to the wave-lengths from 0·4 to 0·8, the photo-electric cell is sensitive to much wider bands. By making use of this fact and using the invisible infra-red rays in place of light, Mr. Baird was enabled to demonstrate vision in total darkness, his first open demonstration being to members of the Royal Institution on December 31st, 1926.

It would seem at first surprising that these rays should have proved successful rather than the ultra-violet rays, which have a much superior photo-electric effect. The ultra-violet rays, however, have a very small penetrative power. Ordinary glass offers a resistance to them and they are dispersed by the atmosphere much more rapidly than visible light is dispersed. They also have a dangerous action on the eyes and skin, and these reasons probably led Mr. Baird to choose the infra-red rays in preference to the ultra-violet. As already stated, the presence of these infra-red rays was first detected by Sir William Her-

schel when investigating the spectrum by means of a thermometer. He found that the great heating effect took place at a region beyond the red end of the spectrum and that these rays also affect photo-electric cells, although to a much less extent than the rays of the visible spectrum.

While they are quite invisible to the eye, they are otherwise identical in their properties to light. They can be reflected and refracted and can also affect a photographic plate, although the effect is extremely slight and exceedingly long exposures are necessary.

The Noctovisor.

One of the most surprising developments of television is unquestionably the recent demonstration of Vision in total Darkness. In these demonstrations, which were given by Mr. Baird in December, persons sitting in total darkness were seen and recognised by observers on the screen of a modified form of television apparatus which Mr. Baird has termed a "Noctovisor."

This remarkable result is achieved by using in place of light the invisible rays beyond the red end of the spectrum. Photographs were taken many years ago in the early days of photography by means of these rays by Abney and others. The rays have also been used for signalling as they affect Selenium cells and also, although in a much lesser degree, photo-electric cells. It remained, however, for Mr. Baird successfully to apply them to television and thus render actual direct vision in darkness possible.

Mr. Baird's "Noctovisor" (Fig. 96), as he terms

it, consists essentially of a Television Transmitter and Receiver directly coupled together. The eye of the Television Transmitter scans the scene which, although in total darkness as far as the human eye is concerned, is flooded with infra-red rays. These rays affect the cell in precisely the same fashion as light rays, so that an image appears upon the screen of the directly-coupled Receiver.

The nature of the image thus received is somewhat distorted, red appearing as white and blue appearing as black, a further peculiar effect is that smoke and vapour are semi-transparent, so that the device to some extent renders vision through fog possible.

The fog-penetrative powers of the infra-red rays are, of course, no new discovery, it being well known that the penetrative power of light varies as the fourth power of its wave-length, red light penetrating fog some sixteen times better than blue light.

Advantage of this phenomenon is now being taken in aerodromes, where neon tubes with their deep red glow are used to guide the airmen, on account of the fog-penetrating powers of these red rays.

A short-range demonstration of the fog-penetrating powers of these rays was given by Mr. Baird on the screen of his "Noctovisor" recently, a dummy's head in a room filled with a fog perfectly opaque to ordinary vision being clearly seen on the receiving screen. This demonstration, however, showed only the penetrative power over a short distance, and it will be interesting to see if the effect is available under the conditions which prevail, say, in a sea fog, where the

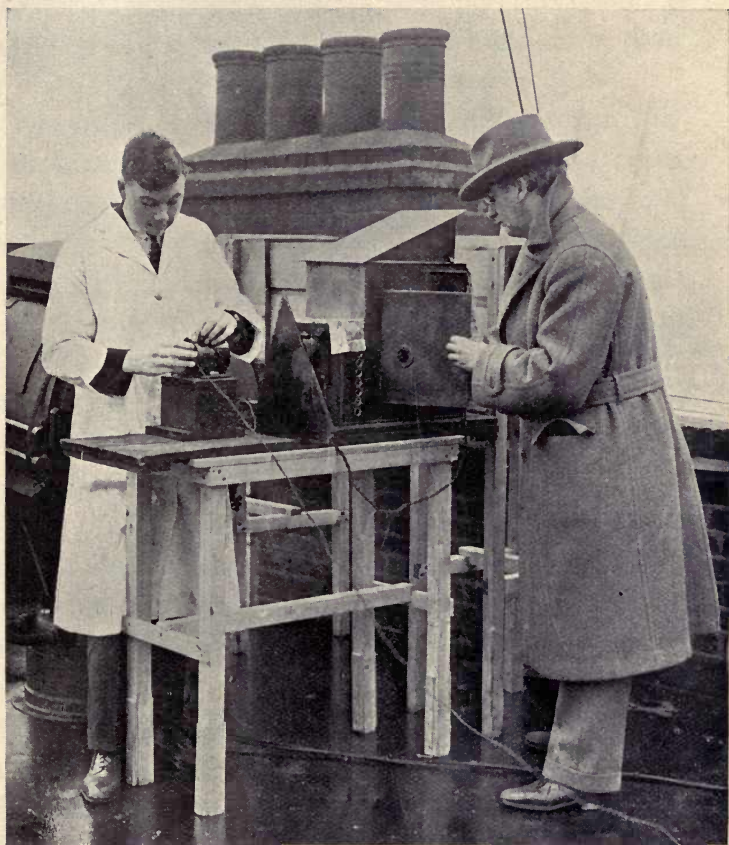
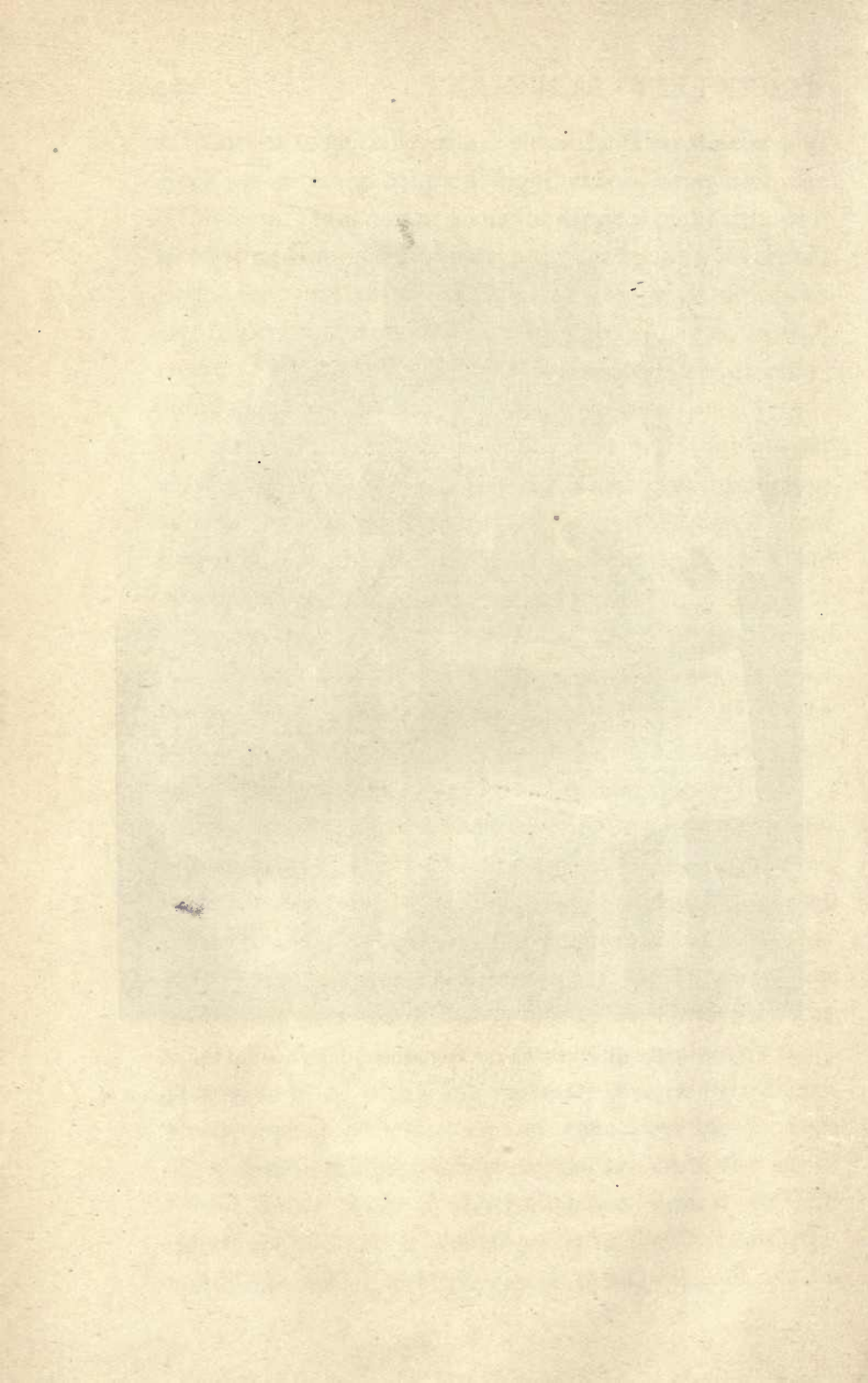


FIG. 96.—Mr. Baird testing the Fog-penetrating Power of his
"Noctovisor."

[To face page 166.]



penetration to be commercially effective must have a range of miles rather than yards.

Advantage has been taken of these rays for signalling purposes during war time, the rays being used in place of visible light to actuate photo-electric relays.

Mr. Baird by successfully using these rays in conjunction with a coupled television receiver and transmitter has rendered actual vision possible in total darkness. The appearance of coloured objects when received by the infra-red rays differ considerably from their appearance under normal illumination, due to red colouring appearing as vivid white, and the use of these rays is much more difficult than the use of normal illumination, so that there is no advantage in their use for television as such.

The ability, however, to see without the use of light has obvious uses in warfare, and a further possible application for the "Noctovisor" is disclosed by the fog-penetrative qualities of the rays used. Since these rays penetrate some sixteen times farther through fog than does visible light, it is reasonable to expect that this may open up a field of utility for the "Noctovisor" in increasing the range of vision through fog. Any increase of visibility in foggy weather would be of immediate advantage to the mariner and the aviator.

The "Phonovisor."

In transmitting the image of any object by television, the traversal of the image over the cell causes the production of a fluctuating electric current, the character of the fluctuations being determined by the shape and

appearance of the object or scene being transmitted. If the fluctuating electric current is received on a telephone in place of a televisor, a noise is heard, this noise having a different character for every object, so that every scene may be said to have its corresponding "image sound." By listening intently it is quite possible to distinguish two different human faces by their equivalent sounds, and the difference between a hand and a face is very marked. Every movement is audible, opening the mouth, for example, causes an immediate change in the note.

By recording these sounds on a phonograph, a permanent record can be taken, and if these records are played again into a microphone connected to a televisor working in synchronism with the phonograph the original image is reproduced, thus turning a scene into a fluctuating electrical current, then into a sound, then indentations on wax, then reversing the whole series of processes and recovering the scene from the wax disc, so that we have a means of storing living images upon phonograph records. Mr. Baird has given the name of "Phonovisor" to this device, which has interesting possibilities.

It is perhaps not too wild a flight of fancy to say that by a development of the "Phonovisor" the blind may one day learn to know their friends by the sound of their faces. Whether this method will in any way displace the cinematograph is doubtful, but it certainly is a noteworthy scientific achievement and had the cinematograph not already been in existence would have been of the first importance.

Long Distance Television.

In April 1927 television was demonstrated in the U.S.A. by the American Telephone and Telegraph Company. Their system consisted in exploring the scene at the transmitter by means of a point of very intense light, and by this means obtaining an illumination of immense brilliance without dazzling the person being transmitted. The arrangement used consisted of a disc with a spiral of holes revolving in front of a power arc lamp as shown in Fig. 97. By this means a spot of light from the arc was caused to traverse the face of the person being transmitted. The light reflected back from the face was caught by three large photo-electric cells, and the fluctuating current from these cells transmitted after amplification to the receiving station. By means of a commutator it was fed to a bank of small neon lamps, arranged in the form of a screen, each lamp being fed in succession so that a spot of light in effect traversed the screen.

A small machine was also shown with a single neon tube behind a disc with holes in spiral formation.

Synchronism was obtained by means of synchronous motors, separate synchronising signals being transmitted between receiver and transmitter. A large low frequency synchronous motor being used to obtain approximate synchronism and a small high frequency synchronous motor used to prevent hunting.

While the question of distance is not of primary importance, considerable distances have now been spanned. The American Telephone and Telegraph

Company have transmitted between New York and Washington, a distance of 200 miles, and Baird in this country has transmitted between London and Glasgow, a distance of 400 miles. In both cases, telephone lines were used, and it is remarkable that successful results were achieved in spite of the capacity effects inseparable from long-distance lines.

The apparatus used appears to have been comparatively simple in the London to Glasgow demonstration, as a total of three operators only were required, the receiving instrument being contained in a box which as shown in the photograph (Fig. 97) is little bigger than a large suit-case.

The American Telephone and Telegraph Company employed a great number of operators in their demonstrations, nearly 1000 men having been engaged in the New York to Washington demonstration. Their apparatus involved no fewer than four separate channels, two for synchronising, one for the television impulses, and one for speech, whereas Baird used two only, one for television and one for speech.

At the time of writing television sets are not available to the public, but their advent cannot be long delayed. The first sets will, we may anticipate, show only the most simple of scenes, a head-and-shoulders view of the person speaking, or possibly a simple scene, such as a few figures on a stage with little detail; but with the rapid development of wireless broadcasting in view we may reasonably expect that the development of television will continue steadily until results rival the perfection of the present-day cinema, and with the



FIG. 97.—Television between London and Glasgow. Professor Taylor Jones in Glasgow sees and speaks to Mr. Baird in London.

{To face page 170.

perfection of television, allied arts, such as Noctovision, will develop along parallel lines, so that perhaps we may conclude by quoting Professor Ayrton's remarkable prophecy when, in 1880, he stated: "The day will come when we are all dead and forgotten and our electric cables have all rotted away. In these days a man who wishes to speak to a friend will call him with a world-embracing electric voice and his friend will reply, perhaps from the slopes of the Andes, perhaps from a ship in the midst of the ocean, or if there is no reply, he will know that his friend is dead." Ayrton's world-encompassing electric voice is with us now, within less than fifty years of the utterance of what must have seemed at that time a wild flight of fancy.

Television will give to us electrical vision and an annihilation of space which far exceeds Ayrton's prophecy.

APPENDIX

A London-New York Television Circuit.

AT the time of going to press Transatlantic Television, which was referred to in Chap. IX as being in the experimental stage, has become an accomplished fact.

In the early morning of February 9th a demonstration was given in Hartsdale, a suburb of New York, to the Press, when faces in London were seen on the screen of a small Television receiver in New York. The first face transmitted was that of Mr. Baird, and this was followed by the face of a Press representative (Mr. Fox), and later by the face of a lady (Mrs. Howe). The faces of Mr. Baird and the Press representative were recognised; the face of the lady was, however, indistinct, the features not being clear.

The transmission took place on 45 metres from a 2-kilowatt station situated at Purley, fifteen miles out of London, the Television transmitter being at the head-quarters of Mr. Baird's Company in Long Acre, London. The Television impulses were transmitted over telephone wires to Purley, and after amplification at Purley were used to modulate the carrier wave of the 45-metre transmitter. Reception at Hartsdale took place on a one-valve receiver using reaction. The received signals were subsequently amplified by a four-valve low-frequency amplifier, and then used to control the light of the glow discharge lamp in the receiving Telesvisor.

Communication between Hartsdale and London was carried out by Morse signals from a small wireless transmitter working on 37 metres from Hartsdale.

The picture received was 2'' by 3'' in size, the over-all dimensions of the receiving apparatus being 2' by 3' by 8''. In the experiment only one operator was required to operate a receiver of the simplest possible form, and it is probably owing to the simplicity of the apparatus that success was possible.

Experiments are being continued in the Company's laboratories in Long Acre, and apparatus is in use experimentally which produces a life-size picture. A larger power wireless transmitter is also in course of erection, and with increased power and perfected apparatus much better results are anticipated.

Owing to the achievement of this Transatlantic Television the distances mentioned on p. 169 have naturally been considerably increased.

INDEX

- AERIALS**, 154
 Alexanderson, Dr., 60, 105
 Amplifying Photo-electric Current, 86
 Anode, of Photo-electric Cell, 76
 Artificial Eye, 30
 Ayrton and Perry, 42
- BAIN**, 36
 Baird, J. L., 62, 132
 ———— Televisor, the, 134
 Baird's Receiving Apparatus, 136
 ———— Transmitting Apparatus, 134
 ———— System, Principle of, 133
 Bakewell, 37
 Belin and Holweck, 60, 95
 Bell System of Phototelegraphy, 49
- CAMBRIDGE Instrument Co.'s**
 Potassium in Helium Cell, 81
 Campbell Swinton, A. A., 59, 115
 Carey, 43
 Caselli, 36
 Cathode-rays, 109, 111, 112
 Cathode of Photo-electric Cell, 76
 Cathode-ray Systems, 44, 59, 95, 113, 116
 Cells, Photo-electric, 77
 Connelly and McTighe, 43
 Current-Voltage Curve, 83
 ———— Variation, 83
 Current Wave-length Curve, 84
- DAUVILLIER**, 60, 96
 De Bernouchi, 44
- Deflection of Cathode-rays, 111
 Diaphote, the, 43
 Disadvantages of Photo-electric Cell, 88
 Disc, Baird's Lens, 135
 ———— Spiral-slotted, 135
 ———— Slotted, 135
 ———— Jenkins' Prismatic, 101
 Discharge Tube, 110
- EDISON**, 38
 Einthoven Galvanometer, 47
 Electro-magnetic Radiation, 121
 ———— Theory of Light, 33
 Eye, the, 23
- FOG-PENETRATING powers of the**
 Noctovisor, 166
 Fribourg, 38
- GENERAL Electric Co.'s Potassium**
 in Vacuum Cell, 78
 ———— ———— Potassium in
 Argon Cell, 80
 Graham Bell, 41, 67
- HERSCHEL'S** Experiments, 161
 Hertz, 74
 Hertz' Experiments, 121
 Hick, Dr., 43
 How Light travels, 120
- ILLUMINANTS**, 119, 150
 Images, 127, 128
 Impressions, Persistence of, 26
 Inertia of Selenium, 70
 Infra-red Rays, 160, 162
 Invisible Rays, 161

- JENKINS and Moore, 60
 Jenkins' Prismatic Disc, 101
 — Shadowgraphs, 100
- KERR, 42
 Knudsen, 44
 Knudsen's Experiments, 53
 Korn, 45
- LA COUR's Phonic Drum, 99
 Langmuir's Mercury Vapour Pump, 75
 Lenses, 127
 Light, Electro-magnetic Theory of, 33
 — Refraction of, 126, 129
 Light-sensitive Cells, 140
 Light-sources, 119
 Light Waves, 122
 Lights and Shadows, 124
 Long-distance Television, 169
- MERCURY Vapour Pump, 75
 Middleton, 42
 Mihaly, 60, 97
 Mimault, 39
 Mirrors, 127
 Moore Lamp, the, 103
- NOCTOVISOR, the, 165
- OPTICAL Lever, the, 138
 Oscillograph, the Cathode-ray, 112
- PERSISTENCE of Impressions, 26
 Phonic Drum, the 167
 Phonovisor, the, 99
 Photo-electric Cells, 74, 76, 78
 — — Sensitivity of, 82
 — Current, Amplifying of, 86
 Photo-electric Current, Measuring of, 85
 Photographs, Transmission of, 19, 20
- Photophone, the 44
 Phototelegraphy, 19
 — Bell System of, 49
 Plurality of Light Sources, 143
 Pointolite Lamp, 48
 Poulsen-Korn System, 47, 48
 Prismatic Disc, 101
- RADIO Equipment, 152
 — Receiving, 156
 — Transmission, 156
 Ranger, R. H., 57
 Refraction of Light, 126, 129
 Requisites for Television, 148
 Rignoux and Fournier, 45, 92
 Rosing, 45, 114
 Ruhmer, 44, 91
- SELENIUM, 30, 40, 63
 — Cells, 66
 — — Performance of, 67
 — Inertia and Lag of, 70
 Senlecq, 40
 Sensitivity of the Photo-electric Cell, 82
 Shadow Cones, 125
 Shadowgraphs, 100
 Shelford Bidwell, 44, 67
 Short-wave Transmission, 153
 Synchronism, 150
 Szczepanik's Apparatus, 94
- TELAUTOGRAPH, the, 39
 Telectroscope, the, 40
 Telehor, the, 97
 Telephotograph, the, 55
 Telephone, Comparison with, 28
 Television, Definition of, 18
 — Problem of, 18
 Thermo-electricity, 42
 Thorne Baker Apparatus, 56
 Transatlantic Radio Pictures, 57
 — Television, 157

Tuning-fork Interrupter, 99

VARIATION Curve of Current-
Voltage, 83

Vavin, 38

Velocity of Light, 121

Vision in Darkness, 164

Visual Persistence, 25, 27

Visual Purple, 24

WAVE-LENGTH, 33

Wave-lengths, Table of, 32

Willoughby Smith, 40

ZWORYKIN's Cell, 88

PRINTED IN GREAT BRITAIN BY
RICHARD CLAY & SONS, LIMITED,
BUNGAY, SUFFOLK.

D. VAN NOSTRAND COMPANY

are prepared to supply, either from
their complete stock or at
short notice,

Any Technical or Scientific Book

In addition to publishing a very large and varied number of SCIENTIFIC AND ENGINEERING BOOKS, D. Van Nostrand Company have on hand the largest assortment in the United States of such books issued by American and foreign publishers.

All inquiries are cheerfully and carefully answered and complete catalogs sent free on request.

8 WARREN STREET - - - NEW YORK

