

# **RCA Victor**

## **Special Service Information**



**SERVICE DIVISION**

**RCA Victor Company, Inc.**  
**Camden, N.J.**

**A RADIO CORPORATION OF AMERICA SUBSIDIARY**

**REPRESENTATIVES IN PRINCIPAL CITIES**

# RCA Victor Service Information

Prepared By  
RCA Victor Service Division

The following information will be found useful when doing service work with various types of RCA Victor receivers, Victor Radio instruments and RCA Radiolas. In most cases the diagrams are self explanatory.

## MAGNETIC PICKUP CONNECTIONS

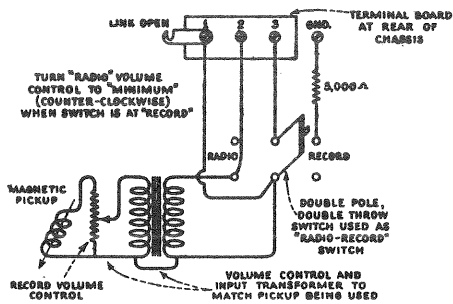

Figure 1—Connections to RCA Victor Models R-7, R-7A, R-7 D.C., R-7 L.W., R-9 and R-9 D.C.

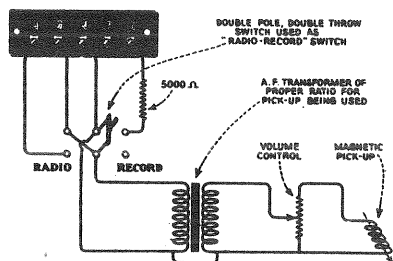

Figure 2—Connections to RCA Radiola 80 (with tone control) and RCA Radiola 82

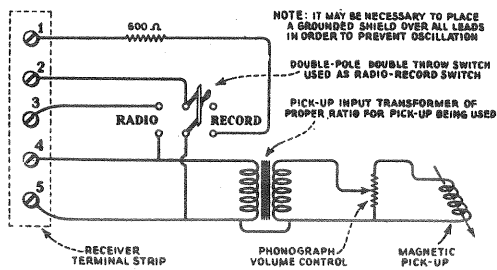

Figure 3—Connections to RCA Radiolas 42 and 48 and to Victor Radio R-14 and R-15

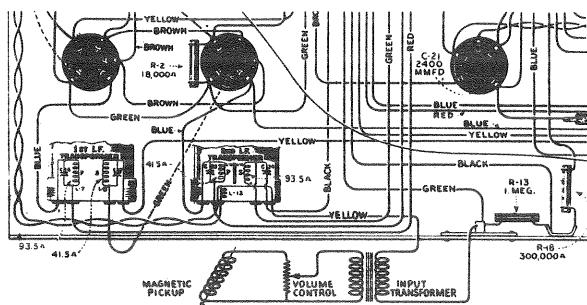

Figure 4—Connections to RCA Victor Model R-10

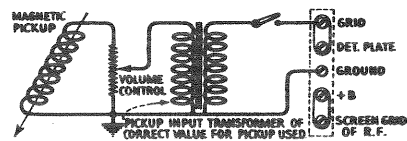
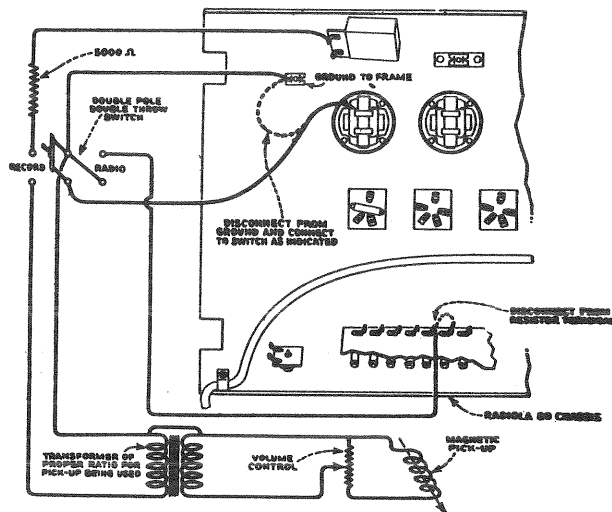

Figure 5—Connections to Victor Radio R-35 and R-39



WIRING NECESSARY FOR CONNECTING  
MAGNETIC PICK-UP TO RADIOLA 80

Figure 6—Connections to RCA Radiola 80 (without tone control)

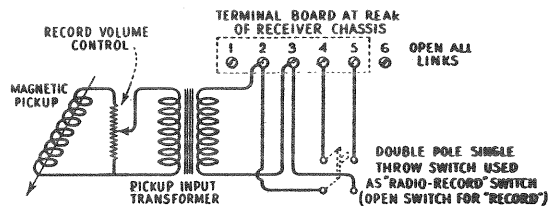

Figure 7—Connections to RCA Victor Model R-11

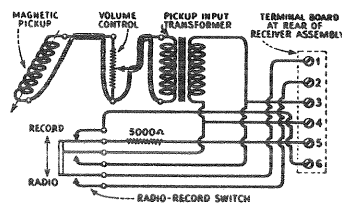

Figure 8—Connections to RCA Victor Models R-50 and R-55

## LOUDSPEAKER CONNECTIONS

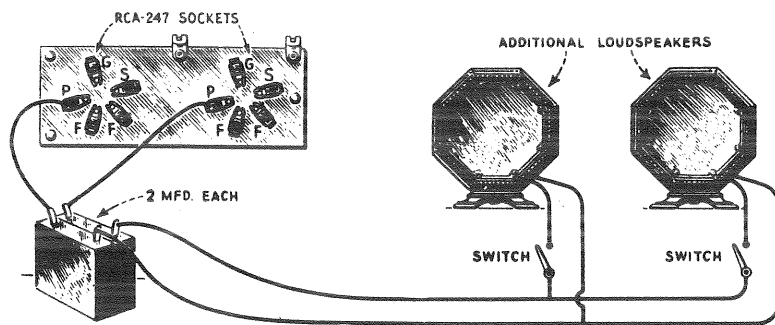

Figure 9—Connections for attaching additional loudspeakers to models using Pentodes in push-pull as the output amplifier

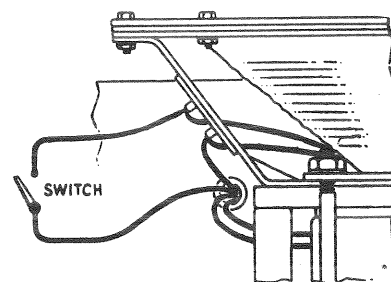

Figure 11—Method of connecting switch for disconnecting set speaker while using external speakers

### CONNECTING ADDITIONAL SPEAKERS TO MODELS USING SINGLE OUTPUT STAGE

In order to connect additional loudspeakers to models using a single output stage, the following variation must be made from the connections shown in Figures 9 and 10.

Connect the loudspeakers, the switches and one capacitor in the same manner as shown in Figures 9 and 10. The other capacitor (shown connected to the other plate) should be connected to the low side (+ B side) of the primary of the output transformer. As this connection varies with different receivers a circuit diagram of the receiver in question must be examined in order that the proper point can be located. If this is not feasible, connecting this capacitor to the chassis frame will usually give the desired results.

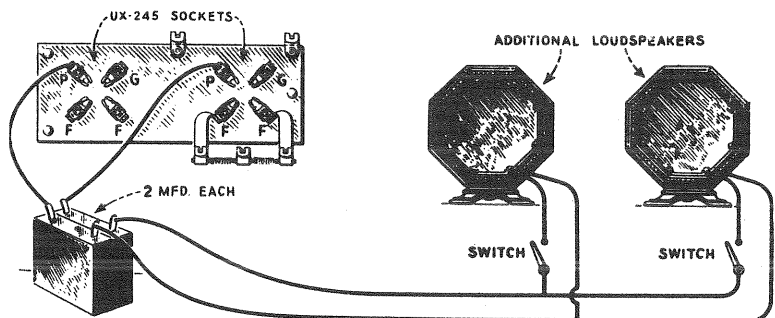

Figure 10—Connections for attaching additional loudspeakers to models using three-element tubes in push-pull for the output amplifier

## HEADPHONE CONNECTIONS

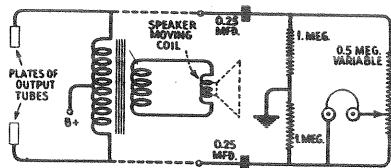

Figure 12—Connections to push-pull output stages when it is desired to vary volume without affecting radio output

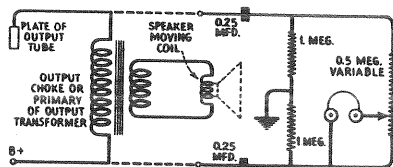

Figure 13—Connections to single output stages when it is desired to vary volume without affecting radio output

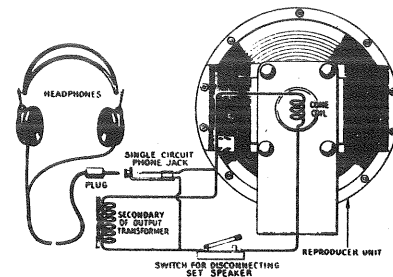

Figure 14—Connections to any receiver using dynamic type speaker. The volume can be varied only by the receiver volume control

## RCA VICTOR SHORT WAVE ADAPTOR CONNECTIONS

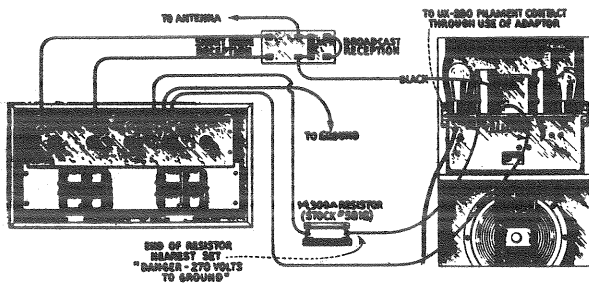

Figure 15—Connections to RCA Victor Model R-10

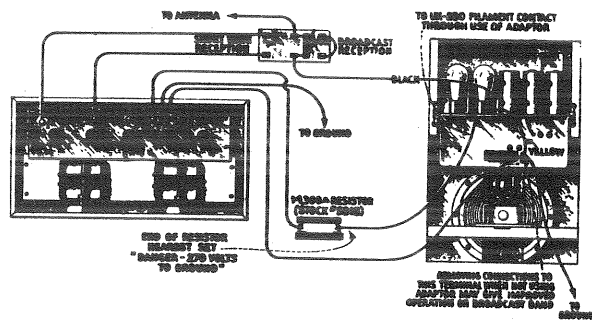

Figure 17—Connections to RCA Victor Models R-11, RE-18 and RAE-26

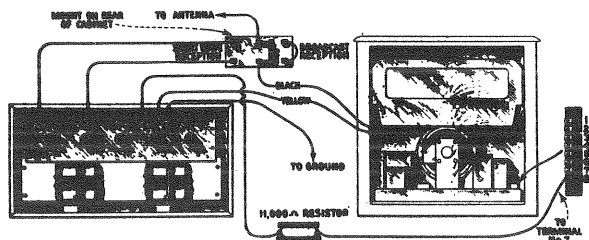

Figure 16—Connections to RCA Victor Models R-50, R-55, RAE-59 and RAE-79 (connect to amplifier No. 1 (Top) in Model RAE-79)

### CONNECTIONS TO RCA RADIOLA 64

Connect terminal No. 1 of the adaptor to the antenna and terminal No. 2 to the antenna binding post of Radiola 64. Terminal No. 4 of the adaptor goes to terminal No. 10 on the Radiola 64 S. P. U. Terminal No. 5 of the adaptor goes to terminal No. 9 on the S. P. U. Do not make any connections between this last mentioned terminal and ground.

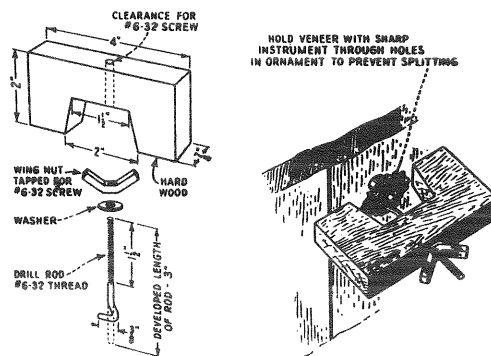

Figure 18—Details of special tool for removing door pulls on various Victor, Radiola and RCA Victor Models