

Instructions 23273

**Nine-Tube General Purpose
"All-Wave" Receiver**

(With CW Oscillator)

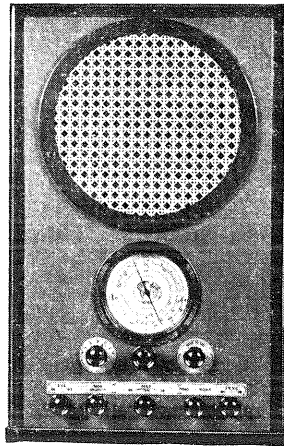

RCA Victor Company, Inc.

CAMDEN, N. J., U. S. A.

INTRODUCTION

This all-wave radio receiver utilizes the widely-recognized superheterodyne circuit and the broad range covered makes it an ideal general purpose receiver. The receiver is capable of operation through a continuous tuning range of from 540 to 18,000 kilocycles (555 to 16.7 meters) and also in the aviation long-wave services of 150 to 410 kilocycles (2,000 to 732 meters). A separate heterodyne oscillator unit is included to provide a beat-note for CW reception. All facilities provided in this instrument for reception beyond the limits of the standardized broadcast band (540 to 1500 kilocycles) are built-in as integral parts of the radio chassis—not simply connected to an existing chassis as a short-wave adaptor—resulting in distinctly superior performance.

To facilitate tuning as much as possible, the complete main tuning range is divided into five bands, each spread over the full span of the dial. These steps, or frequency bands, are quickly interchangeable by means of a range-switch controlled by a knob on the front panel. Also contributing to tuning ease and accuracy are the clock-type "full-vision" illuminated dial which is calibrated throughout in frequency, and the associated vernier (double-reduction ball-bearing) tuning drive. For greater flexibility in operation, a separate heterodyne oscillator unit is included which provides an audio beat-note for reception of CW signals. A switch is provided

for disconnecting the automatic volume control when desired and a radio sensitivity control is provided as an inter-channel noise suppressor or for adjustment of the r-f gain when the AVC is off. Pin-jacks are provided for connection of headphones and a switch is provided for connecting the output to either the loudspeaker or headphones.

The technically-informed user of this instrument naturally will be interested in its many advanced engineering features. Of chief importance is the use of tuned-radio-frequency amplification preceding the first heterodyne oscillator circuit to minimize extraneous signal interference (image-frequency response, etc.) and to improve the "signal-noise" ratio. Two i-r-f stages are included, one being common to all bands and the second used only in conjunction with the highest-frequency band to compensate for the inherently greater circuit losses obtained in that range. Additional features of note are: (1) Its automatic volume control operating uniformly at all carrier frequencies and (2) its high-powered (Class B) audio-output system utilizing the new "twin-amplifier" Radiotron RCA-53. In general, all of the best practices observed heretofore in modern high-grade receivers of the standard broadcast type are incorporated in this "all-wave" instrument, thus insuring excellent performance over the entire tuning range.

INSTALLATION

Location.—The instrument should be placed convenient to the antenna and ground connections and near an electrical outlet.

Tubes.—The instrument is equipped and tested at the factory with RCA Radiotrons and is shipped with these tubes installed. Before making the required external connections, however, it will be advisable to examine the tube installation, as one or more of the tubes, shields or dome terminal clips may have been jarred loose in shipment. Refer to the tube location diagram printed on the instrument label inside the cabinet and make certain:

- (1) That all tubes are in the proper sockets and pressed down firmly.
- (2) That all shields are rigidly in place over the tubes represented by double circles on the diagram.
- (3) That the spring connectors of the short flexible (grid) leads, shown on the diagram, are securely attached to the dome terminals of the proper tubes.

NOTE—The grid lead for the RCA-2B7 Radiotron must be enclosed by the cylindrical tube shield. A slot is provided at the bottom of this shield for entrance of the lead.

Antenna and Ground.—The efficiency of any antenna varies greatly with the frequency of incoming radio waves, a given length being excellent at certain frequencies and comparatively poor at others. For uniform results throughout a wide tuning range such as found in this instrument, therefore, an antenna of adjustable length would be desirable theoretically. From a practical standpoint, however, very good results will be obtained using two antennas of different lengths, one 24-29 feet for short-wave reception, and the other 50-100 feet for reception in the long-wave, standard broadcast and police bands, the lead-in considered as part of the total length in each case.

The shorter antenna may be used alone if preferred, but probably will not be satisfactory for receiving distant or low-powered stations in the standard broadcast band. Further, no advantage will be gained by its use on the shorter wavelengths unless it can be installed so that the majority of its length is unshielded (not contained in a building of metallic construction) and sufficiently remote from sources of man-made interference (such as house wiring, power lines, street-railways and passing automobiles) to prevent excessive noise. If these conditions cannot be fulfilled, it will be preferable to

erect a single antenna of compromise length (100-105 feet overall), which, in addition to providing excellent results in the standard broadcast band, will also favor reception in the short-wave broadcast bands located at 49, 31, 25 and 19 meters.

Best performance of this receiver on the shorter wavelengths can be insured by installation of the recently introduced "World-Wide" antenna system, available from your dealer as a convenient accessory kit. The advantages of this system are two-fold, its use providing: (1) A great improvement in efficiency, as evidenced by increased signal strength—often several times that obtainable with the conventional single-wire type and (2) a considerable decrease in local electrical interference (man-made static) which is apt to be objectionably severe at the higher frequencies. For densely-populated districts, therefore, this system is virtually a necessity.

Good reception in many installations will be obtained without connecting the instrument to an external ground, since the power-line characteristics often render a separate radio ground unnecessary. In any case, however, best results will be insured by grounding the set in the conventional manner to a water-pipe or radiator or to a metallic pipe or stake driven from five to eight feet into the soil. The ground lead when used should be short, preferably not more than 15 feet in length, and connected to a clean portion of the pipe or stake surface by means of an approved ground clamp.

A terminal board is provided at the rear of the receiver chassis for connection to the antenna and ground. Attach the antenna wire or lead-in to the left-hand terminal (marked "ANT") and the ground wire to the right-hand terminal (marked "GND"). Tighten both terminals with a screw-driver to insure permanent electrical connections.

Power Supply.—These equipments are furnished for operation from a 100-125/200-250 volts, 50-60 cycle supply. To insure correct tube operating voltages, internal connections may be changed to adapt the receiver for operation from 100-115, 115-125, 200-230 and 230-250 volt, 50-60 cycle supplies. (The receiver as shipped is connected for 115-125 volt operation.) Consult your local power company if you are in doubt as to the specific voltage of the supply. Reconnections when required should be made only by a competent technician; changes are as shown in Figure F.

After making certain that the instrument has been connected for the proper voltage, attach the power cord to the electrical outlet.

OPERATION

- (1) **Range Switch (Upper Left-hand Knob)**—This switch converts the receiver for operation within any of the tuning ranges provided. As indicated on the selector dial, the letters on the switch escutcheon signify:

X—Long-Wave Range—150 to 410 kilocycles (2000 to 732 meters). Airport band.

A—Standard Broadcast Band—540 to 1500 kilocycles (555 to 200 meters).

B—Police Band—1500 to 3900 kilocycles (200 to 77 meters). Services available within this band include police calls at 1574, 1712 and 2450 kilocycles, amateur radio "phone" communications between 1800 and 2000 kilocycles, and aviation communications (phone) between 2500 and 3500 kilocycles.

C—Short-Wave Range—3900 to 10,000 kilocycles (77 to 30 meters). Within the limits of this range are included two of the internationally-assigned short-wave broadcast bands. These are known as the 49 and 31 meter bands. (The portion of this range from 8000 to 10,000 kilocycles, which includes the 31 meter band, is preferably received on range D.)

D—Short-Wave Range—8,000 to 18,000 kilocycles (37.5 to 16.7 meters). This range embraces four of the standardized short-wave broadcast bands located at 31, 25, 19 and 16 meters, respectively.

- (2) **Station Selector (Upper Middle Knob with Crank)**—Scales X, A and B on the illuminated dial are calibrated in kilocycles and traversed by the lower end of the moving pointer. The upper end of the pointer traverses scales C and D which are calibrated in megacycles (affix three ciphers to convert to kilocycles). The scale portions covered by the police bands on scale B and by the standardized short-wave broadcast bands on scales C and D are bracketed and clearly identified; each police band is designated by the letter "P" and each broadcast band by numerals corresponding to the wavelength followed by the letter "M" (meters), such as "49M."

- (3) **Audio Volume Control (Upper Right-hand Knob)**—This control varies the output volume level by variation of the input to the audio amplifier. Sound level (volume) increases with rotation of this control in a clockwise direction.

- (4) **AVC Switch (Lower Left-hand Knob)**—This switch serves to turn the automatic volume control on and off. Turn to "Off" position for reception of CW signals, and "On" for reception of phone, MCW, ICW and damped wave signals.

- (5) **Radio Sensitivity Control (to right of AVC Switch)**—This control serves to vary the receiver sensitivity by variation of the bias on the r-f and i-f amplifier stages and is normally employed to control the volume when the AVC is "Off." When so employed, the Audio Volume Control should be set near its maximum position. This control should be in the extreme clockwise position when the AVC is "On," using Audio Volume Control to vary the volume. For operation where unusually high electrical noise levels exist, this control may be employed to reduce the inter-carrier noise levels when tuning with the AVC "On."

- (6) **Power Switch and Tone Control (Lower Middle Knob)**—The power switch operates at the counter-clockwise end of the control range. A slight clockwise rotation actuates the switch, causing illumination of the dial—indicative of normal operation. Treble response increases gradually to a maximum with continued clockwise rotation.

- (7) **Speaker-Phones Switch (right of Power Switch and Tone Control)**—This switch serves to connect the receiver output to either the loudspeaker or to headphones. Headphone cord tips are to be plugged into

the two pin-jacks located on the same mounting plate as the CW oscillator unit, available at the back of the set. It is recommended that high impedance (approximately 20,000 ohm) headphones be used.

- (8) **CW Oscillator Switch (Lower Right-hand Knob)**—This switch serves to turn the separate CW oscillator on and off. Switch should be "On" for reception of CW signals or when locating station carriers, and "Off" for all other (modulated) types of reception.

Procedure.—The actual operation is simple and not unlike that of more conventional instruments designed for the reception of standard broadcast programs alone. However, the full possibilities of any short-wave receiver cannot be attained unless the user has a practical knowledge of short-wave transmission behavior and operating schedules. It is therefore recommended that the appended Notes on Short-Wave Reception and the inserted Short-Wave Broadcasting Station List and Program Schedule be studied carefully.

A brief outline of the recommended operating procedure for reception of phone and modulated signals follows:

1. Set the Range Switch for the frequency range within which the desired station is included; turn AVC "On," CW Oscillator "Off," Radio Sensitivity Control to extreme clockwise position and select "Speaker" or "Phones" as desired.

2. Turn the Power Switch "On" and the Tone Control fully clockwise—for full-range reproduction. Wait a few seconds in order that the tubes may attain the proper temperature before attempting further operation.

3. Advance the Audio Volume Control to a position near the middle of its range and rotate the Station Selector until the dial indicator assumes a position coincident with the listed frequency of the desired station (on that scale which is designated by the letter corresponding to the range-switch setting). Then turn the selector very slowly over a narrow range on each side of that setting, advancing the Audio Volume Control further in a clockwise direction and repeating the tuning process, if necessary, until the signal is heard.

NOTE—This procedure is important—especially so for short-wave reception. Because of the wide band of frequencies covered by the short-wave ranges, tuning is critical (sharp). A station of suitable strength often will be imperceptible if passed through rapidly or in a haphazard manner. (Very weak signals may be located by turning the CW oscillator "On.")

4. After receiving the signal, turn the Audio Volume Control counter-clockwise until the volume is reduced to a low level. Then readjust the Station Selector accurately to the position mid-way between the points where the quality becomes poor or the signal disappears. This setting minimizes the proportion of background noise (static) and provides the fine quality of reproduction possible with this instrument.

5. Adjust the Audio Volume Control to the desired volume level. Once the desired audio level has been set, the automatic volume control functions to prevent overloading of the receiver for considerable variations of input signal strength.

6. If less treble response is preferred, rotate the Tone Control counter-clockwise to obtain the most pleasing quality of reproduction; static interference, when excessive, also may be reduced in this manner.

7. When through operating, turn the Tone Control fully counter-clockwise, thus switching "Off" the power.

For reception of CW signals, proceed as follows:

Turn AVC switch "Off" and CW switch "On." Procedure is the same as above except all references to volume control should refer to Radio Sensitivity Control and Audio Volume Control should be near the extreme clockwise position. Each station tuned in will be indicated by a whistle caused by the beating of the CW oscillator frequency with the signal frequency. This feature provides unmistakable signal indication and may also be used when tuning signals other than CW, noting the presence of the signal with the oscillator "On" and tuning the station in finally with the oscillator turned "Off."

NOTES ON SHORT-WAVE RECEPTION

While the design of this instrument is such that no previous experience or special skill is required for proper operation, its full possibilities can be realized only by those familiar with the general characteristics of transmission on the shorter wavelengths. The following notes are a summary of extensive data compiled mainly by experimentation and should be found both interesting and helpful, especially to beginners in the field of short-wave reception.

Broadcast transmission at 49 meters is most reliable when received from a distance of 300 miles (500 kilometers) or more, although good reception at distances greater than 1500 miles (2400 kilometers) can be expected only when a large portion of the signal path lies in darkness.

Thirty-one (31) meter stations afford greatest reliability of service to receivers situated at a distance exceeding 800 miles (1300 kilometers). Good reception from distant stations in this band is possible both day and night.

Reception from stations operating in the 25 meter band is most common when a span of 1000 miles (1600 kilometers) or more separates the receiver and transmitter. Such transmission over distances of less than 2000 miles (3200 kilometers), will be received best during daylight hours. The more distant stations, however, can still be heard well after nightfall under favorable conditions.

In the 19 meter band, stations situated at a distance of 1500 miles (2400 kilometers) or greater will be found most satisfactory. Signals in this band will generally be heard during daylight hours—rarely after nightfall or when any appreciable portion of the transmission path is in darkness. Wavelengths below 19 meters are useful only when transmitted entirely through daylight and over long distances (2000 miles or more); ordinarily they cannot be received after sunset.

Transmitted signals of any wavelength are known to divide into two components—the “ground” wave and the “sky” wave. The former remains close to the earth’s surface, providing reliable service only over short distances from the broadcasting station.

The sky wave, however, travels into the higher layers of the atmosphere and is reflected back to the earth’s surface at an appreciable distance from the station. With short-wave signals, the sky wave usually does not return within the radius covered by the ground wave, resulting in a so-called dead-spot region within which reception is impossible or extremely unsatisfactory. The length of the region wherein such conditions are effective is known as the skip distance, varying greatly from day to night and from summer to winter approximately as shown in Table I.

When attempting to receive distant or foreign stations, the time standards observed at various longitudes throughout the world must be considered. At 8:00 P. M. in New York or 7:00 P. M. in Chicago, it is of the next day—1:00 A. M. in London, 2:00 A. M. in most of Europe and 11:00 A. M. in Australia. On the American continents, therefore, regular evening broadcasts from Europe will be received in the late afternoon and from Australia in the early morning. Special programs, however, are frequently transmitted from European stations at times chosen for evening reception in America.

Although reception on the short wavelengths is less affected by atmospheric or static and good results may be had in midsummer even during a thunder storm, the reverse is true of man-made interference. Electrical machinery such as trolleys, dial telephones, motors, electric fans, automobiles, airplanes, electrical appliances, flashing signs and oil burners create far more interference to the shorter waves than to frequencies in the standard broadcast band (200 to 555 meters).

While the foregoing statements are valid, many other factors may so influence the transmission of short waves that exceptions are probable in certain locations. Experience in the operation of short-wave receivers in a given location is the best guide as to what to expect in reception at various times.

Any person interested primarily in short-wave reception will find membership in the International Short-Wave Club of great value. The club is a non-commercial organization and issues a monthly magazine (International Short-Wave Radio) which contains up-to-date information pertaining to short-wave broadcasting, amateur activities and commercial, police and aircraft services. The annual membership fee, including the magazine subscription, is one dollar (\$1.00), U. S. Currency; single copies of the periodical may be procured by non-members for ten cents (\$0.10) U. S. Currency, each. Address International Short-Wave Club, P. O. Box 713, Klon-dyke, Ohio, U. S. A.

Table I—Effect of Time of Day and Season of Year on Short-Wave Transmission*

Wavelength (Meters)	Ground Wave Range		Sky Wave (Mid-Summer) Approximate Range				Sky Wave (Mid-Winter) Approximate Range			
			Noon		Midnight		Noon		Midnight	
	Miles	Kilom.	Miles	Kilom.	Miles	Kilom.	Miles	Kilom.	Miles	Kilom.
100	90	145	—90	—145	90—600	145—960	90—100	145—160	90—2500	145—4000
49	75	120	100—200	160—320	250—5000	400—8000	200—600	320—960	400—∞	640—∞
31	60	97	200—700	320—1125	1000—∞	1600—∞	500—2000	800—3200	1500—∞	2400—∞
25	50	80	300—1000	480—1600	1500—∞	2400—∞	600—3000	960—4800	2000—∞	3200—∞
19	35	56	400—2000	640—3200	2500—∞	4000—∞	900—4000	1450—6400	X	X
15	15	24	700—4000	1125—6400	X	X	1500—∞	2400—∞	X	X

∞—Unlimited distance.

X—Ordinarily cannot be heard.

*Time and season apply to transmitting station. Distances specified are based on relatively high-power transmission and favorable conditions of reception.

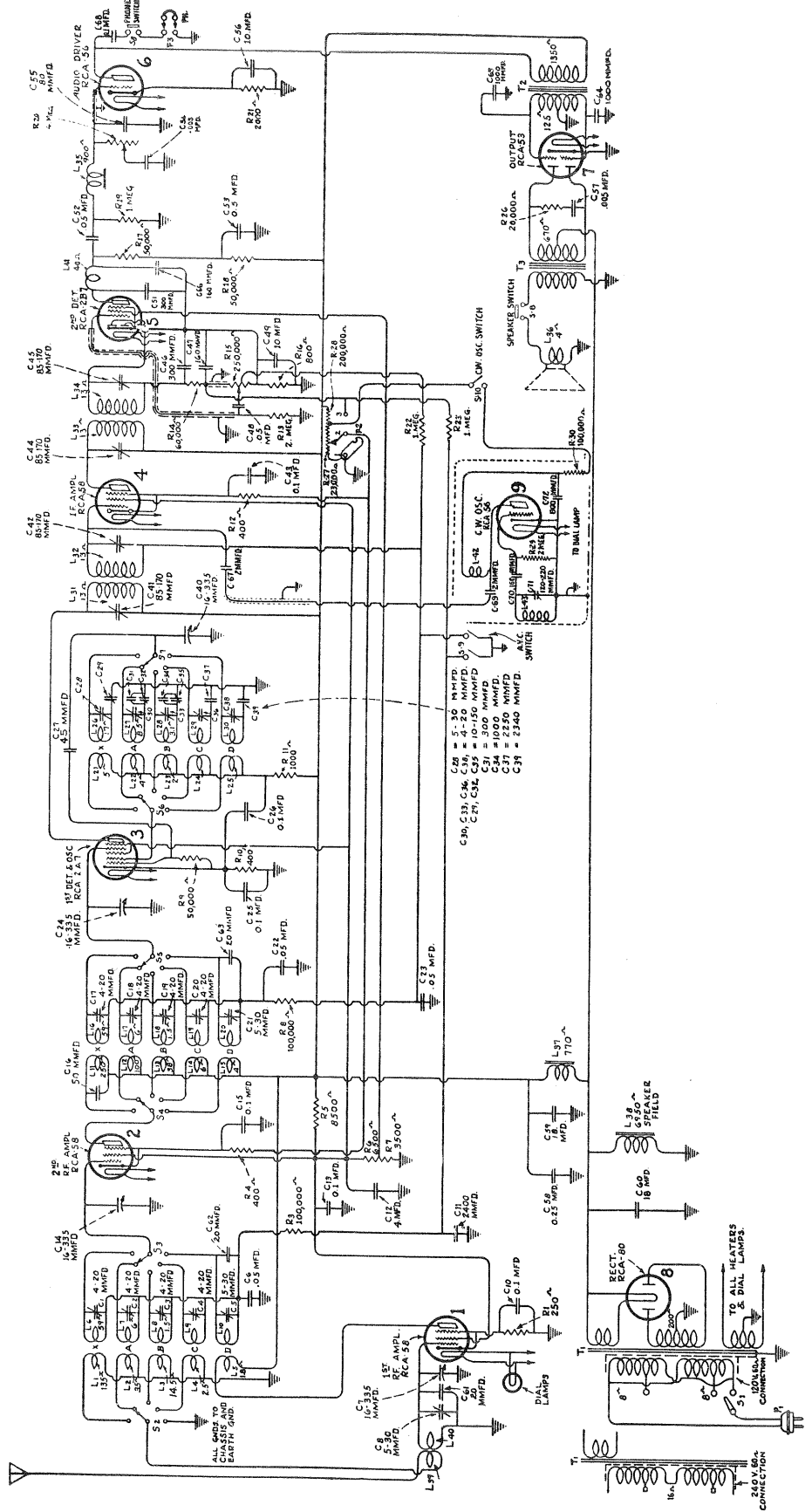

Figure A—Schematic Circuit Diagram—Additional Resistor—750,000 ohms—Parallel to R-28 on some models

Additional Resistor—750,000 ohms
Parallel to R-28 on some models

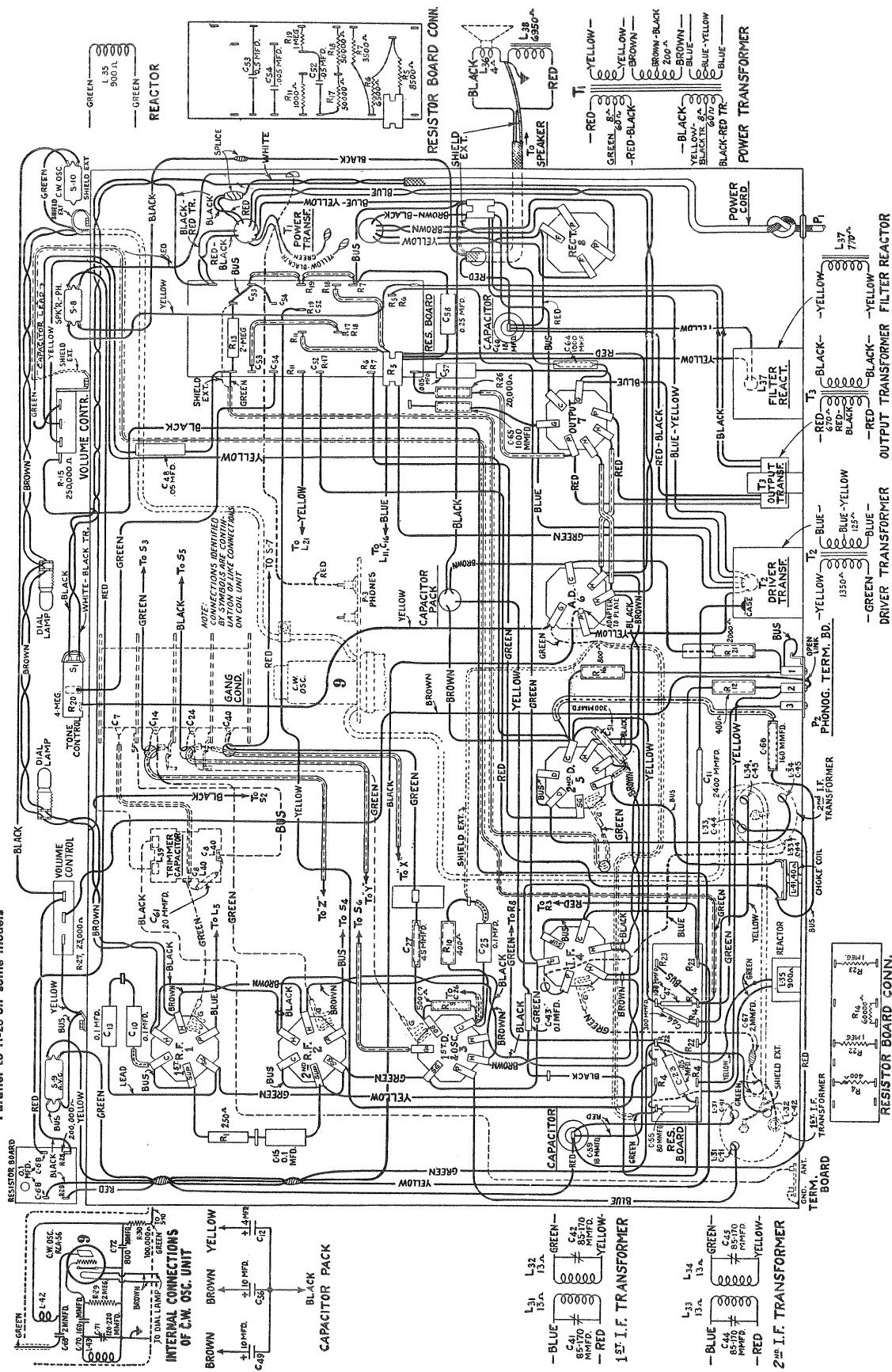
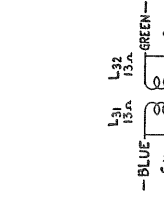
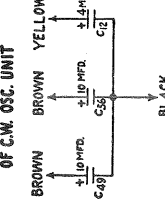
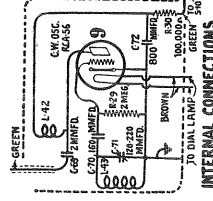

Figure B—Chassis Wiring



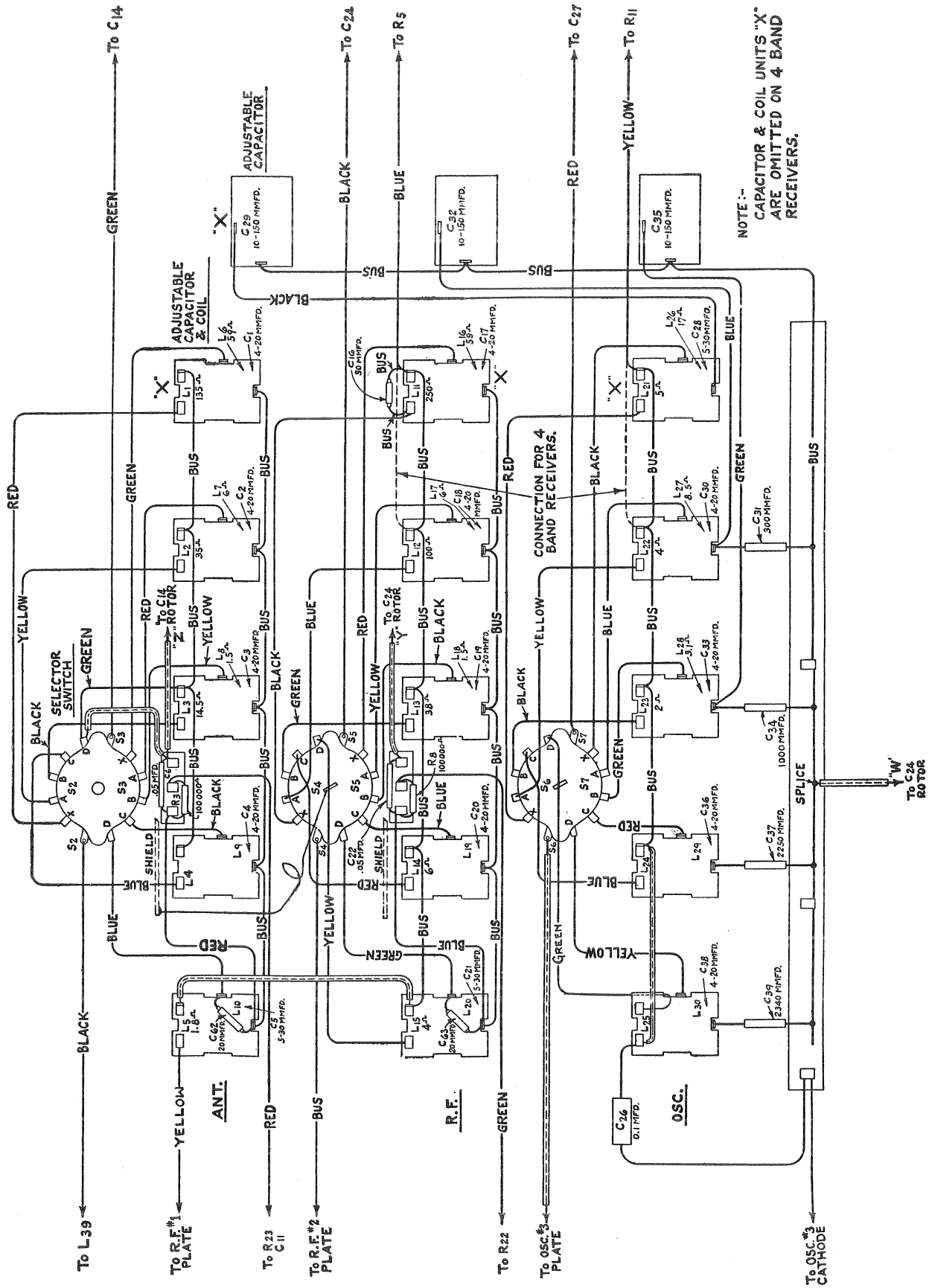

Figure C—Wiring Diagram of Coil Assembly

SERVICE DATA

Electrical Specifications

Voltage Rating.....100-125 Volts and 200-250 Volts
 Frequency Rating.....50-60 Cycles
 Power Consumption.....110 Watts
 Type and Number of Radiotrons
 3 RCA-58, 1 RCA-2A7, 1 RCA-2B7, 2 RCA-56,
 1 RCA-53, 1 RCA-80—Total 9
 Type of Circuit
 Straight Super-Heterodyne for all frequencies with
 Class "B" Output Stage.
 Undistorted Output.....6 Watts

This all-wave super-heterodyne receiver is of the continuous tuning type utilizing a straight super-heterodyne circuit in all bands. The bands are as follows:

Selector Switch Position	Frequency Range (Kilocycles)	Wave-Length Range (Meters)
X	150-410	2000-732
A	540-1500	555-200
B	1500-3900	200-77.0
C	3900-10000	77.0-30
D	8000-18000	37.5-16.7

REMOVE FOUR NUTS & LOCKWASHERS SHOWN FOR REMOVING BOTTOM SHIELD OF COIL ASSEMBLY.

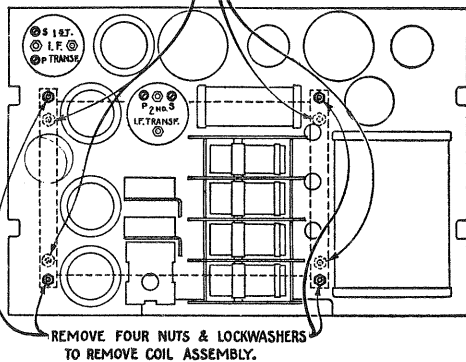

Figure D—Location of nuts and lockwashers holding coil assembly

The circuit consists of an R. F. stage using Radiotron RCA-58, a combined oscillator and first detector using Radiotron RCA-2A7, an I. F. stage using RCA-58, a second

detector and A. V. C. using RCA-2B7, an A. F. driver using RCA-56, and a Class "B" output stage using an RCA-53. The RCA-80 functions as the rectifier in the power supply circuits.

The foregoing Radiotrons and circuit functions apply to bands X, A, B and C only. In the case of band D, an additional R. F. stage utilizing an additional Radiotron RCA-58 is used. This is to increase the sensitivity and image frequency selectivity and to reduce the interference caused by tube hiss and 445 K. C. signals or static.

The intermediate frequency is 445 K. C. The use of this frequency gives an especially good image frequency ratio and makes easier alignment of the oscillator at the higher frequency bands.

In order to receive pure C W signals, an I. F. heterodyne oscillator has been provided. This oscillator is an RCA-56 that operates at a 1000-cycle higher frequency than the I. F. An adjustable capacitor is provided so that the pitch of the heterodyne frequency may be varied throughout the audible range.

Mechanical Construction

The chassis consists of two major assemblies, which must be disassembled for certain repair work. These assemblies consist of the chassis proper, including the main frame, power transformer, etc., and the coil assembly. The coil assembly consists of fifteen transformers supported upon individual tubular bakelite forms, each fastened to a separate porcelain strip upon which the coil terminals are mounted with their associate trimmer capacitor. This entire assembly with the selector switch is grouped in a shielded compartment which is mounted in the base of the main chassis assembly.

In order to remove this assembly it is necessary to remove the four nuts shown in Figure D and unsolder the connections of the fifteen leads shown in Figure C at the points where they connect to the main chassis. The leads should be allowed to remain on the coil assembly. After this is done, the coil assembly may be removed and repairs to it or to the main chassis may be easily made. If a coil or its associated trimmer is to be replaced, then only the bottom shield of the coil assembly must be removed. This is done by removing the four nuts that hold it to the chassis studs. This is shown in Figure D.

Line-up Capacitor Adjustments

This receiver is aligned in a similar manner to that of a standard broadcast band receiver. That is, the three main tuning capacitors are aligned by means of three trimmers in each band and on the three lowest frequency bands a series trimmer is adjusted for aligning the oscillator circuit. The other two bands do not require this low frequency trimmer, it being fixed in value. In the case of band D, it is necessary to adjust four trimmers due to the additional R. F. stage used.

RADIOTRON SOCKET VOLTAGES

120 Volt, A. C. Line

Radiotron No.	Control Grid to Cathode, Volts	Screen Grid to Cathode, Volts	Plate to Cathode, Volts	Plate Current, M. A.	Filament or Heater, Volts
RCA-58, R. F.	**2.0	100	255	6.0	2.6
RCA-58, S. W. R. F.	**2.0	100	255	6.0	2.6
RCA-2A7, Det.-Osc.	**2.5	100	250	*5.0	2.6
RCA-58, I. F.	**2.0	100	255	6.0	2.6
RCA-2B7, 2nd Det.-AVC	**1.5	35	105	1.5	2.6
RCA-56, A. F. Driver	**12.0	—	245	6.0	2.6
RCA-53, Output	0	—	300	36.0	2.6
RCA-80, Rectifier	640 R. M. S. Plate to Plate	—	—	130 per Plate	5.0
RCA-56, CW-Osc.	**	—	20	0.1	2.6

* Voltages and current apply to detector portion of tube.

** These voltages cannot be measured because of the high resistance of the circuits.

The intermediate frequency amplifier is aligned in a similar manner to that of standard broadcast receivers except that it is aligned at 445 K. C. In order to properly align the receiver, it is essential that the Stock No. 9050 Test Oscillator be used. This oscillator covers the frequencies of 90 K. C. to 25,000 K. C. continuously, has good stability and includes an attenuator. In addition to the oscillator, a 300 ohm resistor for use as a "dummy" antenna, a non-metallic screwdriver (such as Stock No. 4160), and an output meter are required. The output meter should be preferably a thermocouple galvanometer connected either across or in place of the cone coil of the loudspeaker.

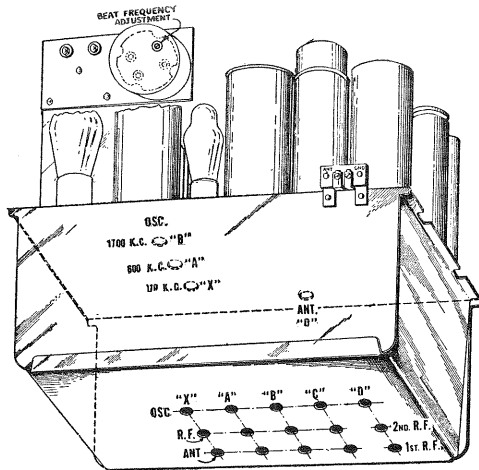

Figure E—Location of line-up capacitors.

To align the intermediate frequency circuits, connect the output of the external oscillator to the grid of the first detector. For the R. F. and oscillator adjustments, the oscillator output should be connected to the antenna and ground terminals of the receiver with a 300 ohm resistor inserted in series with the antenna lead. In many cases, however, the signal strength obtained with this direct connection will be too great to permit proper alignment, even at the minimum setting of the oscillator attenuator. When this is true, the external oscillator must be loose-coupled to the receiver. This is done by connecting the 300 ohm resistor between the antenna and ground terminals of the receiver and attaching a short length of wire to the antenna post. Lay the free end of this wire across the oscillator case, adjusting its position as necessary to obtain the degree of pickup required.

The output of the external oscillator should be at the minimum value necessary to obtain a deflection in the output

meter when the volume control is at its maximum position. All adjustments are made for a maximum deflection in the output meter.

The accuracy of line-up of each band may be checked without touching the trimmer condensers, by the use of the tuning wand, Stock No. 6679.

One end of the wand consists of a brass cylinder. When this is inserted in a coil the effective inductance of the coil is lowered.

The other end of the wand contains a special finely divided iron suitable for use at radio frequencies. When this is inserted in a coil the inductance is raised.

To use the tuning wand a signal is first tuned in at the frequency at which a check is desired on alignment. The wand is then inserted slowly in the Antenna and R. F. transformers, using first one end and then the other end of the wand. Unless the alignment is perfect, it will be found that the power output indicated by the meter will be increased to a peak for a critical position of the wand in the coils.

The end of the wand required indicates whether the coil is high or low.

Of course, alignment correction at the high frequency end of a tuning range should be accomplished by the use of the trimmer condenser. If alignment correction should be required at the low frequency end of a tuning range it may be accomplished by sliding the end coil of the transformer. The winding farthest from the trimmer panel is pushed toward the trimmer panel to increase the inductance, and farther away to decrease the inductance. On band D coils, the last two or three turns may be pushed in a similar manner to obtain the proper inductance.

This adjustment should not be attempted unless a quite appreciable improvement will result (as shown by the tuning wand).

The following chart gives the details of all line-up adjustments. The receiver should be lined up in the order of the adjustments given on the chart. Refer to Figure E for the location of the line-up capacitors.

The CW oscillator beat frequency may be adjusted by means of the trimmer capacitor shown in Figure E. (It may be necessary to slightly loosen the shielding cover to gain access to this screw.) A weak modulated or telephone signal should be accurately tuned-in with the oscillator "off". The oscillator should then be turned "On" and the trimmer screw adjusted until a 1000 cycle note is obtained.

Transformer Connections

The power transformer of the 50-60 cycle receiver uses two tapped primary windings. By connecting them in parallel or in series, the receiver may be used either on 110 or 220 volt lines. Figure F shows the proper manner of making the various connections possible for this transformer.

External Oscillator Frequency	Dial Setting	Location of Line-Up Capacitors	Position of Selector Switch	Adjust for	Number of Adjustments To Be Made
445 K. C.	Any setting that does not bring in station.	Top of chassis.	Any position that does not bring in station.	Maximum output.	4
370 K. C.	370 K. C.	Bottom of chassis.	X	Maximum output.	3
175 K. C.	Set for signal.	Top of chassis.	X	Maximum output while rocking dial back and forth.	1
1400 K. C.	1400 K. C.	Bottom of chassis.	A	Maximum output.	3
600 K. C.	Set for signal.	Top of chassis.	A	Maximum output while rocking dial back and forth.	1
3900 K. C.	3900 K. C.	Bottom of chassis.	B	Maximum output.	3
1710 K. C.	Set for signal.	Top of chassis.	B	Maximum output while rocking dial back and forth.	1
10 M. C.	10 M. C.	Bottom of chassis.	C	Maximum output. (See Note)	3
15 or 18 M. C.	15 or 18 M. C.	Bottom and top.	D	Maximum output. (See Note)	4

NOTE—It is important to note, when aligning bands C and D, that two peaks will be observed on the trimmers for the oscillator and for the first detector. The correct oscillator peak is the one obtained using the lower trimmer capacitance, whereas the correct detector peak is the one obtained with the greater capacitance. It is essential that the proper peak be chosen, as otherwise tracking and sensitivity will be very poor at other frequencies. When adjusting the detector trimmer, the tuning capacitor should be rocked, since there is reaction on the oscillator tuning.

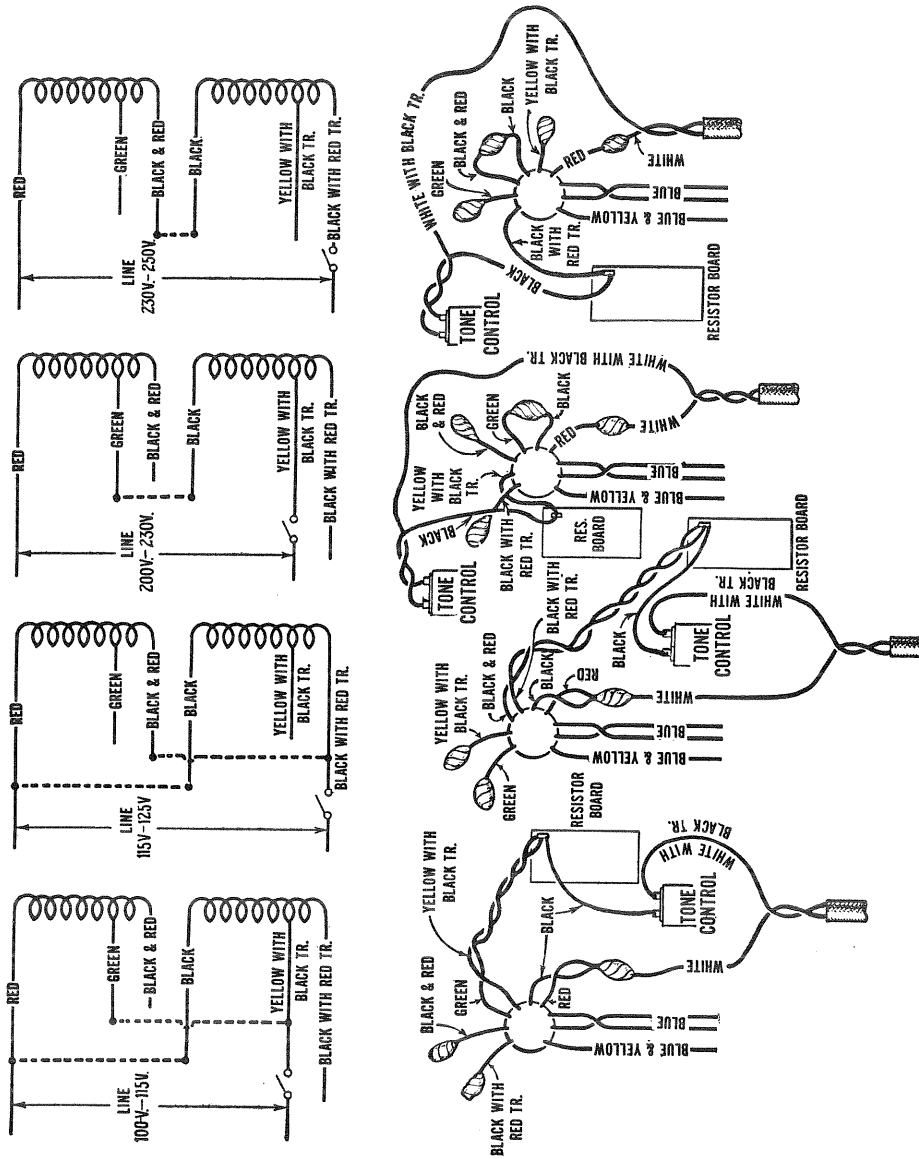

Figure F—Power Transformer Connections (50-60 cycles)

REPLACEMENT PARTS

Insist on genuine factory tested parts, which are readily identified and may be purchased from authorized dealers

Stock No.	DESCRIPTION	List Price	Stock No.	DESCRIPTION	List Price
RECEIVER ASSEMBLIES					
2747	Contact cap—Package of 5	\$0.50	6633	Coil and capacitor—Oscillator coil and capacitor assembly—150-410 kilocycles—5-band (L21, L26, C28)	\$1.40
2816	Resistor—1,000 ohms—Carbon type— $\frac{1}{2}$ watt (R11)—Package of 5	1.00	6634	Coil and capacitor—Antenna coil and capacitor assembly—540-1,500 kilocycles—4- or 5-band (L2, L7, C2)	1.86
3056	Shield—Output Radiotron shield—Package of 2	.40	6635	Coil and capacitor—R. F. coil and capacitor assembly—540-1,500 kilocycles—4- or 5-band (L12, L17, C18)	2.00
3076	Resistor—1 megohm—Carbon type— $\frac{1}{2}$ watt (R19, R22, R23)—Package of 5	1.00	6636	Coil and capacitor—Oscillator coil and capacitor assembly—540-1,500 kilocycles—4- or 5-band (L22, L27, C30)	1.40
3114	Resistor—50,000 ohms—Carbon type— $\frac{1}{4}$ watt (R9)—Package of 5	1.00	6637	Coil and capacitor—Antenna coil and capacitor assembly—1,500-4,000 kilocycles—4- or 5-band (L3, L8, C3)	1.56
3118	Resistor—100,000 ohms—Carbon type— $\frac{1}{4}$ watt (R3, R8)—Package of 5	1.00	6638	Coil and capacitor—R. F. coil and capacitor assembly—1,500-4,000 kilocycles—4- or 5-band (L13, L18, C19)	1.66
3435	Resistor—250 ohms—Carbon type— $\frac{1}{2}$ watt (R1)—Package of 5	1.00	6639	Coil and capacitor—Oscillator coil and capacitor assembly—1,500-4,000 kilocycles—4- or 5-band (L23, L28, C33)	1.40
3470	Resistor—6,500 ohms—Carbon type—1 watt (R6)—Package of 5	1.10	6640	Coil and capacitor—Antenna coil and capacitor assembly—4,000-10,000 kilocycles—4- or 5-band (L4, L9, C4)	1.54
3526	Resistor—2,000 ohms—Carbon type— $\frac{1}{2}$ watt (R21)—Package of 5	1.00	6641	Coil and capacitor—R. F. coil and capacitor assembly—4,000-10,000 kilocycles—4- or 5-band (L14, L19, C20)	1.60
3527	Resistor—800 ohms—Carbon type— $\frac{1}{2}$ watt (R16)—Package of 5	1.00	6642	Coil and capacitor—Oscillator coil and capacitor assembly—4,000-10,000 kilocycles—4- or 5-band (L24, L29, C36)	1.34
3529	Socket—Dial lamp socket	.32	6643	Coil and capacitor—Antenna or R. F. coil and capacitor assembly—3,000-18,000 kilocycles—4- or 5-band (L5, L10, C5—L15, L20, C21)	1.52
3555	Capacitor—0.1 mfd. (C26, C68)	.36	6644	Coil and capacitor—Oscillator coil and capacitor assembly—8,000-18,000 kilocycles—4- or 5-band (L25, L30, C38)	1.54
3572	Socket—7-contact Radiotron socket—First detector and oscillator	.38	6675	Shaft—Shaft for condenser drive assembly—Comprising shaft, ball race with retainer and set screw	.35
3594	Resistor—50,000 ohms—Carbon type— $\frac{1}{2}$ watt (R17, R18)—Package of 5	1.00	6679	Wand—Tuning wand for R. F. and oscillator adjustments	.75†
3597	Capacitor—0.25 mfd. (C58)	.40	6889	Capacitor—18. mfd. (C60)	1.55
3602	Resistor—60,000 ohms—Carbon type— $\frac{1}{4}$ watt (R14)—Package of 5	1.00	6890	Transformer—First intermediate frequency transformer (L31, L32, C41, C42)	2.40
3616	Capacitor—300 mmfd. (C51)	.34	6891	Transformer—Second intermediate frequency transformer (L33, L34, C44, C45)	2.40
3622	Shield—Second detector Radiotron shield	.36	6892	Tone control (R20)	1.50
3641	Capacitor—0.1 mfd. (C10, C15, C25)	.35	6953	Volume control—Radio sensitivity control (R27)	1.25
3643	Capacitor—.005 mfd. (C57)	.25	6955	Shield—Second R. F. Radiotron Shield	.25
3711	Capacitor—80 mmfd. (C55)	.40	6956	Shield—Radiotron shield top	.15
3719	Socket—7-contact Radiotron socket	.30	7484	Socket—5-contact Radiotron socket	.35
3771	Resistor—8,500 ohms—Carbon type—3 watt (R5)	.25	7485	Socket—6-contact Radiotron socket	.40
3845	Capacitor—2,340 mmfd. (C39)	.50	9042	Transformer—Power transformer—105-250 volts—50-60 cycles (T1)	6.84
3846	Capacitor—2,250 mmfd. (C37)	.50	9046	Transformer—Power transformer—105-125 volts—25-40 cycles	9.22
3848	Capacitor—300 mmfd. (C31)	.30	9050	Oscillator—Test oscillator—90-25,000 K. C.	29.50†
3849	Capacitor—50 mmfd. (C16)	.30	10194	Ball—Steel ball for condenser drive assembly—Package of 20	.25
3861	Capacitor—Adjustable trimmer (C29, C32, C35)	.78	MISCELLANEOUS PARTS		
3863	Resistor—400 ohms—Carbon type— $\frac{1}{2}$ watt (R4, R10, R12)—Package of 5	1.00	4224	Bezel—Station selector dial bezel	.50
3864	Capacitor—300 mmfd. (C46)	.30	4225	Ring—Dial glass retaining ring—Package of 5	.95
3865	Capacitor—160 mmfd. (C47)	.30	4226	Escutcheon—Engraved—"AVC-on-off"—"Radio Sensitivity"—"Power Tone-off-on"—"Speaker-Phone"—"CW-OSC-off-on"	.85
3888	Capacitor—.05 mfd. (C6, C22, C23, C52)	.25	4227	Escutcheon—Audio sensitivity control escutcheon	.70
3901	Capacitor—.05 mmfd. (C48)	.36	4228	Escutcheon—Range switch escutcheon	.35
3931	Capacitor—45 mmfd. (C27)	.30	4229	Knob—Audio volume control tone control or radio sensitivity control knob—Package of 5	1.15
3932	Capacitor—.0024 mfd. (C11)	.30	4230	Knob—"AVC"—"CW-OSC"—"Speaker-Phone" and range switch knob—Package of 5	1.15
3973	Capacitor—1,000 mmfd. (C64, C65)	.34	4231	Knob—Station selector knob—Package of 5	1.15
4019	Capacitor—1,000 mmfd. (C34)	.34	6614	Glass—Station selector dial glass	.30
4030	Bracket—Tone or volume control mounting bracket	.14	6954	Adapter—5-prong adapter	.32
4033	Capacitor—.20 mmfd. (C61, C62, C63)	.34	OSCILLATOR ASSEMBLIES		
4103	Shield—First detector and R. F. Radiotron shield	.20	3118	Resistor—100,000 ohms—Carbon type— $\frac{1}{4}$ watt (R30)—Package of 5	1.00
4104	Shield—I. F. Radiotron shield	.20	3634	Capacitor—160 mmfd. (C70)	.34
4160	Trimmer adjustment wrench and screwdriver	1.00	3682	Shield—Radiotron shield	.22
4205	Coil—Second detector choke coil (L41)	.50	4027	Capacitor—800 mmfd. (C72)	.44
4207	Capacitor—0.1 mfd. (C13, C43)	.34	4221	Jack—Pinjack—Package of 2	.45
4217	Switch—Single pole—Single throw—"CW-OSC" (S10)	1.15	4222	Shield—Coil shield	.28
4218	Switch—Double pole—Single throw—"AVC" (S9)	1.00	6950	Resistor—2 megohms—Carbon type— $\frac{1}{4}$ watt (R29)—Package of 5	1.00
4219	Switch—Single pole—Double throw—"Speaker-Phone" (S8)	1.90	6899	Coil—Oscillator coil (L42, L43, C69)	.38
4220	Resistor—200,000 ohms—Carbon type—1 watt (R28)—Package of 5	1.10	6951	Capacitor—Adjustable capacitor—120-220 mmfd. (C71)	.70
6112	Cushion—Rubber cushions for chassis—Package of 4	.25	6952	Cable—3-conductor shielded cable	.32
6136	Resistor—3,500 ohms—Carbon type—1 watt (R7)—Package of 5	1.10	6952	Cable—Single conductor shielded	.24
6188	Resistor—2 megohms—Carbon type— $\frac{1}{2}$ watt (R13)—Package of 5	1.00	7484	Socket—5-contact Radiotron socket	.35
6278	Resistor—750,000 ohms—Carbon type— $\frac{1}{2}$ watt (R31)—Package of 5	1.00	REPRODUCER ASSEMBLIES		
6300	Socket—4-contact Radiotron socket	.35	8969	Cone—Reproducer cone complete (L36)—Package of 5	6.35
6303	Resistor—20,000 ohms—Carbon type— $\frac{1}{2}$ watt (R26)—Package of 5	1.00	9438	Reproducer complete	6.88
6512	Capacitor—.005 mfd. (C54)	.28	9439	Coil assembly—Field coil, magnet and cone support (L38)	5.22
6603	Condenser—4-gang variable tuning condenser (C7, C14, C24, C40)	3.80			
6604	Capacitor—0.5 mfd. (C53)	.50			
6605	Transformer—Output transformer (T3)	1.48			
6606	Reactor—Filter reactor (L37)	1.66			
6607	Reactor—Tone control reactor (L35)	1.14			
6608	Transformer—Audio driver transformer (T2)	2.04			
6609	Capacitor—18. mfd. (C59)	1.10			
6612	Volume control—Audio volume control (R15)	1.20			
6613	Drive—Variable condenser drive assembly—Complete	1.00			
6626	Capacitor pack—Comprising one 4. mfd., and two 10. mfd., capacitors (C12, C49, C56)	1.86			
6628	Capacitor and coil—Antenna coil and capacitor assembly—8,000-18,000 kilocycles—4- or 5-band (L39, L40, C8)	1.50			
6629	Switch—5-band selector switch	3.48			
6630	Switch—4-band selector switch	3.48			
6631	Coil and capacitor assembly—Antenna coil and capacitor—150-410 kilocycles—5-band (L1, L6, C1)	2.16			
6632	Coil and capacitor—R. F. coil and capacitor assembly—150-410 kilocycles—5-band (L11, L16, C17)	2.10			

† Full Discount not allowed.