

SHAKE, RADIO SERVICE ENGINEER

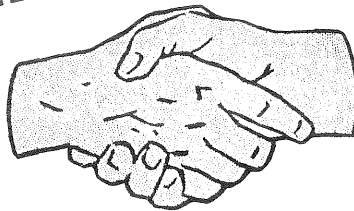

You are interested in servicing every kind of radio apparatus; RCA makes all kinds of radio apparatus and is interested in having it properly serviced.

—You are interested in the stabilization of the radio service business. So is RCA. Everything that benefits radio in any of its branches benefits RCA.

—Between you and RCA there is a natural partnership. You can depend on RCA to see things from your point of view —You can depend on RCA, as your partner, to support you in anything that benefits the radio service business in particular and the radio industry and the public in general.

—You can depend on RCA to produce accurate Test Instruments designed for your needs and priced for your pocketbook.—You can depend on RCA for Replacement Parts for RCA Victor sets that are built with the same precision as the original parts.—You can depend on RCA to furnish you with complete technical information on its products.—You can depend on the RCA trademark making it easier for you to obtain customers and easier to keep them satisfied.

TEAM UP WITH RCA . . . SEE YOUR RCA PARTS DISTRIBUTOR FOR

*Test Equipment . . . Oscillators . . . Output Meters . . . Special Tools
Antenna Systems . . . Cathode Ray Test Equipment . . . RCA Victor
Replacement Parts . . . Phonograph Modernization Kits . . . Auto Radio Locks*

RCA PARTS  **DIVISION**

RCA MANUFACTURING CO., INC.

CAMDEN, NEW JERSEY

Why RCA Victor Instruments Are Easily Serviced



The Model Shop

OF VITAL interest to every RCA Victor Dealer and Service Engineer is the RCA Victor Model Shop. It is pictorially presented here for the first time.

There are two primary functions of the Model Shop. Here every new RCA Victor receiver, every new test instrument is born. Drawings for new merchandise come from the Engineering Staff and, after careful study, the first 100 units are turned out by hand. If there is anything in the blue printed specifications that proves impractical under actual shop conditions, it is quickly disclosed and the Engineering Staff is called for consultation and necessary change.

But the actual construction of new circuits, new or improved use of tubes, new merchandise, is only the beginning of the activities of the Model Shop. When the hand-made sets are completed, they are housed in dull, drab-looking cabinets having the exact acoustical properties of the cabinets designed for the receivers—"Greys," they are called—and are shipped to all points of the compass, to every section of the United States, but only to RCA Victor Field En-

gineers. These men put the new receivers through their paces in every conceivable way.

In the very shadow of the most powerful broadcasting stations, all new receivers are given the acid test for performance. On the burning plains of Texas, they must perform with the

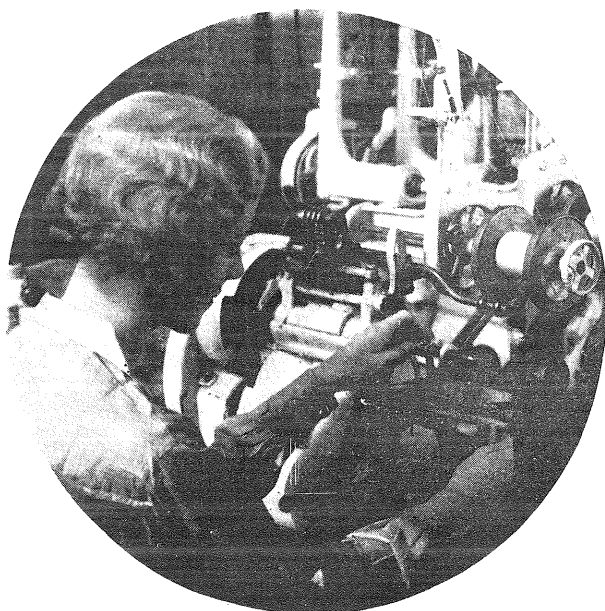



same fidelity of tone that characterizes their performance in the highest points of the Rockies. Each RCA Victor Field Engineer virtually lives with the new instrument while it is in his possession, and finally returns it with his report and recommendations. Again the Model Shop tests the returned receivers; gives careful consideration to every recommended change. Then when the Engineers are satisfied that the receiver is the finest that can be produced, blueprints and hand-made, field-tested sets are turned over to the production department, and a new RCA Victor is on its way to hundreds of thousands of homes.

Practically every operation in the manufacture of a radio set is performed in the Model Shop, and all of them by hand. Semi-automatic machinery is used in coil-winding, braiding, etc., but for the most part, every operation is a hand operation. And yet the Model Shop occupies only a small section of one floor in one of the many RCA Victor buildings.

The construction of new receivers from blueprints is but one of the two major functions of the Model Shop. Indeed, it is the primary function. But no less important to the RCA Dealer and Service Engineer is the fact that in this shop the work of the Service Engineer is constantly being simplified. Behind all this there is but one objective—to make the work of the Service Engineer less complicated, to make it easier for the Engineer to make repairs and replacements on RCA Victor sets.

Here our own staff of Field

Engineers comes frequently, and from every quarter of the globe. With them, they bring the ideas they have personally developed while making field tests of the Grey-housed models. And with these ideas they go to work. Every facility of the shop is at their command. The Engineering Laboratory, with its costly, modern, scientific equipment, is open to the visiting Field Engineer. A work bench is assigned, tools are provided and here the RCA Field Engineer proceeds to build into the set personally the changes that he believes will prove most helpful to the army of Service Engineers. But that does not mean always that the recommended changes will be made. It develops sometimes that what might be gained by such changes is more than lost in other ways. But conferences of engineers and countless tests demonstrate the practicability of any suggested plan. Every suggested change or improvement is given careful consideration. That improvements are constantly being made is attested by photographs on the following page, which illustrate the ease with which all parts of the typical RCA Victor chassis may be reached by the Service Engineer, as compared with the intricate job of getting at the older models.

KEY TO ADJACENT VIEWS

Upper Left: Aligning Gang Tuning Capacitors

Center Left: General View of Electrical Laboratory

Bottom Left: Impregnating R F Coil Assemblies

Upper Right: Model Shop. Main Production Line

Center Right: Shielding a Braided Cable

Bottom Right: Grey Cabinets, housing hand-made chassis for field tests

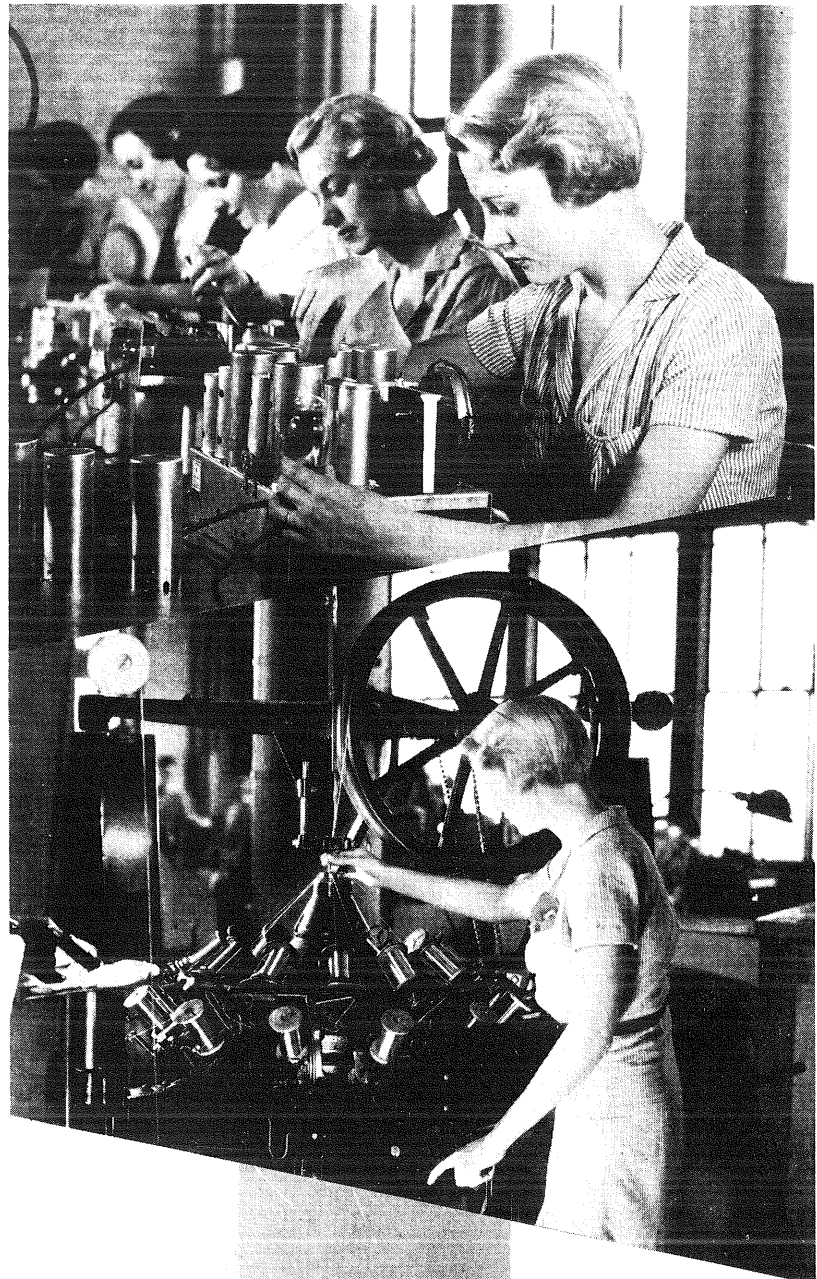

These pictures show how the RCA Model Shop simplifies the Radio Service Engineer's problems

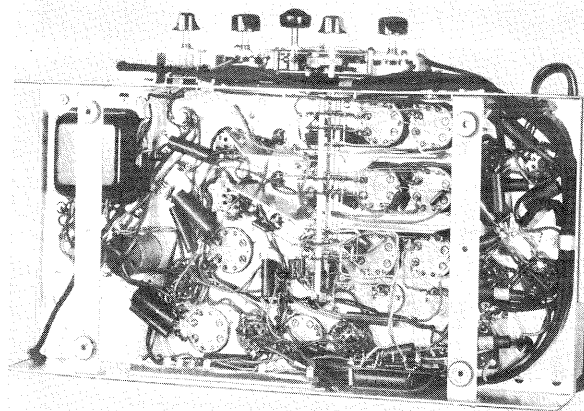
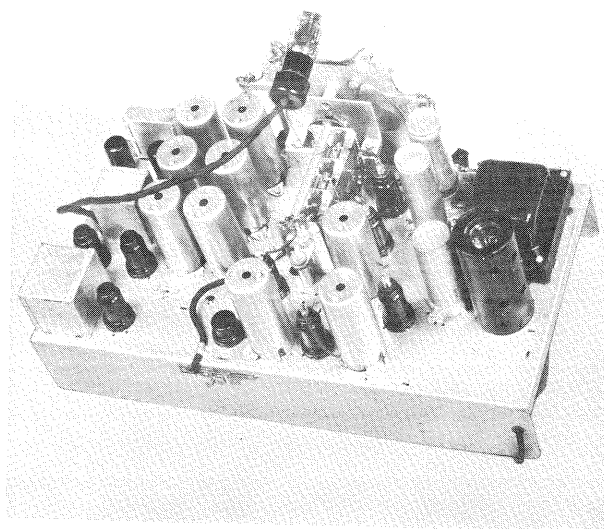

Year after year RCA Victor simplifies and makes easier the sale and servicing of RCA Victor instruments, attachments and parts . . . Daily, the Model Shop is striving to make easier and more profitable the work of the Service Engineer.



Regulated Power Unit

TMV-118-B



A Constant Source of "B" Voltage

FOR

Designers, Development Laboratories, Electrical Laboratories, Experimenters, Engineers, Manufacturing Tests, Production Inspection, Physical Laboratories, School Demonstration Rooms, Scientific Service Organizations, Universities, etc., etc.

Supplies pure D.C. voltage without ripples . . . Automatically compensates for variation in load and in line voltage

The Regulated Power Unit, No. 9560

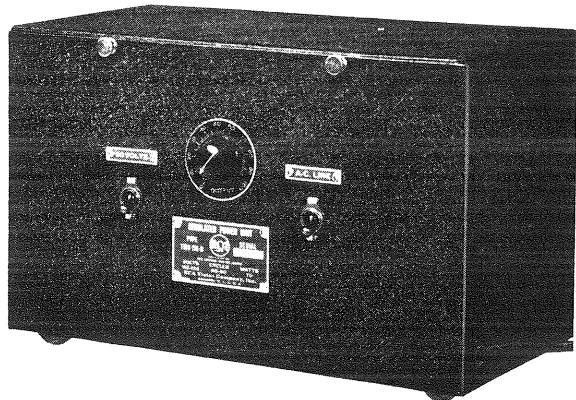

Front view of RCA Regulated Power Unit shows accessible controls for 90-volt tap and a. c. line

A Constant "B" Supply

The RCA Regulated Power Unit is a product of our research engineering department, designed to meet the demands of our factory, test and engineering departments for self-regulated voltage power source for its test equipments.

RCA Victor, like other recognized manufacturers in the radio industry, tests and re-tests its products many times during their orderly movement from the design laboratories to final completion.

Nearly every type of test apparatus employs vacuum tubes and the plate or "B" voltage supplied to these tubes must not vary. If the apparatus is to be depended upon for any degree of accuracy, the test load on the tube must be constant. Batteries or other forms of unregulated "B" voltage supply devices have failed to meet these requirements.

The RCA Regulated Power Unit has answered demands for this service so successfully in our own factories and laboratories that it is certain to assume definite leadership

when its performance and possibilities become known to others. It will be found particularly valuable for—

1. Permanent installations of vacuum tube voltmeters, standard signal generators, beat frequency oscillators, field intensity meters, and comparable devices where it is necessary to have an automatically regulated "B" supply available.

2. Design laboratories which need a source of B current to use in the development of detector circuits, I. F. circuits, A. V. C. circuits or other portions of a receiver prior to the design of the power supply for the complete equipment.

3. Test voltage services which must remain constant under varying conditions of line voltage or load.

4. Many scientific service organizations which operate on a scale comparable to that of the engineering laboratories of radio manufacturers. By means of the RCA Regulated S. P. U. they may isolate portions of circuits and study suspected difficulties independently instead of being forced to rely upon the associated power supply. Those who serve a territory where battery receivers are still in use will find the Regulated S. P. U. to be helpful in meeting the test requirements of varied circuits.

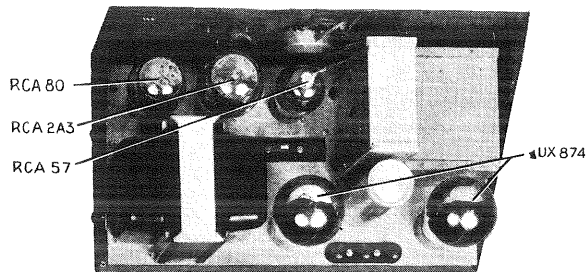

Power Unit from top with hinged cover removed to show compact design and sturdy construction

The RCA Regulated Power Unit

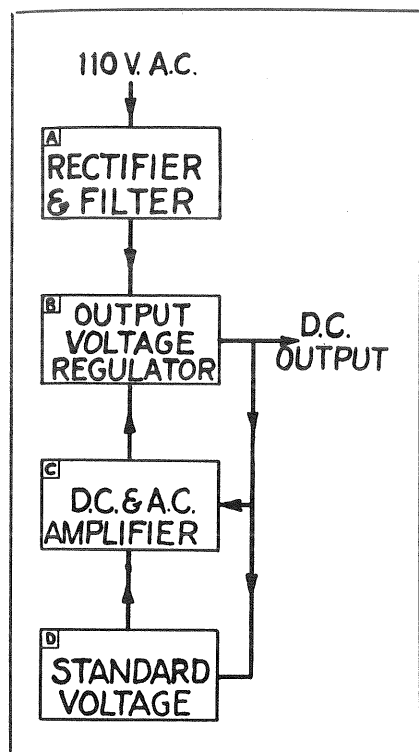

Block Diagram Regulated Power Unit

Circuit Description . . .

The block diagram at the left illustrates the method whereby the performance shown in the curves on page 4 is obtained. The Regulated Power Unit consists of a conventional rectifier and filter (A) and a means of governing the amplitude of this rectified voltage which is delivered to the output binding posts.

The regulator (B) which in this device is a tube, is placed in series with the output terminal. As the regulation is varied, the output voltage is changed so that the tube functions as an automatic rheostat, holding the d. c. output voltage constant with either variable line voltage, variable load current, or both. Reference to the diagram on this page shows that the d. c. output voltage is also balanced against a standard voltage (D) which in this case is a tube. The balanced voltage is applied to the grid of a d. c. amplifier (C). If the line voltage or load current is varied, the difference in voltage between the standard voltage at (D) and the output voltage will appear across the grid of the d. c. amplifier (C).

This amplified difference voltage is caused to actuate the regulator (B) by applying it to the grid of this tube. Thus any variations in the d. c. output voltage are amplified and the regulator (B) attempts to readjust to hold a constant difference between the output voltage and the standard voltage (D).

The block diagram indicates that the unit (C) is both a d. c. and an a. c. amplifier. Should any a. c. be present at the d. c. output terminals it is amplified by the unit (C), impressed on unit (B) in reversed phase and so tends to cancel.

In the Regulated Power Unit the standard voltage (D) is an 874 glow tube. A portion of the output voltage through the use of a potentiometer is compared with this voltage. By varying the position of the potentiometer arm the d. c. output regulated voltage may be varied.

Specifications

TUBES—RCA 80, Rectifier; RCA 2A3, Voltage Regulator; RCA 57, D. C.-A. C. Amplifier; RCA 874, Voltage Standard; RCA 874, Regulator for 90-Volt Tap.

The RCA Regulated Power Unit will deliver voltages between 135 volts and 180 volts d. c. at a current drain between 10 m. a. and 80 m. a. with line voltages of 110 volts \pm 10% or 120 volts \pm 10% with a load voltage variation of not over 2%. As illustrated by

the curves on page 4, even higher voltages may be obtained at reduced current drains.

In addition, the RCA Regulated Power Unit will deliver both 90 volts and 135 volts for operation of equipment such as the TMV-180 RCA Signal Generator Type TMV-180 which required both of these voltages. The 90-volt tap will deliver up to 20 m. a. at 90 volts, while the output from the main section is 40 m. a. at 135 volts.

Net Price, F. O. B. Camden **\$39⁵⁰** (With Tubes)

THE RCA PARTS DIVISION, Camden, N. J.

Performance Data—RCA Regulated Power Unit

The accompanying curves indicate the remarkable regulation constancy of the RCA Regulated Power Unit under varying load conditions. Note the negligible variation in output voltage under operating fluctuations more severe than are usually encountered on most power circuits.

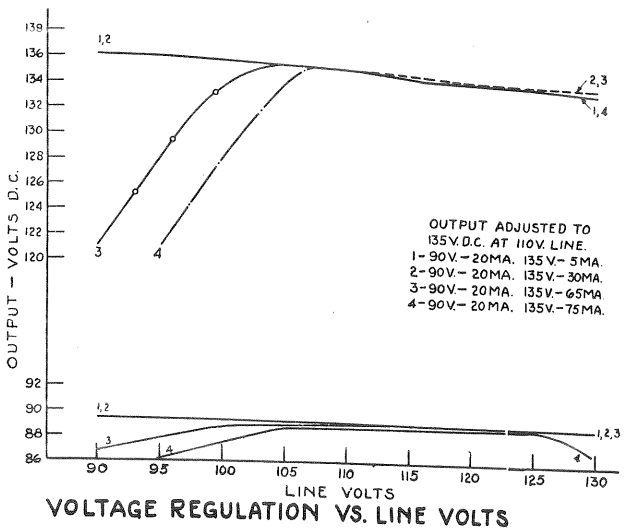
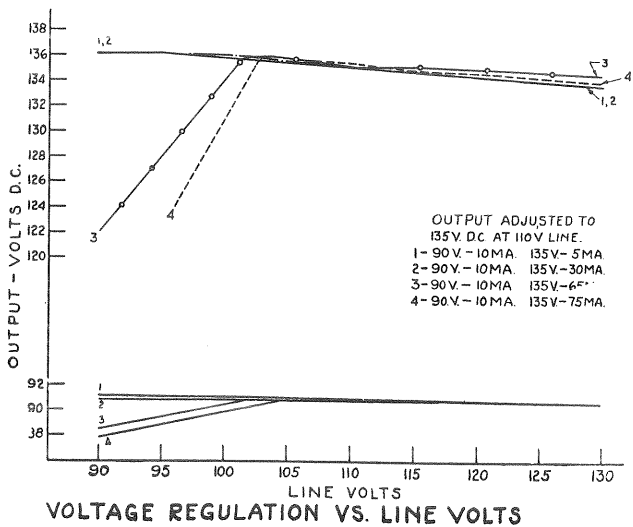
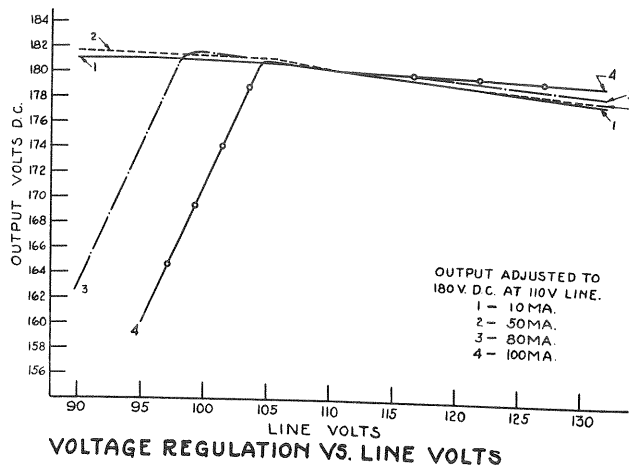
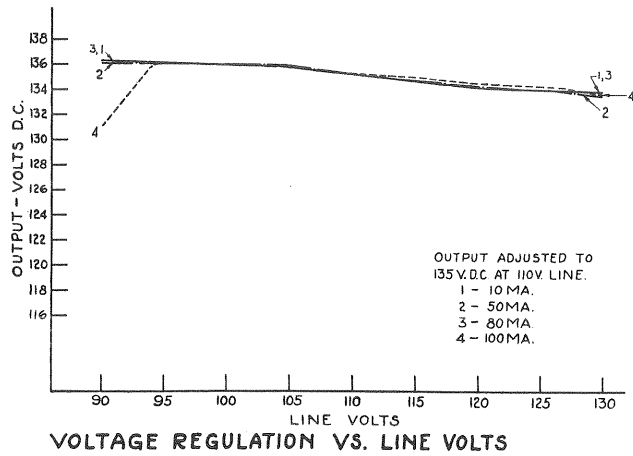
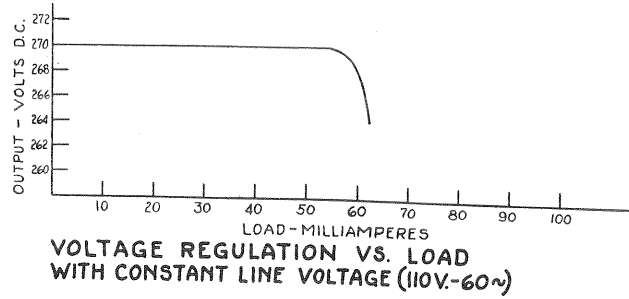
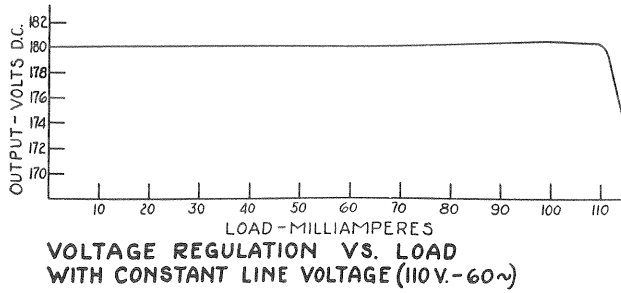

RCA Tools and Accessories

The following tools and accessories are useful for servicing Radio Receivers, Combinations and Short-Wave Instruments of all types and manufacture.

Alignment Tool



Stock No. 4160

Net Price \$0.60

The Stock No. 4160 Alignment Tool is a bakelite shaft combination screwdriver and socket wrench. The metal screwdriver bit is so shaped that the increase in capacity caused by its touching a trimmer screw is offset by the reduction in inductance caused by its shape. This is very important when making adjustments on all-wave receivers where the screwdriver must be inserted through the end of the coil. The socket end fits the main tuning capacitor trimmer adjustment screws used on numerous RCA Victor Receivers. The bakelite shaft is $\frac{1}{32}$ " diameter, which gives entrance to $\frac{1}{4}$ " holes, used on older model Radiola receivers.

Tuning Wand



Stock No. 6679

Net Price \$1.10

The Stock No. 6679 Tuning Wand is a special alignment tool which makes possible the checking of alignment in all-wave receivers without disturbing the adjustment of the trimmer capacitors. The tool consists of a bakelite rod having a brass cylinder at one end and a special finely divided iron core at the other end. Inserting the brass cylinder into a coil lowers its inductance, while inserting the iron increases the inductance. From this it is evident that before adjusting trimmers, the adjustment may be checked by inserting each end of the wand into the coil. Proper adjustment is evidenced by a reduction in output with either end of the wand inserted into the coil.

Fibre Screwdriver



Stock No. 11890

Net Price \$0.38

The Stock No. 11890 fibre screwdriver is especially useful in making tuning capacitor trimmer adjustments in circuits which are critical and which might be misaligned if a metal tool were used. It is made of hard fibre and either end may be used in making adjustments.

Knurled Nut Wrench

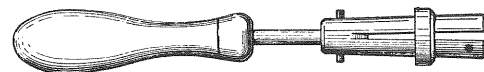

Stock No. 10982

Net Price \$1.20

The Stock No. 10982 Knurled Nut Wrench is a special wrench designed for tightening or removing the knurled nuts such as are used with toggle type switches. These nuts are ordinarily impossible to remove or tighten without marring. The wrench will hold a nut from $\frac{5}{8}$ " to $\frac{1}{2}$ " diameter. The overall length is $8\frac{1}{2}$ ".

Riveting Punch



Stock No. 10987

Net Price \$0.50

The Stock No. 10987 Riveting Punch is a special metal punch for use with a riveting anvil. The punch may be used with the rivets usually used on radio receivers and permits the service man to make a factory type repair, instead of using machine screws to replace rivets. The punch is $\frac{5}{16}$ " in diameter and $5\frac{1}{2}$ " long.

Off-Set Screwdrivers



Stock No. 3064
Net Price \$0.50

Stock No. 2930
Net Price \$0.50

The Stock Nos. 3064 and 2930 Off-Set Screwdrivers are useful for making adjustments to remote control units and other small screws that are inaccessible with an ordinary screwdriver. The No. 3064 screwdriver is $2\frac{1}{2}$ " long while No. 2930 has an overall length of $4\frac{3}{8}$ ".

Riveting Anvil



Stock No. 10988

Net Price \$0.70

The Stock No. 10988 Off-Set Riveting Anvil is a special anvil that permits riveting in places ordinarily inaccessible. It is to be used in conjunction with a riveting punch such as Stock No. 10987. The Anvil is $\frac{5}{16}$ " in diameter and $3\frac{1}{2}$ " long.

Socket Wrench



Stock No. 10983

Net Price \$1.80

The Stock No. 10983 Socket Wrench is a special flexible end socket wrench designed for adjusting the alignment screws of the 1929 and 1930 Victor Receivers, Models R-32, R-35, etc. The overall length is $8\frac{3}{4}$ ".



TEST OSCILLATOR

NEW

A

Laboratory Instrument for Service Engineers

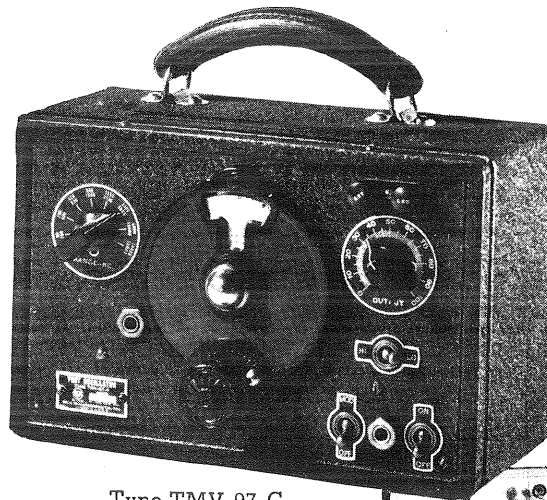

Type TMV-97-C

NET PRICE

\$34.50

STOCK No. 9595

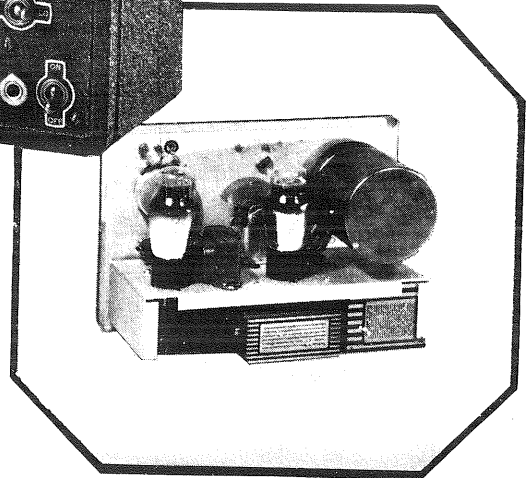

No longer must you content yourself with a Test Oscillator having high leakage, poor calibration, unsymmetrical modulation or any of the usual undesirable features of most oscillators. The new RCA Test Oscillator overcomes these and all other features heretofore considered unavoidable in instruments of this type. While this new instrument retains the general appearance of its predecessors, its performance and flexibility have been improved to the point where it definitely gives laboratory type performance.

★ **90 KC. to 25,000 KC.** Frequency range covers all r-f and i-f alignment points of all receivers. Eight overlapping bands.

★ **High Output.** Check the table at the bottom of this page for the high output voltages available from this instrument.

★ **Low Leakage.** Copper shielding and scientific design give low leakage at the minimum output position.

★ **Oscillograph Jack.** Single circuit jack across tuning capacitor facilitates connection of Frequency Modulator for oscillograph operation.

★ **Frequency Meter.** Phone jack and switching gives operation as heterodyne frequency meter; useful for checking the unknown frequency of stations or oscillators.

COMPARE THESE R. F. OUTPUT VOLTAGES

Range—KC.	Switch at Low Position		Switch at High Position Max. Volts
	Minimum	Maximum	
90- 200	Less Than 1 Microvolt	2 Millivolts	0.2
200- 400	1 Microvolt	2 Millivolts	0.2
400- 800	1 Microvolt	2 Millivolts	0.2
800- 1500	1 Microvolt	2 Millivolts	0.2
1500- 3100	5 Microvolts	1 Millivolt	0.1
3100- 6800	10 Microvolts	1 Millivolt	0.1
6800-14000	20 Microvolts	1 Millivolt	0.1
14000-25000	40 Microvolts	1 Millivolt	0.1

FEATURES

FREQUENCY RANGE

The output frequency range extends from 90 KC. to 25,000 KC. by means of eight overlapping bands. This range covers all radio frequency and intermediate frequency line-up points of *all* receivers. The frequency range is covered entirely by the fundamental frequency of the oscillator, no harmonics being used.

MODULATION

A separate tube modulates the radio frequency output with a 400 cycle sine-wave voltage. Compare on your oscillograph this modulation with your present oscillator. There is a panel switch for operating the oscillator either with or without modulation. A panel jack permits applying an external modulating frequency voltage such as a beat frequency oscillator or phonograph output to the R.F. signal.

OSCILLOGRAPH OPERATION

Convenient operation with the RCA Oscillograph and the RCA Frequency Modu-

lator is accomplished by a sweep circuit jack and operation without modulation. This is a very important feature because of the increasing popularity of the oscillograph method of circuit alignment.

HETERODYNE FREQUENCY METER

By plugging in a pair of headphones in the modulation jack, and placing the modulation switch at the unmodulated position, the modulator tube operates as a detector and the zero beat method of frequency checking may be used. This is very useful to amateur operators for checking the frequency of an unknown transmitting station.

R. F. OUTPUT VOLTAGES

A two-position toggle switch combined with a new variable attenuator circuit provides two ranges of output R.F. voltages. The switch gives approximately a 100:1 ratio of voltage change. The minimum range of the high position overlaps the maximum range of the low position, thereby giving a continuous variation over the entire range. The approximate minimum and maximum ranges are given on the reverse page.

MINIATURE MAGIC BRAIN

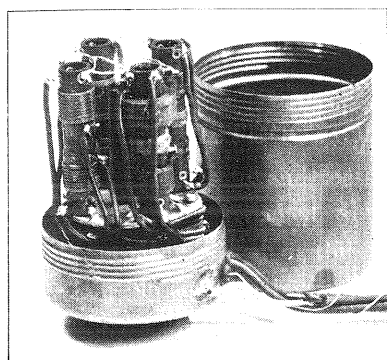

The heart of the improved test oscillator is the shielded coil and switch assembly, similar to the famous RCA Victor MAGIC BRAIN. This unit includes eight coils and an eight-position rotary switch, all compactly

mounted in a drawn copper container. High effi-

ciency and low leakage give an output r-f voltage adjustable over a wide range.

DIAL

A variable vernier dial having an adjustable ratio of from 6:1 to 20:1 speed reduction is used to facilitate tuning. The dial reads directly in frequency, no curves normally being required.

CALIBRATION

The direct reading dial is guaranteed accurate $\pm 3\%$. However, a blank card and frame on the back of the oscillator permits individual calibration when desired. Individual factory calibration is available at an additional charge of \$5.00. Such calibration covers all bands and is accurate to $\pm \frac{1}{2}$ of 1%.

CIRCUIT

A tuned grid, plate modulated circuit is used which gives good stability over a wide range of voltage and climatic conditions.

RADIOTRONS

Two RCA-30 Radiotrons are required and included with all Test Oscillators. One functions as the R.F. oscillator and the other as the A.F. modulator.

SIZE

Height, $8\frac{1}{2}$ inches (including raised handle); case alone, $6\frac{1}{2}$ inches; width, $9\frac{3}{4}$ inches; depth, $4\frac{1}{2}$ inches.

WEIGHT

Five pounds, including batteries.

CASE

The entire oscillator is enclosed in a black crinkle finish lacquered aluminum case provided with a leather handle.

ORDER FROM YOUR RCA PARTS DISTRIBUTOR

RCA PARTS  **DIVISION**

RCA MANUFACTURING CO., INC., CAMDEN, NEW JERSEY, U. S. A.



Universal Power Transformers

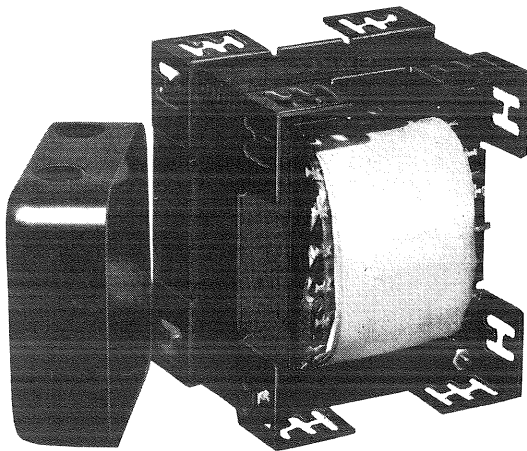

No longer is it necessary to "send away" for transformers for any make of radio receiver. RCA Universal Transformers for *all* makes of radio receivers from 1927 to 1937 have been perfected . . . even anticipating future receiver design.

Specifications

Slotted in every conceivable position for quick attachment anywhere, "H" type holes are provided in the mounting lugs differently spaced on opposite surfaces to allow maximum flexibility in mounting. Only four types are needed for the large 12-tube jobs down to the 4-tube midgets. RCA Universal Transformers present the solution to one of the Service Engineer's most annoying problems.

Terminals are provided to allow ample flexibility for adapting the transformer to any receiver circuit. Plenty of windings are available to meet the requirements of any circuit. RCA Universal Transformers in four types fit all sets from 1927 to 1937.

<p>Stock No. 9551</p> <p>List Price, \$6.00</p>	<p>FOR 10-12-TUBE SETS</p> <p>PRIMARY 115 VOLTS A.C. 50/60 CYCLES</p> <p>1 115 25 125 125 25 125 375 375</p> <p>105 AMPS. 50 AMPS. 35 AMPS. 30 AMPS. 110 AMPS. D.C. FIL #4 FIL #3 FIL #2 FIL #1 PLATE</p>
<p>Stock No. 9552</p> <p>List Price, \$6.50</p>	<p>FOR ALL CLASS B SETS</p> <p>PRIMARY 115 VOLTS A.C. 50/60 CYCLES</p> <p>1 115 25 125 125 25 125 165 30 165</p> <p>725 AMPS. 50 AMPS. 35 AMPS. 30 AMPS. 115 AMPS. D.C. FIL #4 FIL #3 FIL #2 FIL #1 PLATE</p>
<p>Stock No. 9553</p> <p>List Price, \$4.75</p>	<p>FOR 5-9-TUBE SETS</p> <p>PRIMARY 115 VOLTS A.C. 50/60 CYCLES</p> <p>10 115 25 125 125 25 125 335 335</p> <p>15 AMPS. 5 AMPS. 3 AMPS. 080 AMPS. D.C. FIL #3 FIL #2 FIL #1 PLATE</p>
<p>Stock No. 9556</p> <p>List Price, \$2.06</p>	<p>FOR 4-TUBE SETS</p>

4 1/16 3/16
2 7/16 3/16 2 7/16
2 7/16 3/16 4 7/16

MAXIMUM SIZE SCREW NUMBER B

DIMENSIONS				
Transformer Stock No.	A	B	C	D
9551	1 1/8	2 1/4	3 1/4	4 1/4
9552	1 1/8	2 1/4	3 1/4	4 1/4
9553	1 1/8	2 1/4	3 1/4	4 1/4

Dimensions in diagram same for all three models.

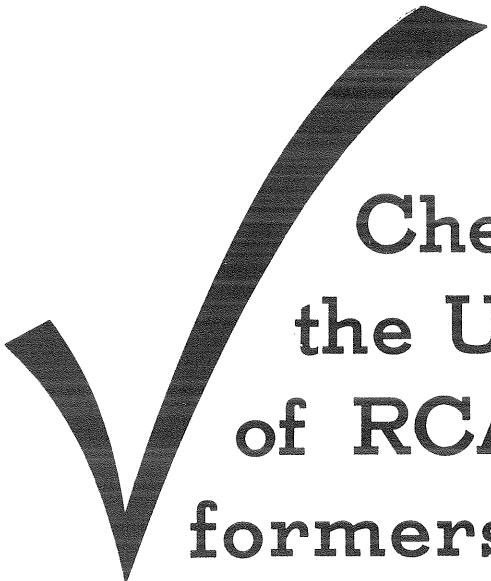

Check and Triple Check the Uniform High Quality of RCA Universal Trans- formers » » » » »

THE old adage, "You can't tell what a book contains by looking at its covers," applies with equal force to Universal Transformers. No Service Engineer can tell how a transformer has been constructed by looking at it, nor can he tell how accurately it has been tested and checked.

In preparing to manufacture and market a Universal Transformer, RCA determined that the Universal Transformer must in every way square itself with the RCA reputation for high quality parts and replacements. It must be able to "take it" under any and all service conditions that might arise. And the RCA Universal Transformer can.

In the RCA production, line testing and inspection is the order of the day. Primary windings are checked for shorted turns. The high voltage plate is tested for center-tap and the total windings for shorted turns. Each separate filament winding is tested for shorted turns. All this testing is done before any of the component units are assembled.

Next comes impregnation. The primary and high voltage windings are heated

to the temperature of the bath before immersion to assure uniform penetration. Impregnation is accomplished in vacuum tanks which remove air and moisture from the insulation and seal it.

The units are then assembled and tests are made for voltage ratio between primary and all other windings before the core is installed. The core is then applied and tests are made for core loss and exciting current.

At this stage of production every single part has been tested separately and then collectively.

After final assembly of all the parts, the transformers are tested all over again for primary watts input and primary exciting current. And then they are tested again—this time automatically on a traveling test belt, with all possibilities of human error removed—under conditions more severe than ever developed in actual service.

Transformers that meet the exacting specifications of each of these many tests and inspections are considered worthy of the RCA name and are sold with the RCA guarantee.



OUTPUT INDICATOR

Stock No. 4317

No Longer Need You
"Peak" Receivers by Ear.
Get an RCA Output
Indicator

- High Sensitivity
- No burn-outs in normal use
- Has three impedances
- Use it on any receiver
- Sturdy and foolproof
- No delicate parts
- For use with any oscillator
- Attractive bakelite case

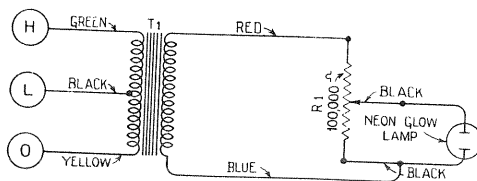
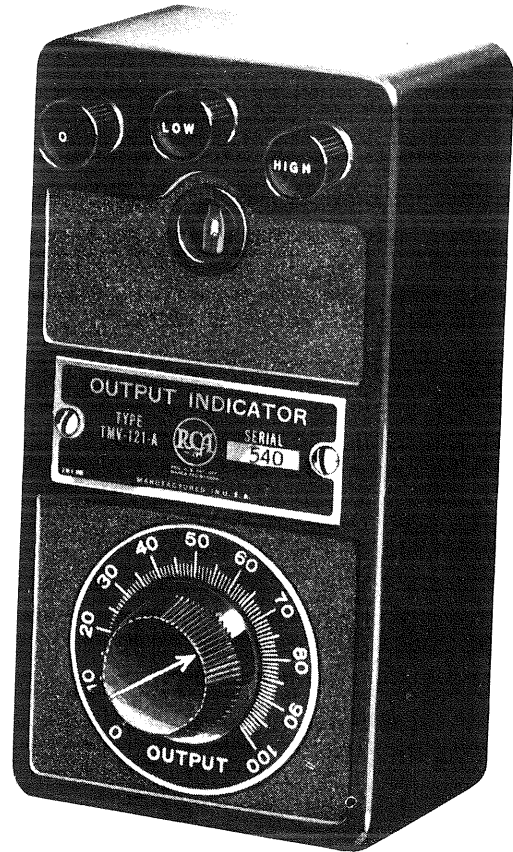

The RCA Output Indicator is a small, compact, visual output indicator designed for use with an oscillator when aligning radio receivers. The instrument consists of a tapped step-up transformer, a potentiometer, a glow tube and three binding posts for connecting the output of the receiver to the transformer. Three input impedances are available, namely, 0.6 ohm, 1.5 ohms and 4 ohms, which cover practically all receivers manufactured.

The instrument is used by connecting it across the leads of the input to the voice coil of the loudspeaker. The speaker may or may not be connected, as desired by the user. So connected, the glow tube will glow when a signal is impressed on the output indicator. The glow of this lamp is very sensitive, following variations in frequency and intensity. Naturally, this provides a very sensitive indicator for adjusting trimmer capacitors to their optimum position.

The entire mechanism is housed in an attractive die-cast bakelite case.

SPECIFICATIONS

- Dimensions - 5 3/8" x 2 7/8" x 2 3/8"
- Weight - - - - 13 Ounces
- Case - Die-cast moulded bakelite
- Lamp Rating 50-60 volts breakdown
- Transformer Rating 80:1 (maximum)
- Input Impedances 0 to H, 4 ohms,
0 to L, 1 1/2 ohms, H to L, .6 ohm
- Potentiometer Resistance
100,000 ohms

NET PRICE \$4.00

You can save *time* and *money*

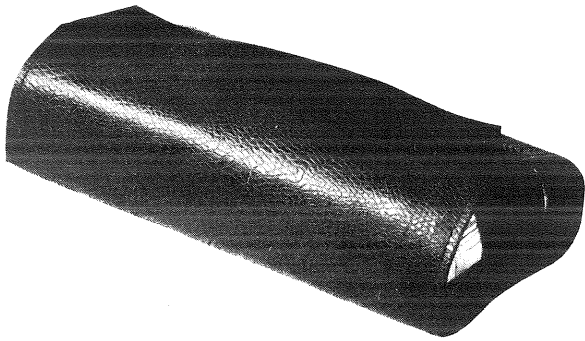

RCA Cabinet Refinishing Kit

YOU won't call in the cabinet refinisher nearly so often after you get the RCA Cabinet Refinishing Kit. Of course you can't do every refinishing job with it, but you can do most of them—saving time and money on every job. It's the little touch-up jobs that occur most often any-

- | | |
|---|-----------------------------|
| 1 | Can Refco Oil |
| 1 | Can Valvoline |
| 1 | Can Tripoli |
| 1 | Assortment Sand Paper |
| 1 | Assortment Stick Shellac |
| 2 | Pkgs. Aniline Stain Powders |
| 1 | Touch-up Brush |
| 1 | Spatula |
| 1 | Rubbing Block |
| 1 | Instruction Sheet |

how. Someone in the shop lays a hammer on the cabinet; a button on the truck driver's coat scratches it in delivery; or perhaps it has been marred in home demonstrations or while on display in the dealer's store. But whatever the cause, you have the remedy at hand for use.



The RCA Cabinet Refinishing Kit does not contain all the material you will need for every job. For example, it does not contain lacquer, or a lamp for heating the spatula. But things like that are obtainable anywhere. Only the hard-to-obtain things have been included; the items you would have to run all over town to get, if obtainable at all.

Packed in a durable leatherette case, measuring $9\frac{1}{2}'' \times 4\frac{1}{2}'' \times 2\frac{1}{4}''$, it opens like a purse. Stock No. 9546. Net to Service Engineers \$2.90.

ORDER FROM YOUR RCA PARTS DISTRIBUTOR

Modernizing Phonographs

The
1935 Money-Maker

for
Service Engineers

▼
RCA Phonograph
Modernization Kits

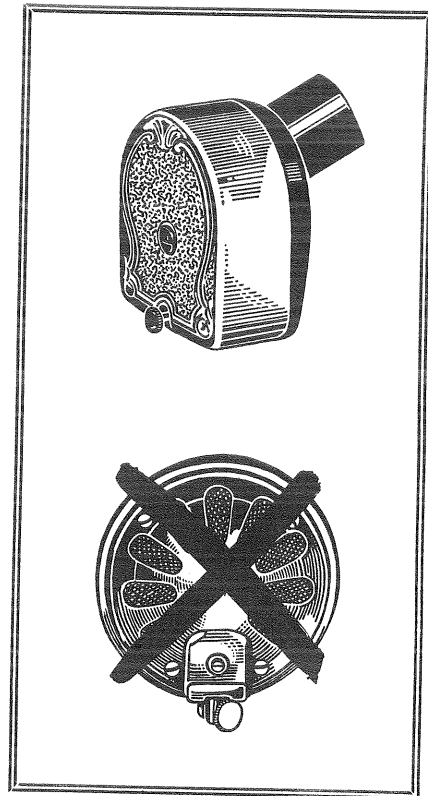

THE phonograph is coming back into its own. The amazing technical perfection of "Higher Fidelity" Recording has revitalized interest in recorded music. The introduction of low-priced Bluebird Records has brought recorded music within the reach of all.

Old Victrolas, talking machines of all descriptions are being modernized by alert

Service Engineers, who realize a handsome profit from every sale.

The modernization of phonographs is the Service Engineer's job, his opportunity for 1935. He alone in the entire industry gets into the home under conditions favorable to the promotion of this new and profitable phase of home entertainment.

PACKAGE		CONTENTS							
Stock No.	List Price	Pickup Arm With Escutcheon		Pickup		Volume Control		Input Trans.	
		No.	Type	No.	Impedances	No.	Resistance	No.	Works Into
11099	\$12.10	10779	Straight	10781	200	10795	500	10414	RCA-26
11075	10.80	8858	Straight	7394	20	6225	60	7445	General
11076	10.54	11102	Inertia	6474	700	6475	5000	None	RCA-57
11080	13.10	11091	Inertia	6335	7	6355	200000	7529	RCA-56
11100	5.85	6592	Midget	6592	2450	6590	5000	None	RCA-77

To make his work easy; to simplify his purchases of parts, the kits described on this and the next page are presented and are available at RCA Parts Distributors. Write to RCA Parts Division, Camden, N. J.; for booklet, "Phonograph Modernization."

ORDER FROM YOUR RCA PARTS DISTRIBUTOR

RCA Phonograph Modernization Kits

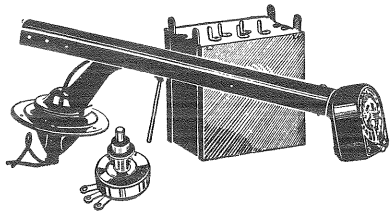

RCA
Phonograph Modernization Kit
Stock No. 11099

Contents: 200-ohm Pickup, Straight Type Pickup Arm, 500-ohm Volume Control, and Input Transformer. List price, \$12.10.

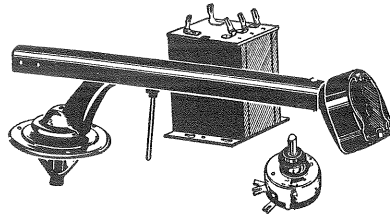

RCA Phono-
graph Modern-
ization Kit
Stock No. 11075

Contents: 20-ohm Pickup, Straight Type Pickup Arm, 60-ohm Volume Control, and Input Transformer. List price, \$10.80.

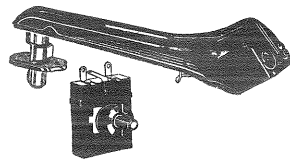

RCA
Phonograph Modernization Kit
Stock No. 11100

Contents: A 2450-ohm Midget Pickup and 5000-ohm Volume Control. For inexpensive installations where space is limited. Usually used with Stock No. 9038 Motor, shown directly below at right. List price, \$5.85.

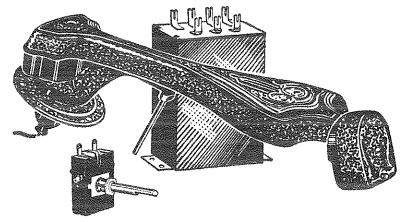

RCA
Phonograph Modernization Kit
Stock No. 11080

Contents: 7-ohm Pickup, Inertia Type Pickup Arm, 20,000-ohm Volume Control, and Input Transformer. List price, \$13.10.

Stock No. 3599

MOTOR MOUNTING ASSEMBLY (not illustrated), comprising one screw, one washer and one lock washer. This unit contains the three sets necessary for mounting the Stock No. 8989 Motor on the motor board. List price, \$.30.

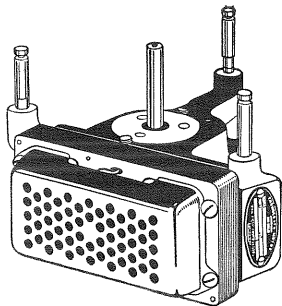

Stock No. 8989

MOTOR complete, for 60 cycles, 115 volts. This is the same sturdy motor used in the highest quality of phonographs and combinations made by the RCA Victor Company. List price, \$18.52.

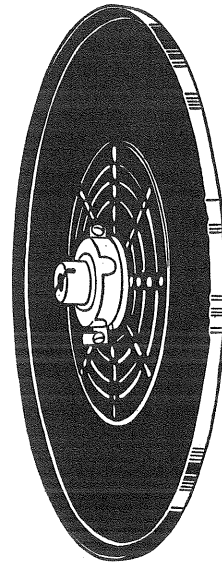

Stock No. 8948

TWO SPEED TURNTABLE. Fits shaft of Stock No. 8989 Motor (shown above). This turntable adds distinction to your work and gives it the stamp of modern workmanship. It is the same turntable used in RCA Victor Combinations to play both standard (78 R.P.M.) and long-playing (33½ R.P.M.) recordings. List price, \$5.50.

Stock No. 3813

MOTOR MOUNTING ASSEMBLY (not illustrated), comprising one metal bushing, two rubber bushings, one flat washer, one lock washer and one nut. Three sets required to mount Stock No. 9038 Motor (above). List price, 3 sets, \$1.68.

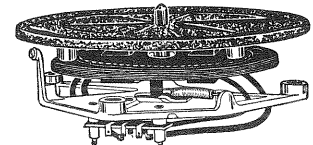

Stock No. 9038

SYNCHRONOUS TYPE MOTOR WITH TURNTABLE—115 volts, 60 cycles. Although this motor is not self-starting, it serves the purpose admirably where cost is a factor. Where space is limited this unit fits in easily. Plays either 10 or 12-inch records at standard speed. List price, \$8.00.

This is the sturdy motor and turntable used in the RCA Victor Record Player. Its small size, light weight and low price make it ideal for portable equipment or for permanent installations in which either cost or space is the main consideration.

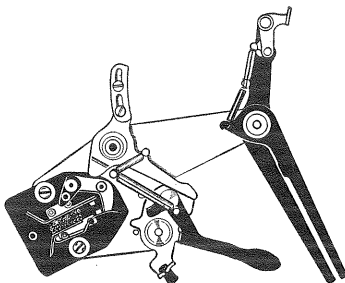

Stock No. 3391

MOTOR BOARD SUSPENSION SPRING ASSEMBLY (not illustrated), comprising 1 bolt, 1 top spring, 1 bottom spring, 2 cap washers, 1 C washer and 1 nut. Recommended for mounting a motor board for Stock No. 8989 in a cabinet. Specially tuned springs prevent vibration being transmitted mechanically to the pickup and spoiling reproduction. Four sets required. List price, 4 sets, \$2.00.

Stock No. 7180
AUTOMATIC ECCENTRIC BRAKE (left) to stop the turntable at the end of a record having an eccentric groove. To be used with Kits Nos. 11099 and 11075 (Pickup arms of the "straight type"). List price, \$2.60.



Stock No. 11106

The **SHIFT LEVER** used to change the speed of the turntable (8948) from standard to long playing. Not included with 8948. List price, \$.98.

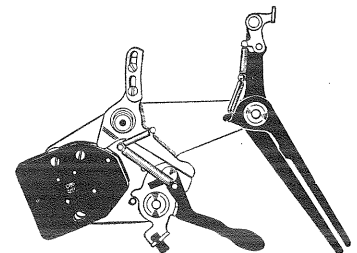

Stock No. 6896

AUTOMATIC ECCENTRIC BRAKE to stop turntable at end of record having an eccentric groove. To be used with Kits Nos. 11075 and 11099 (Pickup arms of the inertia type). List price, \$2.50.

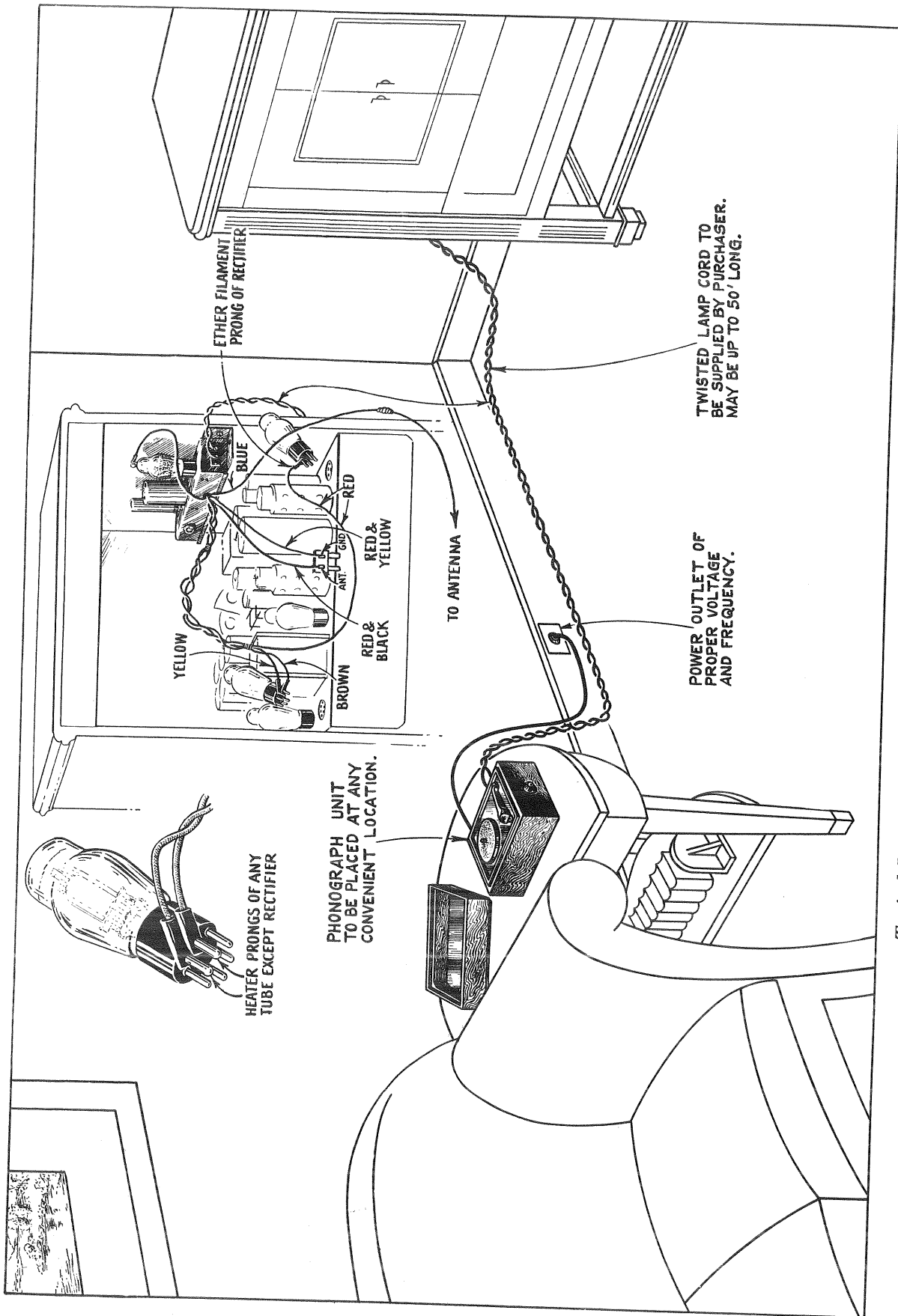

Typical Installation of R-93 and RK-24 Phonograph Oscillator

A miniature *Broadcast Station* for every receiver...profits for Service Engineers!

SHOW YOUR customers how to broadcast records to themselves with the RCA Phonograph Oscillator. Possessing all the appeal of a distinct novelty, but with RCA practicability and durability built in, the RCA Phonograph Oscillator will prove popular with Service Engineers and receiver owners.



RCA Phonograph Oscillator

For the Service Engineer: For the Service Man the RCA Phonograph Oscillator does two things. It makes additional profits for him through the sale of additional equipment and solves one of his toughest problems in phonograph modernization work. The output from the pickup coil modulates the oscillator which is coupled to the antenna of the receiver. This modulated signal is tuned in on the receiver just like any broadcasting station.

Only a few minutes are required to attach the RCA Phonograph Oscillator. No struggle is involved to get the grid bias right; no circuit changes to make; no impedance matching. Just a few simple connections are necessary, for which directions are supplied with the equipment.

For the Receiver Owner: The RCA Phonograph Oscillator provides a miniature broadcasting station for every receiver-owning home. Its fidelity of record reproduction is limited only by the qualities of the receiver to which it is attached. It enables the owner to hear his favorite artists whenever he wants and as often.

With the rapidly reviving interest in record reproduction, and low-priced Bluebird records now within the reach of all, a tremendous field for profits awaits the alert Service Man.

This unit presents one more RCA profit maker for Service Engineers—one more trouble saver. Watch for the announcements of new, interesting, money - making, labor - saving devices that RCA Parts Division Engineers are developing now. Keep in touch with your RCA Parts Distributor.

Stock No. 9554, List Price, (without tube) \$7.75

ORDER FROM YOUR RCA PARTS DISTRIBUTOR

Here's more about that money-making Oscillator RK-24

THE RK-24 Phonograph Oscillator is a small broadcast band oscillator unit designed for use with the RCA Victor Record Player (Model R-93), it may be attached to radio sets of all kinds and types. In addition to its primary use with the R-93, it may be used also for attaching any type of magnetic pickup to any type of receiver with slight modifications (usually the inclusion of an input transformer).

The primary purpose of the RK-24 Phonograph Oscillator is to insure proper phonograph reproduction within the limits of the receiver in all cases, avoiding the necessity of any circuit changes. No longer is the Service Engineer worried with the problems involved in overcoming avoidance of hum, distortion in the audio system and other factors that invariably occur.

FOOL-PROOF CONSTRUCTION

The unit is of simple design and fool-proof construction, and may be attached to practically any set by one unskilled in the art of radio service. Suitable leads with special contacts are provided for obtaining filament and plate power for the oscillator unit, so that internal wiring to the chassis is not necessary.

Of unusual interest is its ability, through the use of the RCA-6A7 or 2A7 tubes, to be used with receivers having either 2.5-volt heater type tubes or 6.3-volt heater type tubes. *For this reason it is sold without tube.* This adaptability makes it possible to operate the RK-24 Oscillator with practically all radio sets of the AC type manufactured during the last five years.

A TRANSMITTING STATION

The RK-24 is actually a miniature transmitting station, modulated with the output of the phonograph pickup. As the frequency range of the pickup is usually equal to or better than the transmission range of the ordinary

broadcasting station and there is no intervening factor such as fading and distortion due to transmission, the phonograph quality will, in practically all cases, be that obtained with the very best possible local broadcasting stations to which the receiver may be tuned.

For this reason, one will know in advance that the phonograph reproduction quality will be limited only by the capabilities of the receiver to which it is attached

The simplicity of connections is such that it usually takes about five minutes to install.

A TRANSFERABLE UNIT

The RK-24 may be removed from one receiver to another very quickly and easily. Optimum results will be obtained in all cases. Avoidance of any switching requirements in the radio chassis proper, as well as any circuit changes, such as changing of detector tube bias to operate them as audio amplifiers and lack of sufficient audio gain, are all eliminated through the use of the RK-24 Oscillator.

We believe this oscillator fills a long-felt need often expressed by service men modernizing old phonographs, or service men attaching electric phonographs to ordinary radio sets. It also opens up a new field due to the simplicity of its connections, and the assured results obtained.

ELECTRICAL SPECIFICATIONS

Tuning Range.....	1400-1700 Kilocycles
Type of Oscillator Circuit...	Hartley Oscillator
Type of Modulation	Suppressor Grid Modulation
Input Voltage	0.3 Volt
Output Impedance.....	30 Ohms
Heater Current	1.0 Ampere (2.5 V.), 0.3 Ampere (6.3 V.)
Plate Current...	2.0 Milliampere at 250 Volts

All RCA Victor Service Notes

... Now in Six Bound Volumes

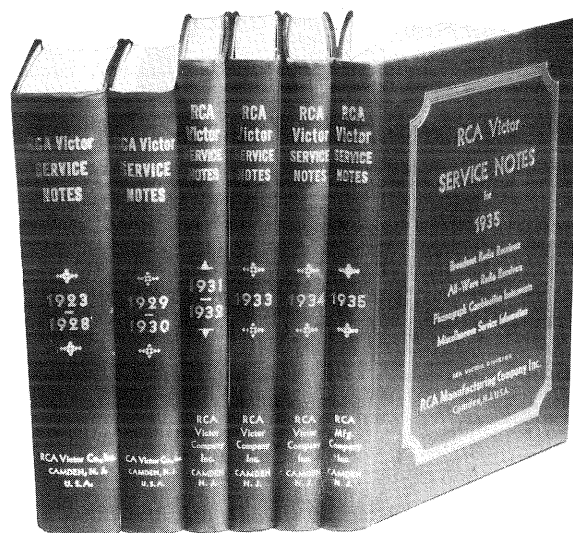

This library contains complete service information, drawings and price lists 1923-1935

SO immediate was the acceptance of the bound volumes of RCA Victor Service Notes for 1931-32 and 1933; so strong was the demand that four more volumes have been compiled. There are now six bound volumes included in the RCA Victor Service Library.

The six volumes cover all RCA or Victor models produced from 1923 to 1936 except old Victrola instruments that did *not* contain a radio receiver. Complete replacement parts lists are provided for all models issued since 1929.

When the Service Engineer wants technical information on any RCA Victor model, he turns to the index of his bound volume; a moment later diagrams, parts lists and prices and service notes are lying *flat* on the table before him.

Service Engineers who use the volumes regard them as their "Business Bible," not alone for the diagrams and drawings but for the time saving service information, conveniently arranged for every RCA Victor receiver. Schematic drawings can be obtained elsewhere, but the technical information is not so readily found.

In addition, each volume will contain other valuable information such as impedance, inductance and capacity charts, and other data peculiar to the receivers described therein.

A limited edition is being published and to make sure of copies for yourself, we suggest that you place your order now.

★ NET PRICE ★
\$1⁰⁰ PER VOLUME

F. O. B. CAMDEN, N. J.

ORDER FROM YOUR RCA PARTS DISTRIBUTOR

CONTENTS

1923-28

<p>INSTRUCTIONS AND CIRCUIT DIAGRAMS</p> <p>RCA Radiola AR (Radio Frequency Amplifier)</p> <p>RCA Radiola RT (Antenna Coupler)</p> <p>RCA Radiola RC Schematic Diagram and Battery Connections</p> <p>RCA Aeriola, Sr., Schematic Diagram</p> <p>RCA Radiola RS (Regenerative Receiver and Amplifier)</p> <p>RCA Radiola AC (2-Stage Audio Amplifier)</p> <p>RCA Radiola, Sr., and Type AC Amplifier Schematic Diagram and Battery Connections</p> <p>RCA Radiola RS and Balanced Amplifier Schematic Diagram and Battery Connections</p> <p>Model AR-1300 Radio Receiver</p> <p>Model AA-1400 Detector Amplifier</p>	<p>Model AA-1520 Radio Frequency Amplifier</p> <p>RCA Radiola II</p> <p>RCA Radiola III</p> <p>RCA Radiola III-A</p> <p>RCA Radiola Balanced Amplifier</p> <p>Radiolas III, III-A and Balanced Amplifier Using Radiotrons UX-199 and UX-120</p> <p>RCA Radiola IV</p> <p>RCA Radiola V</p> <p>RCA Radiola VI</p> <p>RCA Radiola VII</p> <p>RCA Radiola VII-B</p> <p>RCA Radiola Super-VIII</p> <p>Use of UR-556 Adaptor</p> <p>RCA Radiola IX</p> <p>RCA Radiola X</p> <p>RCA Radiola Regenoflex</p> <p>RCA Radiola Grand</p> <p>BATTERY CONNECTIONS</p> <p>RCA Radiola Super-Heterodyne (Semi-Portable) Battery Connections</p>	<p>RCA Radiola 20 Battery Connections</p> <p>RCA Radiola 24 Battery Connections</p> <p>RCA Radiola 25 Battery Connections</p> <p>RCA Radiola 26 Battery Connections</p> <p>RCA Radiola 28 Battery Connections</p> <p>RCA RADIOLA AND LOUDSPEAKER SERVICE NOTES</p> <p>RCA Radiola 16</p> <p>RCA Radiola 17</p> <p>RCA Radiola 18</p> <p>RCA Radiolas 18 D. C. and 51 D. C.</p> <p>RCA Radiola 20</p> <p>RCA Radiola 25</p> <p>RCA Radiolas 25 and 28 A. C.</p> <p>RCA Radiolas 26, 24 Super-Heterodyne and Super VIII</p> <p>RCA Radiola 28</p> <p>RCA Radiola 30</p>	<p>RCA Radiola 30-A</p> <p>RCA Radiolas 30-A D. C., 32 D. C. and 104 D. C.</p> <p>RCA Radiola 32</p> <p>RCA Radiola 41</p> <p>RCA Radiola 41 D. C.</p> <p>RCA Loudspeaker 100</p> <p>RCA Loudspeaker 100-A</p> <p>RCA Loudspeaker 103</p> <p>RCA Loudspeaker 104</p> <p>RCA Loudspeaker 105</p> <p>RCA Loudspeaker 106</p> <p>RCA Power Amplifier AP-935</p> <p>RCA "B" Battery Eliminator AP-937</p> <p>Use of "B" Eliminator with Super VIII</p> <p>RCA "B" Eliminator AP-1080</p> <p>RCA Short-Wave Receiver AR-1145</p> <p>VICTOR RADIO RECEIVER AND ELECTROLA SERVICE NOTES</p> <p>Victor Model 7-1 (Alhambra I)</p>	<p>Victor Model 7-2 (Alhambra II) and 9-1 (Florenza)</p> <p>Victor Model 7-3 and 7-30</p> <p>Victor Model 7-10</p> <p>Victor Model 7-11 and 7-26</p> <p>Victor Model VE-8-60</p> <p>Victor Model 9-2 (Borgia II)</p> <p>Victor Model 9-3 (Borgia I)</p> <p>Victor Model 9-15</p> <p>Victor Model 9-16</p> <p>Victor Model 9-18</p> <p>Victor Model 9-25</p> <p>Victor Model 9-40 (Borgia)</p> <p>Victor Models 9-54 and 9-56</p> <p>Victor Model 9-55</p> <p>Victor Model 10-51</p> <p>Victor Model 10-69</p> <p>Victor Model 10-70</p> <p>Victor Model 12-1 (Cromwell)</p> <p>Victor Model 12-2 (Tuscany)</p> <p>Victor Model 12-15</p> <p>Victor Model 12-25</p> <p>Victor Model 15-1 (Hyperion)</p> <p>Victor Model 10-35</p> <p>Victor Model E-35</p>
--	---	--	--	---

1929-30

<p>RCA RADIOLAS AND LOUDSPEAKERS</p> <p>RCA Radiolas 21 and 22</p> <p>RCA Radiola 33</p> <p>RCA Radiola 33 D. C. (110 Volt)</p> <p>RCA Radiola 33 D. C. (220 Volt)</p>	<p>RCA Radiola 42 (also Victor Radio R-14)</p> <p>RCA Radiolas 44 and 46</p> <p>RCA Radiola 46 D. C. (110 Volt)</p> <p>RCA Radiola 47</p> <p>RCA Radiola 48 (also Victor Radio R-15)</p>	<p>RCA Radiola 60</p> <p>RCA Radiola 62</p> <p>RCA Radiola 64</p> <p>RCA Radiola 66</p> <p>RCA Radiola 67</p> <p>RCA Radiolas 80 and 82</p> <p>RCA Radiola 86</p>	<p>RCA Radiolas 82 and 86 (Remote Control)</p> <p>RCA Radiola Short-Wave Adaptor</p> <p>RCA Theremin</p> <p>RCA Loudspeaker 100-B</p> <p>RCA Power Amplifier AZ-774-B</p>	<p>RCA Magnetic Pickup AZ-1604</p> <p>VICTOR RECEIVERS</p> <p>Models R-32, RE-45, R-52 and RE-75</p> <p>Models R-35, R-39, RE-57</p> <p>Model RE-17</p>
---	--	---	---	--

1931-32

<p>RCA World-Wide Antenna System</p> <p>RCA Victor Shield Kits</p> <p>Frequency, Impedance, Inductance and Capacity Chart</p> <p>RCA Full-Range Test Oscillator</p> <p>RCA Tools and Accessories</p> <p>Radiotron Data Sheets</p> <p>SR-1, SR-2, and SR-3 (Two-Speed Turntables)</p>	<p>MB-1, MB-2, and MB-3 (Replacement Motor Boards)</p> <p>2-25</p> <p>2-65</p> <p>SWA-2</p> <p>R-4 and R-6</p> <p>R-5</p> <p>R-5X</p> <p>R-5 D. C.</p> <p>T-5</p> <p>R-7 (Superette)</p>	<p>R-7A</p> <p>R-7 L. W.</p> <p>R-7 D. C. and R-9 D. C.</p> <p>SK-7</p> <p>R-8 and R-12</p> <p>R-8 D. C. (220-volt)</p> <p>R-10</p> <p>R-10 D. C.</p> <p>R-11</p> <p>R-11 Supplement</p> <p>RE-16</p> <p>RE-16A</p>	<p>RE-18</p> <p>RE-18A</p> <p>RE-19</p> <p>RE-20</p> <p>R-21</p> <p>RO-23</p> <p>RAE-26</p> <p>CE-29</p> <p>M-30</p> <p>P-31</p> <p>M-32</p>	<p>PT-33</p> <p>R-43</p> <p>R-50 and R-55</p> <p>RAE-59</p> <p>RAE-68</p> <p>R-70</p> <p>RE-73</p> <p>R-74, R-76, and R-77</p> <p>RAE-79</p> <p>Automatic Record Changing Mechanism</p> <p>Special Service Information</p>
--	--	---	--	--

1933

<p>All Wave Reception Reception Chart</p> <p>Antenna Length Chart</p> <p>Predicting Reception</p> <p>Magnetic Activity Chart</p> <p>RCA World Wide Antenna System</p> <p>RCA Victor Shield Kits</p> <p>Frequency, Impedance, Inductance and Capacity Chart</p> <p>RCA Test Oscillator</p> <p>RCA Tools</p> <p>Replacement Vibrator</p> <p>Dealers Kits</p>	<p>Radiotron Data Station List</p> <p>R-3B</p> <p>R-3C</p> <p>SW-3</p> <p>CRD-9 D.C.</p> <p>CRD-9 A.C.</p> <p>R-17-M</p> <p>R-18-W</p> <p>R-22</p> <p>R-25 D.C.</p> <p>R-27</p> <p>R-27 (Revised)</p> <p>R-28</p>	<p>R-28 BW</p> <p>R-28 BWC</p> <p>R-28-P</p> <p>M-34</p> <p>R-37 and R-38</p> <p>R-37-P and R-38-P</p> <p>RE-40</p> <p>RE-40-P</p> <p>R-51-B and R-53-B</p> <p>R-71 and R-72</p> <p>R-71-B</p> <p>R-73</p> <p>R-73 (Revised)</p> <p>R-75</p>	<p>R-75 (Revised)</p> <p>R-78</p> <p>RE-80</p> <p>RE-81</p> <p>RAE-84</p> <p>R-90</p> <p>R-90-P</p> <p>TMV-97-A</p> <p>100 and 101</p> <p>100 and 101 (Revised)</p> <p>110, 111 and 115</p> <p>112</p> <p>114</p> <p>120</p>	<p>121 and 122</p> <p>140, 141, 141-E, 240 and AVR-1</p> <p>140 Volume Control Replacement</p> <p>142-B and 241-B</p> <p>220 and 222</p> <p>260</p> <p>280</p> <p>300</p> <p>310</p> <p>330</p> <p>331</p>
--	---	--	--	--

1934

<p>RCA Laboratory Equipment</p> <p>RCA Standard Signal Generator Type TMV-18-D</p> <p>RCA Universal Curve Recorder Type TMV-36-B</p> <p>RCA Beat Frequency Oscillator Type TMV-52-E</p> <p>RCA Field Intensity Meter Type TMV-75-B</p> <p>RCA Regulated S.P.U. Type TMV-118-B</p> <p>RCA Tools and Accessories</p> <p>RCA Full Range Test Oscillator Type TMV-97-B</p> <p>RCA Output Indicator Type TMV-121-A</p>	<p>RCA Auto Radio Accessories</p> <p>RCA Replacement Transformers</p> <p>RCA Pickup Kits</p> <p>RCA Phonograph Oscillator</p> <p>RCA Victor Bound Volume Service Notes</p> <p>RCA Cabinet Refinishing Kit</p> <p>RCA Radiotron Data Sheets</p> <p>RCA Victor Model R-91-B</p> <p>RCA Victor Model R-92</p> <p>RCA Victor Model R-93</p> <p>RCA Victor Model 102</p> <p>RCA Victor Model M-105</p>	<p>RCA Victor Model M-107</p> <p>RCA Victor Model 112-A</p> <p>RCA Victor Model M-116</p> <p>RCA Victor Models 118 and 211</p> <p>RCA Victor Model M-123</p> <p>RCA Victor Model 124</p> <p>RCA Victor Model 126-B</p> <p>RCA Victor Model 127</p> <p>RCA Victor Models 128 and 224</p> <p>RCA Victor Models 135-B and 235-B</p> <p>RCA Victor Models 143 and 242</p>	<p>RCA Victor Models 140, 141, 141-E and 240 (with external I. F. transformers)</p> <p>RCA Victor Model 221</p> <p>RCA Victor Model 223</p> <p>RCA Victor Model 261</p> <p>RCA Victor Model 262</p> <p>RCA Victor Model 281</p> <p>RCA Victor Model 301</p> <p>RCA Victor Model 320</p> <p>RCA Victor Model 321</p> <p>RCA Victor Model 322</p> <p>RCA Victor Model 327</p>	<p>RCA Victor Models 340 and 340-E (with external I. F. transformers)</p> <p>RCA Victor Model 341</p> <p>RCA Victor Model 380</p> <p>RCA Victor Model 380-HR</p> <p>RCA Victor Model 381</p> <p>Nine-Tube General Purpose All-Wave Receiver (AVR-5A)</p> <p>RCA Full Range Test Oscillator Type TMV-97-B Instructions</p> <p>RCA World Wide Antenna Installation Instructions</p>
---	---	---	---	---



DI-POLE AUTO ANTENNA

LIST PRICE

\$2.60

STOCK No. 9605

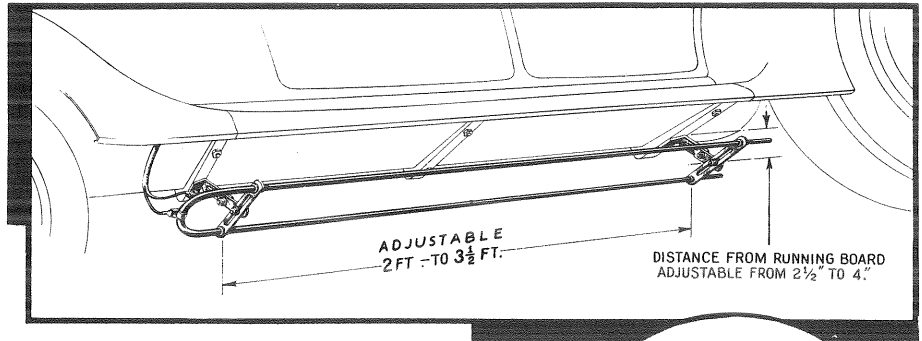

A "SET-UP"

FOR THE SERVICE ENGINEER

Steel top autos plus this new noise-reducing running board antenna means profits for you

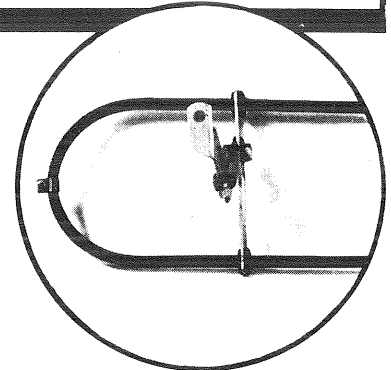

Cash in on the new steel-top automobiles without antennas. Install the new noise-reducing RCA Di-Pole Antenna on any car and guarantee improved results. As sensational in the automotive field as the famous RCA World-Wide Antenna is in the home reception field.

The new RCA Noise-Reducer Auto Antenna is an entirely new development in automobile antenna design. It's easily and quickly installed on any car, gives efficient pickup from stations, and eliminates all ignition-noise pickup by the antenna. Its low price ensures a ready sale to any automobile radio purchaser.

SPECIFICATIONS

OPERATING PRINCIPLE

Signals are picked up by the antenna acting as a counterpoise and the car acting as an antenna. Decreasing the distance from the antenna to the road increases signal pickup. Noise from nearby sources such as ignition interference is eliminated by cancellation effects caused by the shape of the antenna.

CONNECTIONS

A machine screw at the center of the bend in the rod is provided for attaching the shielded antenna lead from the receiver.

MOUNTING

Two universal type brackets are provided for attaching to the running board by means of the bolts normally used on the car. The height of the antenna may be quickly adjusted by the brackets to insure road clearance.

ORDER FROM YOUR RCA PARTS DISTRIBUTOR

UNIMPRINTED—50 Copies Free to All RCA Parts Distributors
ADDITIONAL UNIMPRINTED COPIES—25 Cents per 100
YOUR 3-LINE IMPRINT HERE—100 Copies—50 Cents
Each Additional 100 Copies—35 Cents • ALL COPIES POSTPAID

Again... RCA LEADS

WITH THE NEW ...



UNIVERSAL A. C. BRIDGE

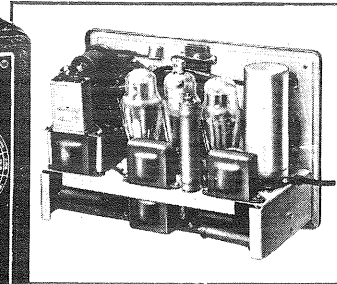
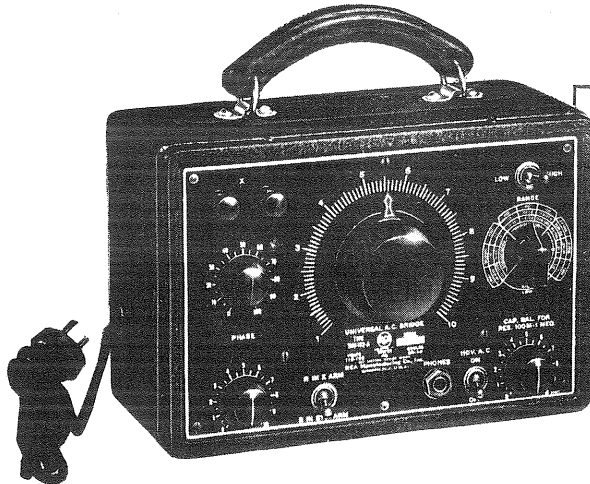

STOCK NO. 9600

NET PRICE
\$49.65

COMPLETE
 With All Tubes and Standards

Speed up your work with this new RCA Universal Bridge. You can make accurate measurements (at 1,000 CPS) of the three basic properties of all electrical devices—inductance, capacity and resistance—quickly and easily. Has built-in precision standards.

MEASURES

- INDUCTANCE . . . 100 Microhenries to 10 Henries
- CAPACITY . . 10 Micro-microfarads to 10 Microfarads
- RESISTANCE 1 Ohm to 1 Megohm

Accuracy . . . 5% Overall at Full Scale

for
 SERVICE
 ENGINEERS
 •
 EXPERIMENTERS
 •
 LABORATORY
 WORKERS
 •
 MANUFACTURERS

The new RCA Universal Bridge is the latest item of Test Equipment offered by the RCA Parts Division for the simplification and quick analysis of service or laboratory problems. This bridge gives a quick and accurate check of inductance, capacity and resistance over extremely wide ranges. These ranges include the low values that ordinary resistance and capacity meters do not check. The only additional equipment needed is a headphone for use as a null indicator.

While many laboratories are able to make measurements of inductance, resistance and capacitance, very few are permanently set up to cover the extremely wide ranges of the RCA Universal Bridge. A small portable bridge, having such wide ranges with built-in standards, is an extremely useful piece of apparatus, regardless of other equipment available.

In the Service Field, the necessity for making measurements of inductance, capacity and resistance arises every day. The addition of the RCA Universal Bridge to a service engineer's equipment lessens his work and increases the accuracy of observations.

THEORY OF OPERATION

The Wheatstone Bridge is a device whereby the value of an unknown resistor, capacitor or inductor may be measured by comparison with known standards. A bridge operates on the principle of a balanced parallel impedance network, measurements being obtained through the use of known standards and ratios.

The diagram shows a parallel impedance network whereby an unknown may be connected in series with a known standard and a variable ratio arm A connected in series with a fixed arm B. A source of 1,000-cycle A.C. is connected at points C and D, while a headphone is connected to points E and F to indicate a balance. Such a balance is indicated when no sound is heard in the telephones, this indicating that the ratio of arm A to B is identical with that of the unknown to the standard. By calibrating the dial of variable arm A, the value of the unknown may be read directly from the dial. By properly choosing

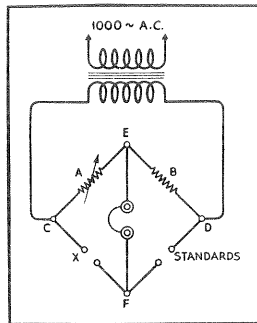

the value of the standards, the various ranges are multiples of the basic range of 1 to 10.

Working on the principle of impedance and using an A.C. source of voltage for obtaining a balance, the bridge is equally adaptable to measuring resistance, capacity and inductance. However, it should be noted that resistance measurements are accurate only when no inductance is present in the circuit, as the bridge has no means of distinguishing any of the components of impedance. *Therefore, it is not suitable for measurement of the D.C. resistance of coil windings.*

Another important property of a bridge is that as the ratios increase there is less voltage present for operating the null indicator (headphones). To overcome this, a two-stage audio amplifier, tuned to 1,000 cycles, is provided to increase this voltage to a suitable value for any balance.

ORDER FROM YOUR RCA PARTS DISTRIBUTOR



RCA PARTS DIVISION

RCA MANUFACTURING CO., Inc., CAMDEN, NEW JERSEY, U. S. A.

A Radio Corporation of America Subsidiary

Complete . . . Portable . . . A-C Operated!



CATHODE RAY OSCILLOGRAPH

Stock No. 9545

\$84⁵⁰ *With RCA Tubes, Including
RCA-906 Cathode Ray Tube*

Complete . . .

The RCA Cathode Ray Oscillograph Type TMV-122-B, is complete in every essential requirement for immediate use. It includes two power supplies (one for the Cathode Ray Tube and one for the amplifier), vertical and horizontal amplifiers, saw-tooth frequency generator and six tubes, including the RCA-906 Cathode Ray Tube (3-inch).

2 Volts per Inch . . .

Through the use of two wide-frequency-range high-gain amplifiers, the sensitivity is guaranteed at 2 volts D. C. per inch for both vertical and horizontal deflection. The amplifiers have flat frequency characteristics between 20 and 90,000 cycles \pm 10 per cent. The amplifier gain is approximately 40.

20-15,000 Cycles . . .

A linear saw-tooth timing frequency oscillator with a special synchronizing circuit is an integral part of the RCA Oscillograph. The frequency range extends from 20 to 15,000 cycles and permits the examination of a single cycle up to 15,000 cycles or the examination of six cycles up to the limit of the amplifier—90,000 cycles. Suitable switching is provided so that either the internal timing oscillator or an external source of frequency may be connected to the plates through the amplifier. The binding posts may be connected directly to the plates for operation above 90,000 cycles with a sensitivity of 75 volts per inch.

Beam Centering . . .

Two screwdriver adjustments are provided for centering the beam on the fluorescent screen. This may be required because of changes in geographical location or variations in tubes and circuit constants.

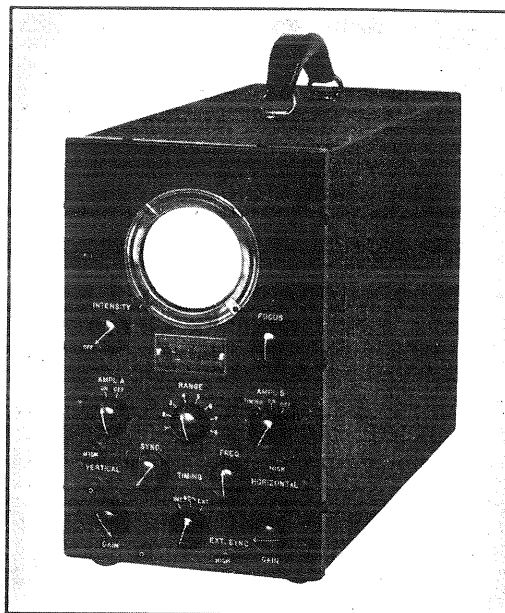

● For Service Engineers

Visual alignment of tuned circuits, "flat-topping" I. F. circuits, measuring hum and checking distortion in audio amplifiers are but few of the problems which are easily solved through the use of the RCA Cathode Ray Oscillograph. A visual presentation of practically all alternating current circuit functions may be quickly and easily made.

● For Amateurs and Experimenters

The RCA Cathode Ray Oscillograph enables the amateur to monitor percentage modulation, to check modulated waveform for distortion and examine the phase shift in audio amplifiers. Through its use the experimenter may easily and quickly arrive at the solution of the most difficult problem.

● For High Schools and Universities

Now every high school and university may easily give students the benefit of visual presentation of alternating current phenomena through the use of an oscillograph. Studies of alternating current wave shapes and demonstrations of the effects of changing constants in circuits may be quickly and easily made.

● For Radio Dealers

The RCA Cathode Ray Oscillograph gives the Radio Dealer an instrument for comparison of receiver characteristics and for making extremely effective window displays. Selling-up from a low-priced instrument to a higher-priced one is much easier when the eye as well as the ear can note the difference in performance.

● For Manufacturers

The RCA Cathode Ray Oscillograph is a valuable instrument either for receiver development or production testing. Better engineering and quicker and better tests are a direct result of its use in the manufacturing field.

A Quality Product from the RCA Parts Division

How the Cathode Ray Oscillograph Works

The Cathode Ray Oscillograph is a new device in the field of service equipment and its functioning may not be fully understood by all service engineers. Actually, its operation is extremely simple, it being merely a voltmeter that also records time. The following explanation covers the essential fundamental functions of the device. A thorough explanation is included in the instruction book which accompanies all instruments and which may be obtained from your nearest RCA Parts Distributor for a nominal charge.

THE RCA CATHODE RAY TUBE

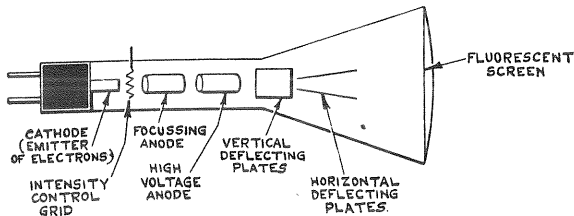

The heart of the Cathode Ray Oscillograph is the Cathode Ray Tube, a development of RCA Engineers to its present practical form. The Cathode Ray tube has often been called the "Electron Gun," as this describes its functions. The illustration shows an elementary diagram of the tube.

For the purpose of understanding the action of the "electron gun," one may consider the cathode as emitting electrons which are accelerated by the high voltage anodes and which strike the fluorescent screen at the end of the tube, thereby creating light. The course of the electrons is controlled by the two sets of deflecting plates, one for horizontal deflection and one for vertical deflection. The amount of deflection, which controls the location of the light-spot on the screen, is a direct function of the voltage at any particular instant on the deflecting plates.

From the foregoing it is seen that a pattern of light may be traced on the screen by the simultaneous application of voltages to the horizontal and vertical deflecting plates. If this action is repeated twenty or more times per second, the retentive power of the eye is such that the tracing will not be discernible and the entire pattern will be seen.

Focusing of the light beam on the fluorescent screen is accomplished by adjusting the voltage on the anode nearest the cathode. The intensity of light is controlled by the negative voltage applied to the grid.

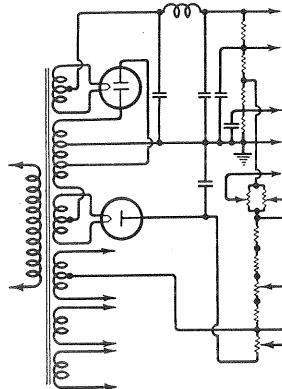

POWER SUPPLY

The high voltage anode of the Cathode Ray Tube requires 1000 volts DC for proper operation. Also DC voltages are required for the amplifier. The RCA-879 rectifier is used in a half-wave rectifying circuit for providing the necessary anode voltage for the RCA-906. The RCA-80, connected in a full-wave rectifying circuit, provides plate and grid voltages for the two RCA-57 amplifiers. While a single transformer is used for both rectifiers, individual filter circuits are provided. The transformer is over-size to prevent stray magnetic leakage that would otherwise affect the operation of the Cathode Ray Tube.

THE SAW-TOOTH OSCILLATOR

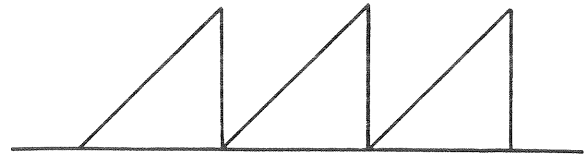

The external voltage under test is always connected to the vertical deflecting plates. However, unless some means is provided for moving the beam simultaneously in a horizontal direction, a beam rising and falling vertically will be obtained. As this would merely give an indication of the maximum voltage available, a means must be provided for simultaneously deflecting the beam horizontally. For this, the so-called variable frequency "saw-tooth" oscillator is necessary. The "saw-tooth" refers to the wave shape of the oscillator and is required because of the necessity for having the horizontal deflection increase in a linear manner and then abruptly return to zero and again shift across the screen. The frequency of the oscillator must have a definite relationship to the frequency of the voltage under test. For example, to examine one cycle, the saw-tooth oscillator must be the exact frequency of the voltage under test. If the saw-tooth oscillator is one-half of the frequency of the voltage under test, then two cycles will be shown on the screen at one time.

With the saw-tooth oscillator provided in the TMV-122-B the minimum number of cycles for the highest frequency is six, being obtained when a 90,000-cycle voltage is observed with the saw-tooth oscillator at 15,000 cycles. Higher frequencies may be examined by connecting directly to the vertical plates and using an external timing oscillator.

AMPLIFIERS

The sensitivity of the Cathode Ray Tube is such that a voltage of 75 is required for either a vertical or horizontal deflection of one inch. Because many voltages used in radio circuits are very small, an amplifier has been provided for each set of deflecting plates. Both amplifiers use an RCA-57 tube and have a high gain and wide frequency range. The gain is approximately 40 and the frequency range is 20 to 90,000 cycles $\pm 10\%$.

Designing an amplifier circuit of such wide frequency range is a difficult engineering problem. Its solution greatly increases the flexibility of the equipment.

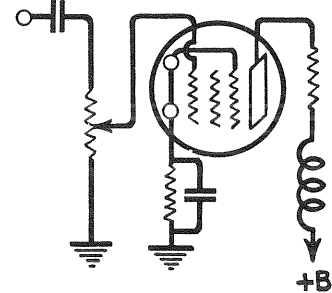

Specifications

Focusing

A special circuit with adjustable control on the front panel provides a means of accurately focusing the light beam on the screen.

Illumination

The light intensity is such that photographs may be easily made with ordinary commercial equipment. No hood is required.

Sensitivity

The sensitivity is guaranteed at two volts per inch. This feature gives large images for small input voltages.

Sweep Circuit

A linear saw-tooth oscillator, adjustable from 20 to 15,000 cycles, is provided. A special circuit provides a positive means for synchronizing this oscillator with the voltage under test. Binding posts are provided so that an external synchronizing voltage source also may be used.

Amplifiers

Two wide frequency range amplifiers are provided, one for horizontal and one for vertical deflection. The amplifiers are linear from 20 cycles to 90 kilocycles $\pm 10\%$. The gain is approximately 40.

Centering Adjustments

Two screwdriver adjustments are provided at the rear of the case for both vertical and horizontal beam centering adjustment.

Radiotrons Used

1 RCA-906, 1 RCA-879, 1 RCA-885, 1 RCA-80, 2 RCA-57; total 6.

Power Supply

Complete AC operation from 110-120-volt lines. Power consumption 50 watts.

Size

Height 12 $\frac{1}{4}$ inches (less handle), width 7 $\frac{3}{8}$ inches, length 17 $\frac{3}{4}$ inches.

Weight

39 pounds.

STOCK No. 9545

NET PRICE \$84.50



UNIVERSAL OUTPUT TRANSFORMER

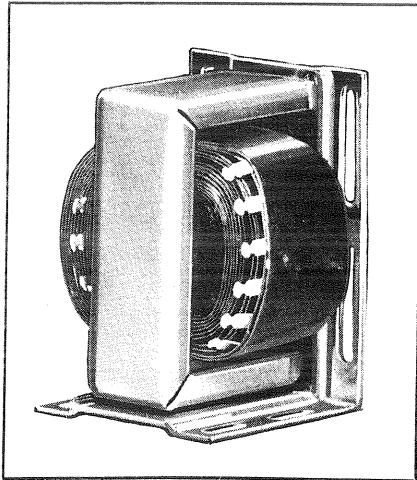

FOR OUTPUT TRANSFORMER
REPLACEMENT IN ALL SETS

Stock No.
7852

\$1.95

List
Price

(Subject to the Usual Trade Discounts)

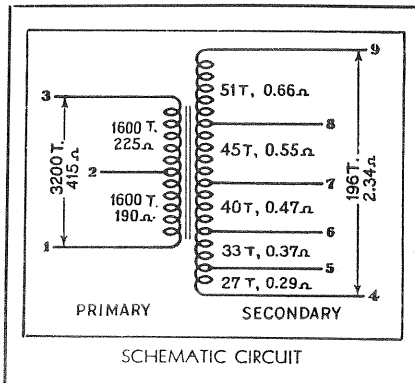

• One transformer for exact matching of all output tubes (either single or push-pull) to all dynamic loudspeakers. (Covers voice-coil impedances from 1 ohm to 15 ohms.)

• Universal mechanically as well as electrically. Angle bracket with slots for easy mounting on either chassis or loudspeaker frame.

• Wide frequency range—30 to 10,000 cycles. No distortion caused by mis-match of tubes or speaker.

• Silicon steel core eliminates possibility of damage from mechanical shock or from temporary electrical overload.

• Tinned soldering terminals for quickly attaching tube and speaker leads.

• Baked varnish impregnation gives protection against normal climatic conditions.

• Low net price insures adequate profit with minimum investment.

SPECIFICATIONS

Size—Standard Model— $2\frac{3}{4}'' \times 2\frac{1}{4}'' \times 2''$.

Cased Model— $2\frac{3}{4}'' \times 2\frac{3}{8}'' \times 3''$.

Voice Coil Impedances—1 to 15 Ohms.

Primary Load Impedances—1,000 to 20,000 Ohms.

Maximum Working Potential—500 Volts.

Maximum Plate Current (each tube)—55 Milliamperes.

Frequency Range—30 to 10,000 Cycles.

SPECIAL IMPREGNATED MODEL

For those extreme tropical conditions of high temperature and humidity, RCA has provided a special cased model of the Universal Output Transformer, having vacuum wax impregnated windings and complete potting in an asphalt compound for protection. The case is cadmium plated and fitted with a bakelite terminal board. Stock No. 7853—List Price, \$2.42.

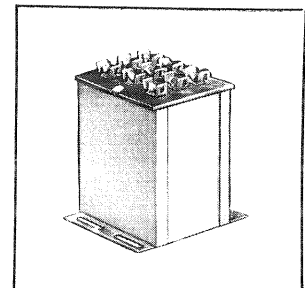

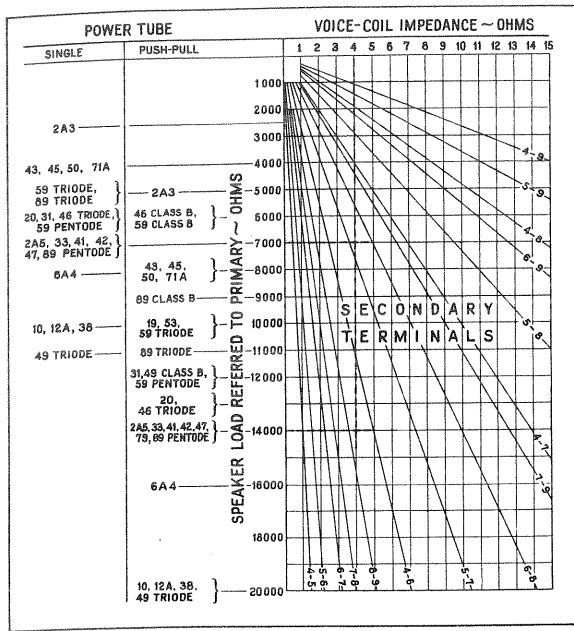

CONNECTING THE RCA UNIVERSAL OUTPUT TRANSFORMER

Terminal Numbers 1, 2 and 3 designate the primary start, mid-tap and finish, respectively, while terminals 4 to 9 indicate the various secondary taps in sequence. Always use the full primary winding either for a single-ended or push-pull power stage. In the former case, connect the plate to terminal 1 and the plate supply to terminal 3. For push-pull circuits, connect the plates to terminal Numbers 1 and 3 and the plate supply to terminal 2. A reference to the chart quickly shows the proper secondary terminal for the various combinations of speaker impedances and output tubes.

FREQUENCY RANGE OF RCA UNIVERSAL OUTPUT TRANSFORMER

The accompanying chart shows the transformer frequency range with various types of tubes and a 4-ohm speaker load. Obviously maximum undistorted output will be obtained at frequencies where the voice-coil impedance is at optimum value for the transformer ratio employed. When matching to mid-range is correct, best results will be ensured in that range. However, if matched to a higher than rated impedance, a decreased mid-range will result, but an improvement at the higher frequencies will be obtained. Often this is desirable to compensate for amplifier deficiencies, etc.

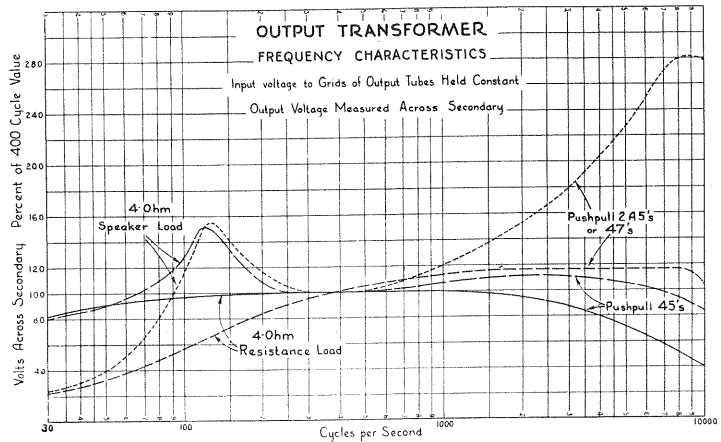

ORDER FROM YOUR RCA PARTS DISTRIBUTOR

RCA PARTS

RCA MANUFACTURING CO., INC.



DIVISION

CAMDEN, NEW JERSEY, U. S. A.

Check your frequency

...**ACCURATELY!** WITH THE

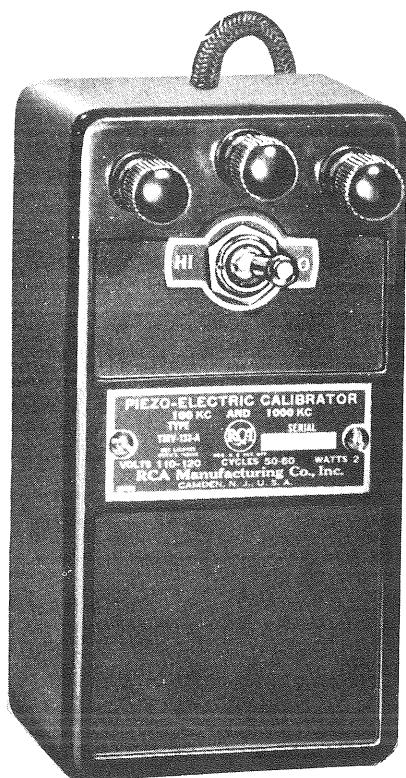

PIEZO-ELECTRIC CALIBRATOR

STOCK No. 9572

Give precision to your work by calibrating receivers, test oscillators and laboratory apparatus with the RCA Crystal Calibrator. It enables you to do a better job, guarantee the accuracy of your calibration and command a higher price for your work. . . A crystal oscillator, properly ground and accurately calibrated, maintains a more constant frequency than any other device known. The RCA Piezo-Electric Crystal Calibrator, which is a special crystal oscillator with two frequency modes, each having prolific harmonics, is an ideal standard for all accurate calibration work. Use it for better work.

NET PRICE **\$29⁹⁵** COMPLETE WITH CRYSTAL TUBE and POWER SUPPLY

CHECKS FREQUENCIES FROM:—

100 KC TO 20,000 KC IN 100 KC STEPS
1000 KC TO 50,000 KC IN 1000 KC STEPS
GUARANTEED ACCURACY 0.05 PERCENT OF 100 KC AND 1000 KC

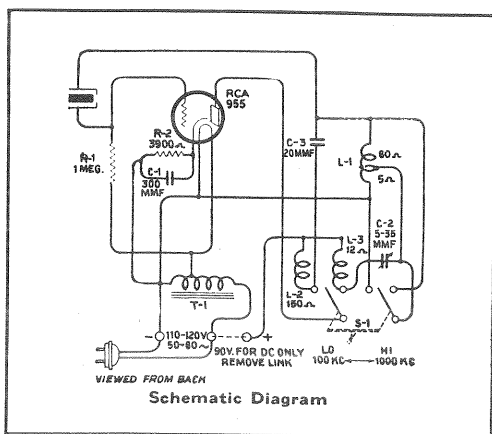

INDIVIDUAL CRYSTAL CALIBRATION AND TEMPERATURE AT WHICH MADE, FURNISHED WITH EACH INSTRUMENT. ACCURACY—2 PARTS IN 1 MILLION.

Schematic diagram of RCA Piezo-Electric Calibrator showing values of parts and internal connections.

OPERATION

The RCA Piezo-Electric Crystal Calibrator is placed in operation by inserting the power plug into a 110-120 volt, 50-60 cycle A-C line. The Frequency Selector Switch is then set either at "Hi" or "Lo", depending on whether the fundamental frequency of 1000 Kc or 100 Kc is desired. The Calibrator should then be placed adjacent to the receiver which may be tuned for the desired harmonic.

On the higher harmonics of 100 Kc, the 1000 Kc steps should be used as reference points. For example,

This same procedure will apply to other devices for which an accurate calibration is desired

a calibration point such as 15.5 megacycles is determined by first locating the 15 or 16 megacycle point and then counting forward or backward by 100 Kc steps.

When calibrating test oscillators, harmonics of the lower oscillator frequencies should be used to beat against harmonics of the Calibrator. For example, the 10th harmonic of 360 Kc on the oscillator to be calibrated will give a beat with the 3600 Kc signal from the Calibrator; likewise, the 10th harmonic of 370 Kc will give a beat with the 3700 Kc Crystal Calibrator signal. Interpolation between the 360 and 370 Kc points will give a 365 Kc point on the oscillator to be calibrated if it is desired to calibrate closer than 10 Kc.

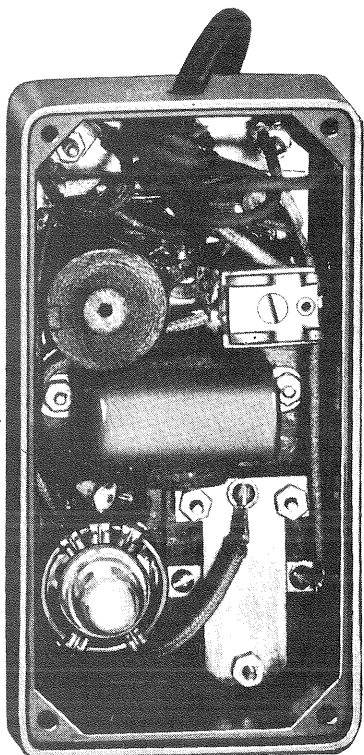

SPECIFICATIONS

Fundamental Frequencies . . .	100 Kc and 1000 Kc
Accuracy of Calibration . . .	$\pm 0.05\%$
Temperature Coefficient . . .	20 Cycles per 1000 Kc per $^{\circ}\text{C}$
Radiotron Used . . .	One RCA-955 (Acorn Type)
Power Required . . .	110-120-Volt, 50-60 Cycle A-C (90-135-Volt D-C plate supply may be connected externally for unmodulated operation if desired)
Power Consumption . . .	2 Watts
Controls	Hi-Lo Toggle Switch
Size	5 $\frac{1}{2}$ " x 3 $\frac{7}{8}$ " x 2 $\frac{5}{8}$ "
Weight	1 lb. 3 oz.

ORDER FROM YOUR RCA PARTS DISTRIBUTOR



RCA PARTS DIVISION

Form 299

RCA MANUFACTURING CO., Inc., CAMDEN, NEW JERSEY, U. S. A.

A Radio Corporation of America Subsidiary



Frequency Modulator

— FOR ALIGNING RECEIVERS WITH YOUR
RCA OSCILLOGRAPH

\$ **27.50**

NET PRICE

STOCK No. 9558



- ◆ **LOW PRICE**
- ◆ **SMALL SIZE**
- ◆ **LIGHT WEIGHT**

THE RCA FREQUENCY MODULATOR is a combined motor-driven capacitor and a-c generator designed primarily for aligning circuits with the RCA Oscillograph and the RCA Test Oscillator.

For visual alignment of r-f and i-f circuits in superheterodyne radio receivers with an oscillograph, it is necessary to have an r-f signal of varying frequency connected to the circuit under test and to generate an a-c synchronizing voltage simultaneously with such frequency variation.

The three conditions necessary for visual alignment are:

★ The unmodulated r-f signal frequency variation must slightly exceed the resonant fre-

quency of the circuit under test.

★ The variation of this unmodulated r-f signal must be at a greater rate than that discernible to the eye so that a flicker will not result.

★ The r-f oscillator sweeping frequency must be synchronized with the horizontal "saw-tooth" sweeping frequency of the oscillograph.

The RCA Frequency Modulator and a test oscillator, such as RCA Test Oscillator Stock No. 9595, satisfy these three conditions.

A QUALITY PRODUCT FROM THE RCA PARTS DIVISION

FEATURES

TWO PURPOSES—The RCA Frequency Modulator functions both as a sweep capacitor and as an A.C. impulse synchronizing generator.

TWO RANGES—The RCA Frequency Modulator has two sweep capacity ranges, one of 25 to 70 mmfd. and one of 15 to 37 mmfd. A two-position toggle switch on the front panel permits choice of either range during operation.

BALANCED CAPACITOR—The sweep capacitor rotor is divided into two equal sections, which are mounted 180° apart on the shaft, thereby giving a perfect balance at all angles of rotation.

25 SWEEPS PER SECOND—25 sweeps per second in each direction eliminate all possibility of screen flicker of the projected curve.

IMPULSE GENERATOR—To properly synchronize the curve on the cathode ray tube screen, a synchronizing voltage is necessary. Such a voltage is provided in the RCA Frequency Modulator by having a small A.C. generator driven from the sweep capacitor shaft.

PEAKED WAVE-FORM—The output of the impulse generator has a very peaked wave-form instead of the usual sine wave of A.C. generators. Such a wave-form gives a very positive means of synchronizing the horizontal "saw-tooth" oscillator of the cathode ray oscillograph with the output of the receiver under test.

OUTPUT BINDING POSTS—Two binding posts are provided for connecting the synchronizing voltage to the Cathode Ray Oscillograph.

SPECIFICATIONS

SWEEP CONDENSER—Two sections — High range, 25 to 70 mmfd. Low range, 15 to 37 mmfd. Panel switch for paralleling these sections when the high range is desired.

CONNECTING CABLE—14-in. low-capacity connecting cable with plugs at each end.

GENERATOR FREQUENCY—Two cycles per revolution permit positive synchronizing for double-sweep alignment.

GENERATOR VOLTAGE—1.5 volts minimum.

MOTOR—Repulsion induction type—1550 R.P.M.

PANEL CONTROLS—"Hi-Lo" capacity switch, "On-Off" switch, output binding posts and single-circuit jack.

SIZE—Height 8½ inches (including raised handle), case alone 6½ inches, width 9¾ inches, depth 4½ inches.

WEIGHT—5¼ pounds.

CURRENT CONSUMPTION—25 watts.

ORDER FROM YOUR RCA PARTS DISTRIBUTOR

RCA PARTS

RCA MANUFACTURING CO., INC.



DIVISION

CAMDEN, NEW JERSEY, U. S. A.

New

RCA RK-40 ANTENNA

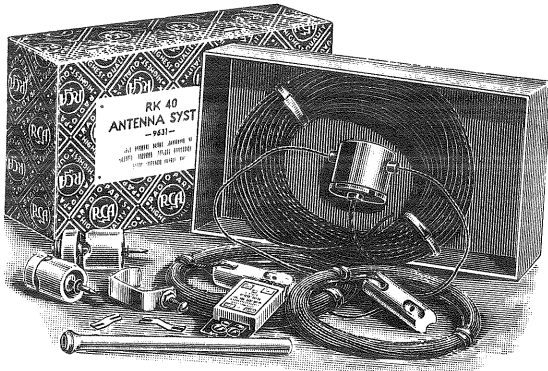

List Price \$5⁵⁰

STOCK NO. 9631

A scientific all-wave antenna system for receivers of all types and manufacture. Complete, ready to install. No assembling or parts required for installation.

FACTORY ASSEMBLED • EASILY INSTALLED

The new RCA RK-40 Antenna is a simplified antenna system designed to reduce the time and labor required for antenna installation in the most difficult of locations. It is merely necessary to attach each end to supports and make connections to the receiver. The time and money saved by installing this easily erected antenna means more business and more profits for you. The low price enables you to sell it to customers of more modest incomes. RCA design means more signals for your customers and better acceptance everywhere. Cash in on this improved, easily erected RCA Antenna by recommending it to your customers.

HOW IT WORKS

The RCA RK-40 Antenna consists of a special doublet, a transposed transmission line, an antenna junction box and a

receiver coupling unit. The antenna acts as an efficient pick-up medium, giving high signal strength over an extremely wide frequency range. The transmission line efficiently conveys this energy from the antenna to the receiver, while the receiver coupling unit matches the transmission line to the input receiver circuits. Such a system gives adequate coverage of all short- and long-wave broadcast bands and presents a minimum in installation work in conjunction with its erection.

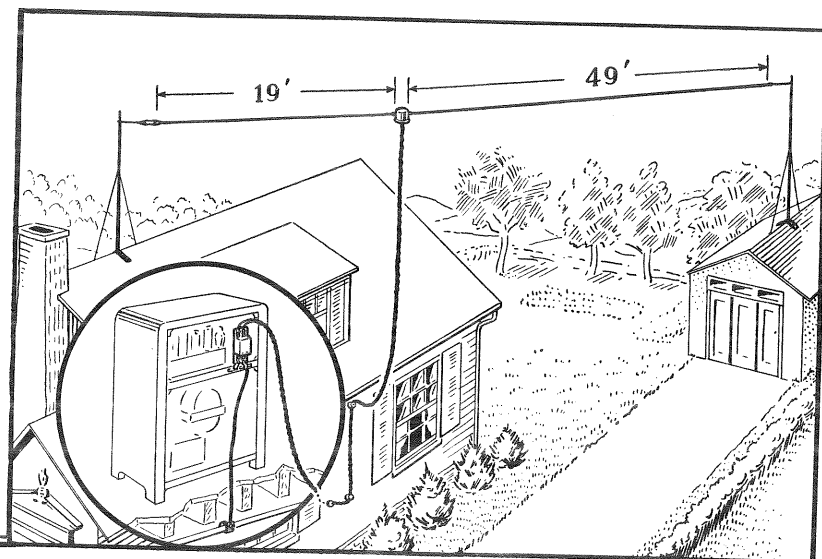

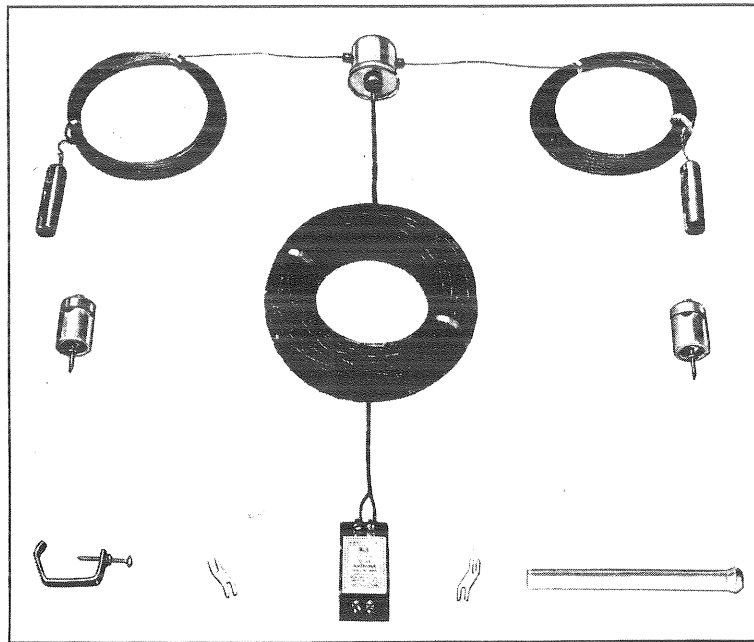

HERE'S WHAT YOU GET

- 1 Antenna Assembly comprising:
 - (a) Antenna Wire Coil 19 feet long with Strain Insulator attached.
 - (b) Antenna Wire Coil 49 feet long with Strain Insulator Attached.
 - (c) Transmission Line Coil of special two conductor insulated cable 75 feet long.
 - (d) Hermetically Sealed Junction Box to which the two antenna wires and the transmission line are connected.
- 2 Receiver Coupling Unit with two links for attachment to "Ant." and "Gnd." terminals or clips on radio receiver.
- 3 Two Nail-on Porcelain Knob Insulators for carrying transmission line on side of building or other supporting surface.
- 4 Porcelain-tube Lead-in Insulator for entrance of transmission line into building.
- 5 Ground Clamp for attachment of ground wire to water pipe or to stake driven 5 to 8 feet into the soil.

ORDER FROM YOUR RCA PARTS DISTRIBUTOR



PARTS DIVISION

RCA MANUFACTURING CO., Inc., CAMDEN, NEW JERSEY, U. S. A.

A Radio Corporation of America Subsidiary

PARTS AND ACCESSORIES

Use RCA Parts with All Receivers

RCA POWER TRANSFORMERS 10-12 TUBE SETS

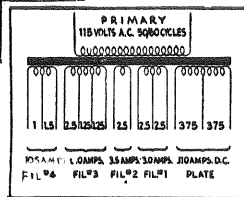
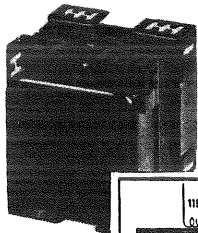

A heavy-duty transformer capable of handling the largest of standard receivers. Heavy core, high voltage plate winding, removable end-bells and rugged construction make this a transformer capable of meeting the most severe requirements. Stock No. 9551 . List Price \$6.00

CLASS B SETS

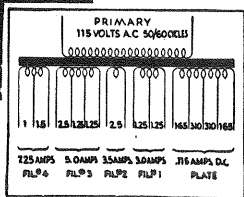
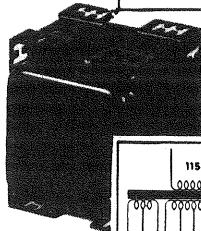

Exceptionally high (475/475) voltage plate winding and high current carrying capacity make this a transformer suitable for Class "B" output amplifiers. Good regulation and the usual RCA features make this an exceptional value. Stock No. 9552 . List Price \$6.50

5-9 TUBE SETS

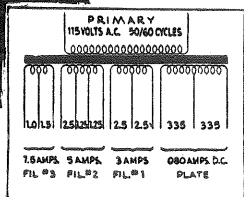
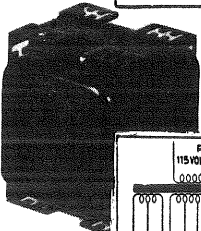

The most popular of the RCA Universal Transformers because it fits the greatest number of receivers. A quality transformer you can use on receivers of many types and manufacture. Stock No. 9553. List Price \$4.75

4-TUBE SETS

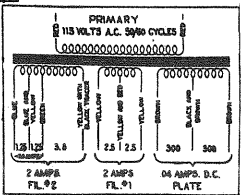

A high quality small transformer for midget four-tube receivers. Incorporates the high quality features needed for a transformer of this type. Stock No. 9556. List Price \$2.06

RCA UNIVERSAL OUTPUT TRANSFORMER

The RCA Universal Output Transformer is designed for exact matching of all output tubes (either single or push-pull) to all dynamic loudspeakers having voice coil impedances from 1 to 15 ohms. Stock No. 7852 has a baked varnish impregnation which gives protection against normal climatic conditions. Stock No. 7853 is a special impregnated model for extreme tropical conditions. Stock No. 7852. List Price \$1.95
Stock No. 7853. List Price \$2.42

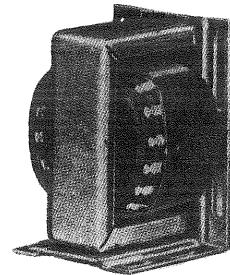

THE RCA BEAT OSCILLATOR

The RCA Beat Oscillator is designed to be used for the best reception of continuous wave signals on either short wave or broadcast type receivers. Covers all i-f frequencies from 415 kc. to 700 kc. Includes easily installed connectors. Requires 1 RCA-58 or 1 RCA-6D6 (not included). Stock No. 9606. Net Price \$7.50

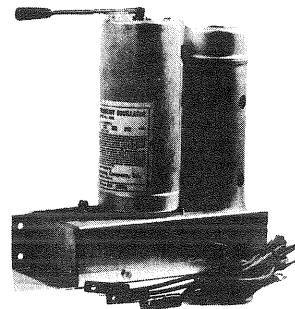

RCA PHONOGRAPH OSCILLATOR

The RCA Phonograph Oscillator may be used to connect any type of magnetic pickup to any type of receiver without making internal connections. Functions on the principle of a miniature broadcasting station and may be tuned in from 1400 kc. to 1700 kc. on the receiver. Uses 1 RCA-2A7 or RCA-6A7 (not included). Stock No. 9554. . List Price \$7.75

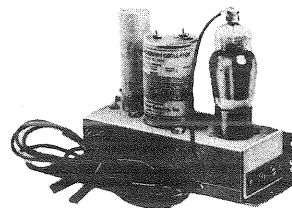

RCA SERVICE NOTES

The six bound volumes of RCA Victor Service Notes cover all RCA or Victor models produced from 1923 to 1936. Complete replacement parts list are provided for models issued since 1929. Net Price \$1.00 per volume
F. O. B. Camden, N. J.

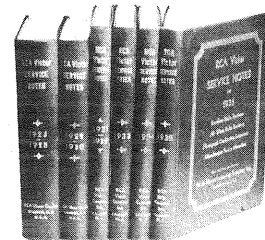

RCA MANUFACTURING CO., INC. PARTS DIVISION

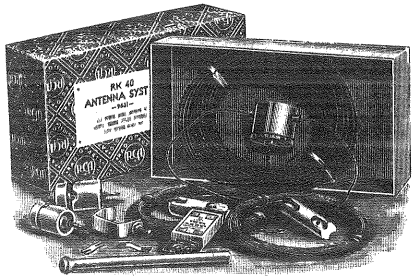

RCA RK-40 ANTENNA

The RCA RK-40 Antenna is a simplified antenna system designed to reduce the time and labor required for antenna installation in the most difficult of locations. It is merely necessary to attach each end to supports and make connections to the receiver. The time and money saved by installing this easily erected antenna means more business and more profits for you. The low price enables you to sell it to customers of more modest incomes. RCA design means more signals for your customers and better acceptance everywhere. Cash in on this improved, easily erected RCA Antenna by recommending it to your customers. Stock No. 9631. List Price \$5.50

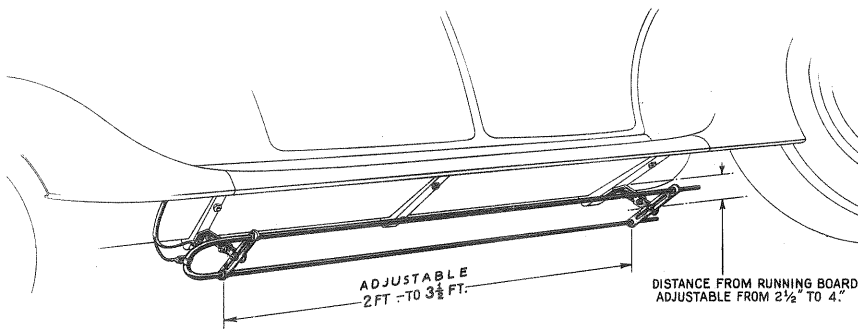

RCA DI-POLE AUTO ANTENNA

The RCA Noise-Reducer Di-Pole Auto Antenna is an entirely new development in automobile antenna design. It's easily and quickly installed on any car, gives efficient pickup from stations and eliminates all ignition noise pickup by the antenna. It is as sensational in the automotive field as the famous RCA World-Wide Antenna is in the home field. Its low price insures a ready sale to any automobile radio purchaser. Works with any set. Stock No. 9605. List Price \$2.60

RCA DELUXE STORE ANTENNA

The RCA DeLuxe Store Antenna reduces man-made static on both short-wave and standard programs, besides picking up weak foreign stations seldom heard on ordinary antennas. You can demonstrate all-wave sets in your store, when the prospect's interest is high.

By means of a unique switching arrangement, the antenna may be instantly connected to any one of four receivers merely by rotating a selector switch knob. Helps you to compare sets and "sell-up" from low-price models. Stock No. 9580. Net Price \$10.80

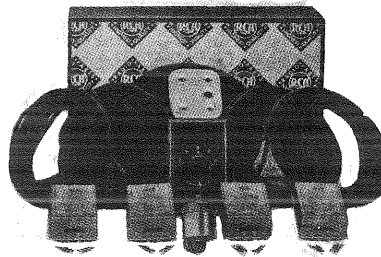

RCA WORLD-WIDE ANTENNA KIT OF ESSENTIAL PARTS

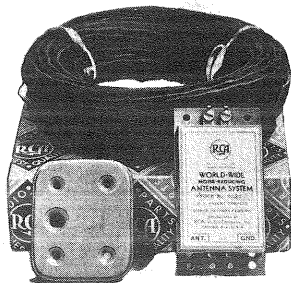

For dealers, service engineers, or experimenters, who may prefer to buy standard parts locally, the Kit of Essential Parts of the RCA World-Wide Antenna System is provided. All the advantages of the standard Kit may be obtained by the use of this Kit plus antenna wire, insulators, etc., purchased locally. A special instruction sheet discusses results obtained with different lengths of antenna wire and different types of installations.

Contents of Kit: 1 Roll Transmission Line (80 feet). 1 Receiver-Coupling Transformer. 1 Crossover Insulator. Stock No. 9550. List Price \$5.00



ANTENNA SYSTEMS

RCA PARTS DIVISION

RCA MANUFACTURING COMPANY, INC.
CAMDEN, NEW JERSEY, U.S.A.
Distributors in Principal Cities

Listen to C-W Code Signals

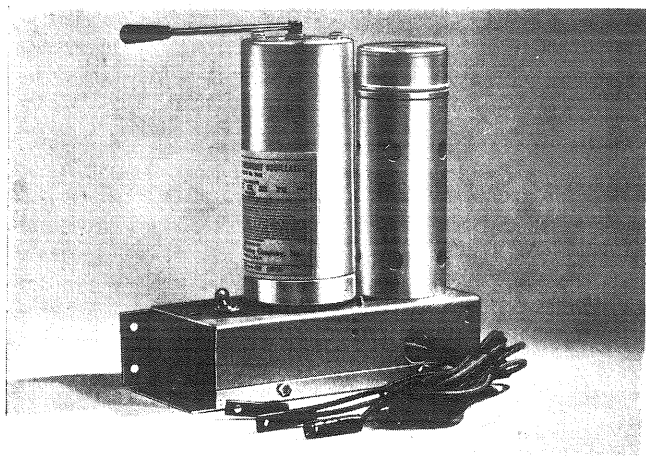

with this

RCA BEAT OSCILLATOR

AND YOUR PRESENT SHORT WAVE RECEIVER

With this instrument attached to a short wave super-heterodyne home receiver, anyone can listen to the many continuous wave code signals that would otherwise be inaudible. Also useful for tuning any weak signal by the sensitive "birdie" method.

NET PRICE

\$7.50

STOCK No. 9606

★ The RCA Beat Oscillator is a compact, un-modulated C-W oscillator having a frequency range from 415 kc. to 700 kc. It is designed to be used for the beat reception of continuous wave signals on either short wave or broadcast type receivers. Such reception is accomplished by the beat oscillator heterodyning the intermediate frequency signal, thereby creating an audio signal which is readily heard in the earphones or loudspeaker of any home receiver. A vernier adjustment, for controlling the frequency, or pitch, of the beat note, is fitted with a long handle, thus permitting fine adjustments. The oscillator may be operated with receivers using either 2.5-volt or 6.3-volt tubes, and is provided with easily attached terminals for obtaining plate and filament supply from the receiver.

Specifications

- ★ **CIRCUIT.** Electron-coupled, having excellent frequency stability.
- ★ **FREQUENCY RANGE.** 415 kc. to 700 kc.
- ★ **RADIOTRON REQUIRED.** 1 RCA-58 or 1 RCA-6D6 (not included).
- ★ **CONTROLS.** Fine frequency adjustment and "on-off" switch.
- ★ **SIZE.** Height, 7 inches; width, 2 $\frac{3}{4}$ inches; length, 7 inches. **WEIGHT:** 2 pounds.

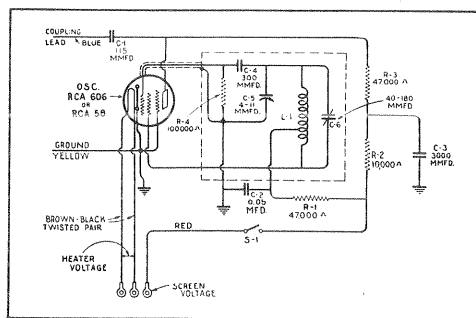

Schematic Circuit Diagram

RCA PARTS



DIVISION

RCA MANUFACTURING CO., INC.,

CAMDEN, NEW JERSEY, U. S. A.