

# RCA VICTOR MODELS 7T, 7K, 8T, and 8K

## Seven-Tube and Eight-Tube, Three-Band, A-C, Superheterodyne Receivers

### TECHNICAL INFORMATION

#### Electrical Specifications

<p><b>FREQUENCY RANGES</b></p> <p>"Standard Broadcast"..... 530- 1,800 kc</p> <p>"Medium Wave"..... 1,800- 6,300 kc</p> <p>"Short Wave"..... 6,300-22,000 kc</p> <p>Intermediate Frequency..... 460 kc</p> <p><b>RADIOTRON COMPLEMENT</b></p> <p>(1) RCA-6L7.....First Detector</p> <p>(2) RCA-6J7.....Oscillator</p> <p>(3) RCA-6K7.....Intermediate Amplifier</p> <p>(4) RCA-6H6.....Second Detector and A.V.C.</p> <p>Pilot Lamps (3).....Mazda No. 46, 6.3 volts, 0.25 amperes</p> <p><b>POWER-SUPPLY RATINGS</b></p> <p>Rating A..... 105-125 volts, 50-60 cycles, 80 watts</p> <p>Rating B..... 105-125 volts, 25-60 cycles, 80 watts</p> <p>Rating C..... 100-130/140-160/195-250 volts, 40-60 cycles, 80 watts</p> <p><b>POWER OUTPUT</b></p> <p>Undistorted..... 2 watts</p> <p>Maximum..... 4.5 watts</p>	<p><b>ALIGNMENT FREQUENCIES</b></p> <p>"Standard Broadcast"..... 600 kc (osc.), 1,500 kc (osc., ant.)</p> <p>"Medium Wave"..... 6,000 kc (osc., ant.)</p> <p>"Short Wave"..... 20,000 kc (osc., ant.)</p> <p>460 kc</p> <p>(5) RCA-6F5.....Audio Voltage Amplifier</p> <p>(6) RCA-6F6.....Power Output</p> <p>(7) RCA-5Z4.....Full-Wave Rectifier</p> <p>(8) RCA-6E5 (Models 8T and 8K only).Tuning Tube</p> <p><b>LOUDSPEAKER</b></p> <p>Type..... Electrodynamic</p> <p>Impedance (V.C.)..... 2.2 ohms at 400 cycles</p>
---	--

#### Mechanical Specifications

CABINET DIMENSIONS	7T	7K	8T	8K
Height .....	20 $\frac{1}{4}$ inches.....	39 inches.....	21 $\frac{7}{8}$ inches.....	40 inches
Width .....	14 $\frac{7}{8}$ inches.....	24 $\frac{3}{8}$ inches.....	15 $\frac{5}{16}$ inches.....	25 $\frac{1}{2}$ inches
Depth .....	8 $\frac{3}{8}$ inches.....	12 inches.....	8 $\frac{3}{4}$ inches.....	12 $\frac{1}{16}$ inches
<b>WEIGHTS</b>				
Net .....	24 pounds.....	50 pounds.....	26 pounds.....	51 pounds
Shipping .....	29 pounds.....	65 pounds.....	33 pounds.....	67 pounds
Chassis Base Dimensions.....				12 inches x 7 inches x 2 $\frac{1}{2}$ inches
Over-all Height of Chassis.....				8 $\frac{3}{8}$ inches
Operating Controls.....	(1) Volume, (2) Tuning, (3) Range Selector, (4) Power Switch-Tone			
Tuning Drive Ratios.....	10 to 1 and 50 to 1			

#### General Description

These receivers represent the result of thorough development, design, and substantial manufacture. Noteworthy technical improvements have been applied in achieving marked advantages of operation and efficiency of performance.

Model 7T is a seven-tube, table-type, superheterodyne receiver with an eight-inch electrodynamic loudspeaker. Model 7K differs from the Model 7T in that it is of the console type and has a twelve-inch electrodynamic loudspeaker.

Models 8T and 8K are similar to Models 7T and 7K respectively, except for the addition of a tuning tube "Magic Eye" and different cabinet designs.

Design features incorporated in these receivers include: built-in doublet antenna coupler; improved

plunger-type air-dielectric adjustable trimming capacitors in the antenna and oscillator coil circuits; high-efficiency first detector (converter) with separate oscillator; magnetite core adjusted i-f transformers, low-frequency oscillator tracking, and wave-trap; aural compensated volume control; continuously variable tone control with music-voice switch; automatic volume control; phonograph terminal board; band selective indication of dial scales; and a dust-proof electrodynamic loudspeaker.

The tuning range is continuous through the "Standard broadcast," "Medium wave," and "Short wave" bands. This extensive range includes the important short-wave broadcast bands at 49, 31, 19, 16, and 13 meters in addition to channels assigned for

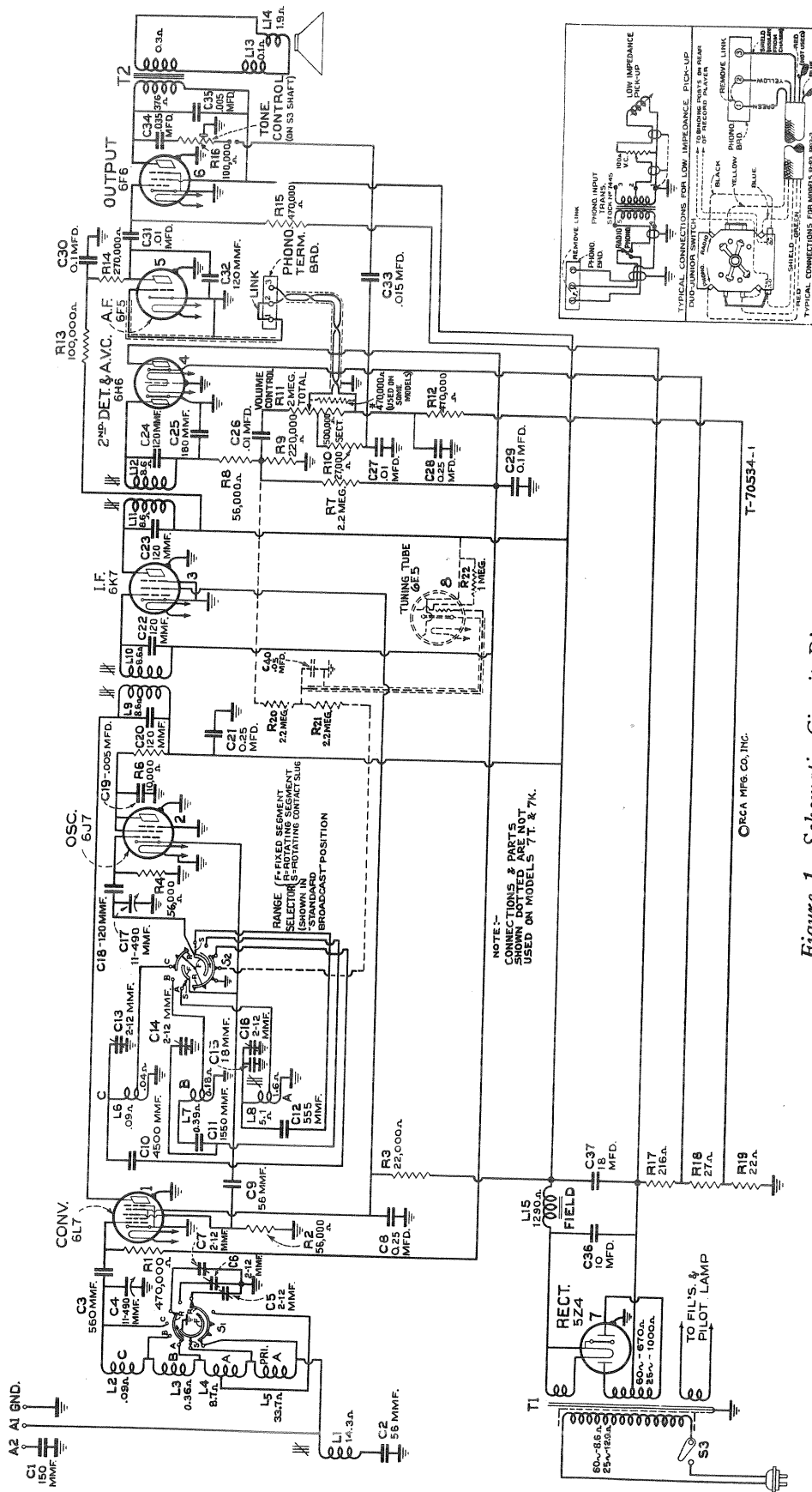

Figure 1—Schematic Circuit Diagram  
(\* 470,000-ohm resistor not required when replacing volume control with Stk. No. 13144)

SERVICE HINT.

Excessive heating of the 6E5 tube may be due to high cathode current—in excess of 7 ma. The tube should be replaced and the condition of the 5Z4 rectifier checked.

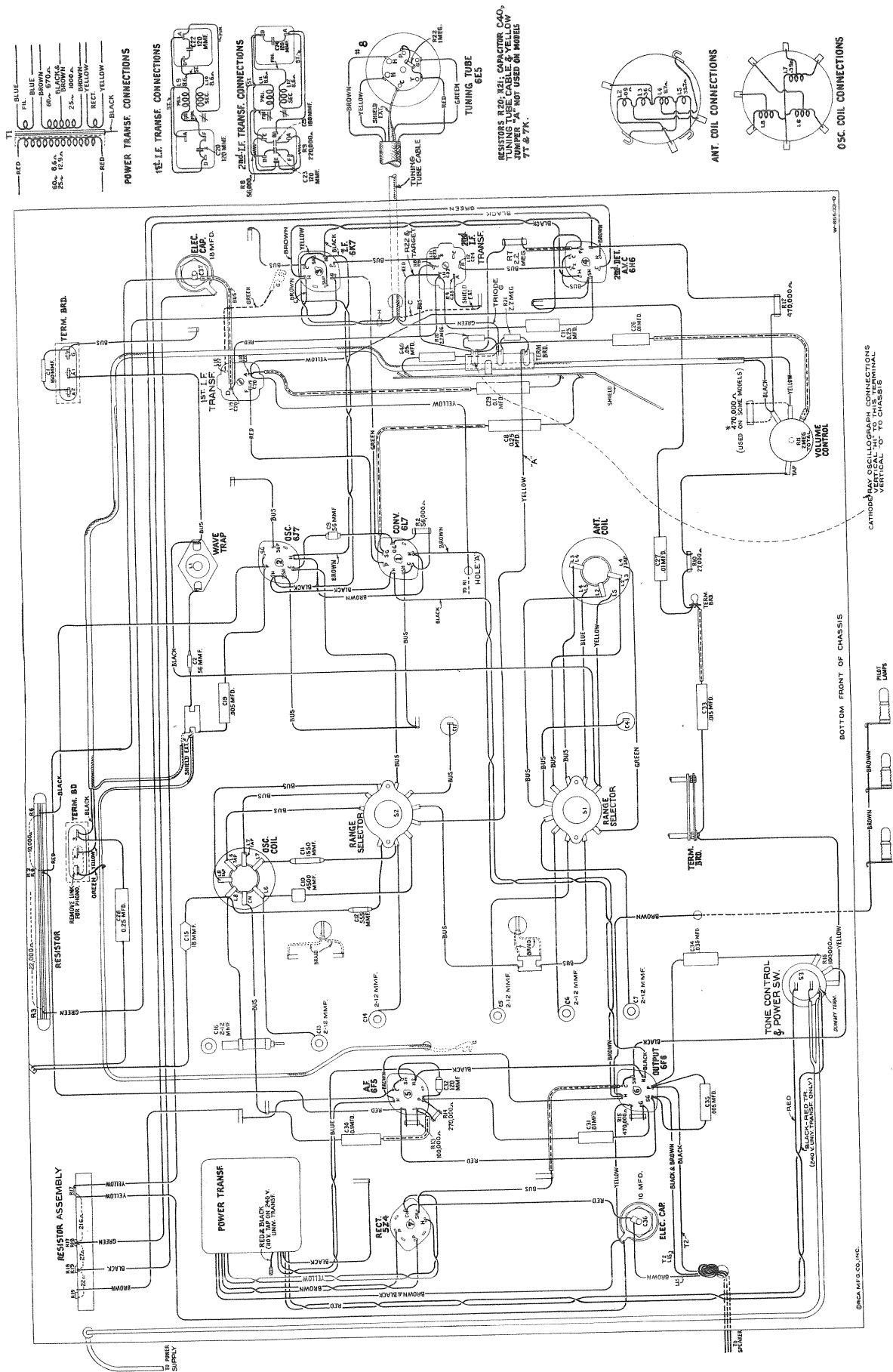

Figure 2—Chassis Wiring Diagram

police, amateur, and aviation communication. Trimming adjustments are located at accessible points. Their number is reduced to the least that is consistent with efficient operation. A double tuning knob

arrangement permits the choice of either a ten-to-one or a fifty-to-one dial ratio, the latter permits ease of tuning, especially in the "Medium wave" and "Short wave" bands.

## Circuit Arrangement

The conventional type of superheterodyne circuit is used. It consists of a first-detector (converter) stage, separate oscillator stage, a single i-f stage, a diode-detector — automatic-volume-control stage, an audio voltage-amplifier stage, a pentode power-output stage, and a full-wave rectifier stage. Models 8T and 8K also have a tuning indicator "Magic Eye."

A single-wire antenna, or a doublet antenna, when connected to the proper input terminals of the receiver, is coupled to control grid No. 1 of the RCA-6L7 through a tuned r-f transformer. This transformer is tapped so that the range selector increases the range of tuning by decreasing the amount of inductance. A unique method of switching causes L5 to become the primary with L4, L3, and L2 as secondary, L4 to become the primary with L3 and L2 as secondary, and L3 to become the primary with L2 as secondary, for range selector positions "Standard broadcast," "Medium wave," and "Short wave" respectively. Separate windings are employed

### Detector and A.V.C.

The modulated signal as obtained from the output of the i-f stage is detected by an RCA-6H6 twin-diode tube. The audio frequency secured by this process is transferred to the a-f system for amplification and final reproduction. The d-c voltage which results from detection of the signal is used for automatic volume control. This voltage, which develops across resistor R9, is applied as automatic control-grid bias to the first-detector and i-f tubes. The second (auxiliary) diode of the RCA-6H6 is used to supply residual bias to the controlled tubes under conditions of little or no signal. This diode, under such conditions, draws current which flows through resistors R7 and R9, thereby maintaining the desired operating bias on such tubes. On application of signal energy above a certain level, however, the auxiliary bias-diode ceases to draw current and the a.v.c.-diode takes over the biasing function.

### Audio System

The manual volume control consists of an acoustically tapered potentiometer in the audio circuit between the output of the detector diode and the input grid of the audio voltage-amplifier tube. This control has a tone-compensating filter connected to it so that the correct aural balance will be obtained at different volume settings. Phonograph terminals are inserted at this point for feeding the output of an external phonograph pickup to the control grid of the audio amplifier. Resistance-capacity coupling is used between the first-audio stage and the power-output stage. The power-output stage is transformer-coupled to the electrodynamic loudspeaker. Continuously-variable tone control is effected by means of capacitor C34 and variable resistor R16 shunting the plate circuit of the output tube. Extreme clockwise rotation of this tone control disconnects the resistor R16 from the circuit and places an additional capacitor C33 in shunt with capacitor C27, thereby reducing the low-frequency response of the amplifier. This point is known as the "Speech" position and provides optimum intelligibility of speech.

### Tuning Indicator (Models 8T and 8K only)

An RCA-6E5 cathode-ray tuning tube is used as a means of visually indicating when the receiver is accurately tuned to the incoming signal. This tube consists of an amplifier section and a cathode-ray section built in the same glass envelope. Maximum sensitivity of the tuning indicator is acquired in the "Short wave" position of the range selector S2 by removing the ground connection from resistor R21. In this position, resistors R20 and R21 no longer act as a voltage divider and maximum voltage is applied to the grid of the tuning tube.

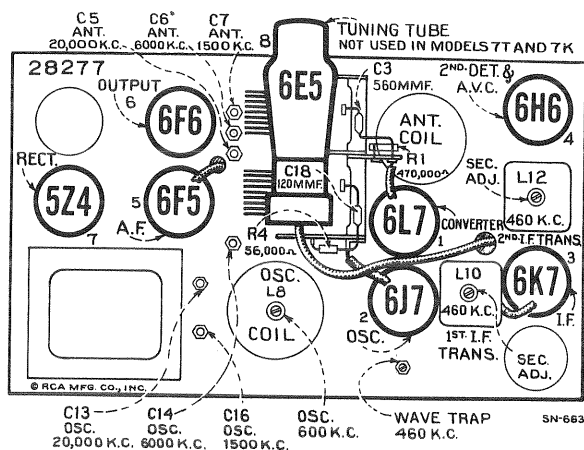

Figure 3—Radiotron, Coil, and Trimmer Locations

in the oscillator stage for each position of the range selector. All unused portions of the antenna and oscillator coils are shorted out to prevent undesirable interaction. Air-dielectric trimming capacitors are used for obtaining exact alignment. Proper low-frequency tracking of the oscillator for "Standard broadcast" is accomplished by adjusting the inductance of the respective coil with a molded magnetite core.

The intermediate-frequency amplifier consists of an RCA-6K7 in a transformer-coupled circuit. The windings of these transformers are resonated with fixed capacitors, and are adjusted by molded magnetite cores (both primary and secondary) to tune to 460 kc.

## SERVICE DATA

### Alignment Procedure

There are eight adjustments required for the alignment of the antenna, oscillator, and wave-trap tuned circuits. Six of these adjustments are made with plunger-type air trimming capacitors, and require the use of an RCA Stock No. 12636 adjusting tool. The other two adjustments are screws attached to molded magnetite cores and are used to adjust the wave-trap and to align the oscillator at 600 kc. Before adjusting the plunger-type air trimmers, they must be unlocked by loosening their hexagon lock nuts. The lock nuts should be tightened upon completion of adjustments.

The i-f transformer adjustments are made by means of four screws attached to molded magnetite cores.

All of the adjustable circuits of this receiver have been properly aligned at the factory to give correct performance, and their settings should remain intact indefinitely when the receiver is used under ordinary

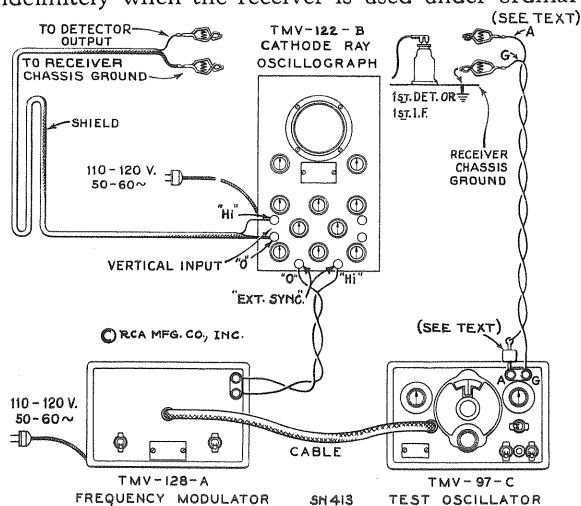

Figure 4—Alignment Apparatus Connections

conditions. However, necessity for re-adjustment may occasionally occur from continued extremes of temperature, climate, tampering, or purported alteration for services, or after repairs have been made to the r-f or i-f tuned circuits. Improper alignment usually causes the impairment of sensitivity, selectivity, and tone quality. Such conditions will generally exist simultaneously.

In re-adjusting the tuned circuits, it is important to apply a definite procedure and to use adequate and reliable test equipment. A standard test oscillator, such as an RCA Stock No. 9595, will be required as the source of signal at the specified alignment frequencies. Means for indication of the receiver output during alignment is also necessary to accurately show when the correct point of adjustment is reached. Two indication methods are applicable—one requires use of the cathode-ray oscillograph, and the other requires a voltmeter or glow-type indicator. The cathode-ray alignment method is advantageous in that the indication provided is in the form of a wave image which represents the resonance characteristics of the circuits being tuned. This type of alignment is

possible through use of apparatus such as the RCA Stock No. 9558 Frequency Modulator and the RCA Stock No. 9545 Cathode-Ray Oscillograph. The output indicator method should be performed with an instrument such as the RCA Stock No. 4317 Neon Glow Indicator. The two procedures are outlined as follows:

### Cathode-Ray Alignment

Make alignment apparatus connections shown on figure 4. Remove the plug of the frequency modulator cable from the test oscillator jack. Connect the receiver chassis to a good external ground. Connect oscillograph "Vertical" input terminals as indicated on figure 2. Set oscillograph power switch to "On" and adjust "Intensity" and "Focus" controls to give a clearly defined spot, or line, on the screen. Set oscillograph "Ampl. A" switch to "On," "Vertical gain" control full-clockwise, "Ampl. B" switch to "Timing," "Range" switch to No. 2 position, and "Timing" switch to "Int." Place the "Sync." control, "Freq." control, and "Horizontal gain" control to about their mid-positions. For each of the following adjustments, the test oscillator output must be regulated so that the image obtained on the oscillograph screen will be of the minimum size for accurate observation. The receiver volume control setting is optional.

### I-F Adjustments

- Connect the "Ant." output of the test oscillator to the grid cap of RCA-6K7 (with grid lead in place) through a .001-mfd. capacitor, with "Gnd." to receiver chassis. Tune the test oscillator to 460 kc, place its modulation switch to "On" and its output switch to "Hi."
- Turn on the receiver and test oscillator. Increase the output of the test oscillator until a deflection is noticeable on the oscillograph screen. The figures obtained represent several waves of the detected signal, the amplitude of which may be observed as an indication of output. Cause the wave image formed (400-cycle waves) to be spread completely across the screen by adjusting the "Horizontal gain" control. The image should be synchronized and made to remain motionless by adjusting the "Sync." and "Freq." controls.
- Adjust the two magnetite core screws (see figures 3 and 7) of the second i-f transformer (one on top and one on bottom) to produce maximum vertical deflection of the oscillographic image. This adjustment places the transformer in exact resonance with the 460-kc signal.
- The sweeping operation should follow using the frequency modulator. Shift the oscillograph "Timing" switch to "Ext." Insert plug of frequency modulator cable in test oscillator jack. Turn the test oscillator modulation switch to "Off." Turn on the frequency modulator and place its sweep-range switch to "Hi."
- Increase the frequency of the test oscillator by slowly turning its tuning control until two sep-

arate, distinct, and similar waves appear on the screen. If only one wave appears, increase the "Freq." control on the oscillograph to obtain two waves. These waves will be identical in shape, totally disconnected, and appear in reversed positions. They will have a common base line, which is discontinuous. Adjust the "Freq." and "Sync." controls of the oscillograph to make them remain motionless on the screen. Continue increasing the test oscillator frequency until these forward and reverse curves move together and overlap, with their highest points exactly coincident. This condition will be obtained at a test oscillator setting of **approximately 575 kc.**

- (f) With the images established as in (e), re-adjust the two magnetite core screws on the second i-f transformer so that they cause the curves on the oscillograph screen to become exactly coincident throughout their lengths and have maximum amplitude.
- (g) Without altering the adjustments of the apparatus, shift the "Ant." output of the test oscillator to the input of the i-f system, i.e., to the RCA-6L7 first-detector grid cap through a .001-mfd. capacitor (with grid lead in place). Regulate the test oscillator output so that the amplitude of the oscillographic image is approximately the same as used above for adjustment (f).
- (h) The two first i-f transformer magnetite core screws (one on top and one on bottom) should then be adjusted so that they cause the forward and reverse curves to become coincident throughout their lengths and have maximum amplitude. The composite wave obtained in this manner represents the resonance characteristic of the total i-f system. Lack of symmetry or irregularity of the resultant image will indicate the presence of a defect in the i-f system.

#### R-F Adjustments

Calibrate the pointer of the tuning dial by adjusting it to the extreme low-frequency end of dial scale (beyond 55 on dial) with the plates of the gang tuning condenser in full mesh. Alignment must be made in the sequence of "Short wave" band, "Medium wave" band, "Wave-trap," and "Standard broadcast" band.

#### "Short Wave" Band

- (i) Connect the "Ant." output of the test oscillator to the antenna terminal "A1" through a 300-ohm resistor. Remove the plug of the frequency modulator cable from the test oscillator. Turn test oscillator modulation switch to "On." Shift the oscillograph "Timing" switch to "Int."
- (j) Set receiver range selector to its "Short wave" position and dial pointer to 20,000 kc. Adjust the test oscillator to 20,000 kc. Set oscillator air trimmer C13 to minimum capacity (plunger full out), and antenna air trimmer C5 to maximum capacity (plunger full in). Slowly push in oscillator trimmer C13 until maximum (peak) amplitude of output is reached. Two peaks may be found. Adjust C13 to the peak with minimum

capacity (plunger near out) for maximum indication. Tighten lock nut. Slowly pull out plunger of antenna air trimmer C5 until maximum (peak) amplitude of output is reached while slightly rocking the gang tuning condenser back and forth through the signal. Two peaks may be found with this circuit. The peak with maximum capacity (plunger near in) should be used. Tighten lock nut.

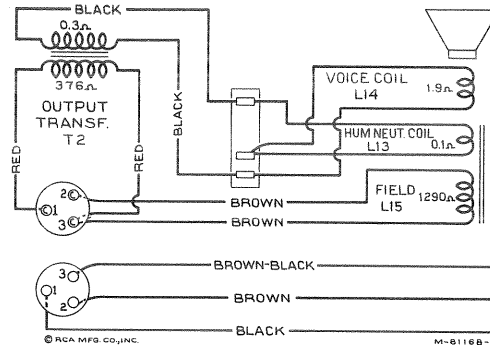

Figure 5—Loudspeaker Wiring

#### "Medium Wave" Band

- (k) Place receiver range selector to its "Medium wave" position with the receiver dial pointer set to 6,000 kc. Tune the test oscillator to 6,000 kc. Carefully adjust the oscillator and antenna air trimmers C14 and C6 respectively, so that each brings about maximum (peak) amplitude of output as shown by the wave on the oscillograph. When adjusting the oscillator trimmer C14, two peaks may be found. The one of minimum capacitance (plunger near out) should be used. Tighten lock nuts.

#### "Wave-Trap" Adjustment

- (l) Connect the output of the test oscillator to the antenna terminal "A1" through a 200 mmfd. (important) capacitor. Place receiver range selector in "Standard broadcast" position. Set the receiver dial to a position of no extraneous signals near 600 kc. Tune the test oscillator to 460 kc. Adjust the wave-trap magnetite core screw to the point which causes minimum amplitude of output (maximum suppression of signal) as shown by the wave on the oscillograph. An increase of the test-oscillator output may be necessary before this point of minimum amplitude, obtained by correct adjustment of wave-trap screw, becomes apparent on oscillograph screen.

#### "Standard Broadcast" Band

- (m) Reduce output of test oscillator to minimum. Set receiver dial pointer to 600 kc. Tune the test oscillator to 600 kc and increase its output until a deflection is noticeable on the oscillograph screen.
- (n) Adjust oscillator magnetite core screw (top of oscillator coil) so that maximum (peak) amplitude of output is shown on the oscillograph screen.



- (o) Set receiver dial pointer to 1,500 kc. Set the test oscillator to 1,500 kc (1,500-3,100-kc range) and increase its output to produce a registration on the oscillograph. Carefully adjust the oscillator and antenna air trimmers C16 and C7 respectively so that each brings about maximum (peak) amplitude of output as shown by the waves on the oscillograph. Shift the oscillograph "Timing" switch to "Ext." Place the frequency modulator sweep-range switch to "Lo" position and insert plug of the frequency modulator cable in test oscillator jack. Turn test oscillator modulation switch to "Off." Retune the test oscillator (increase frequency) until the forward and reverse waves show on the oscillograph screen. This will occur at a test oscillator setting of **approximately 1,680 kc.** Adjust the trimmers C16 and C7 again, setting each to the point which produces the best coincidence and maximum amplitude of the images.
- (p) Remove the plug of the frequency modulator cable from test oscillator jack. Turn test oscillator modulation switch to "On." Set oscillograph "Timing" switch to "Int." Tune test oscillator to 200 kc. (200-400-kc range). Tune receiver for maximum response to this signal at a dial reading of **approximately 600 kc.** Third harmonic

of 200 kc is used for this adjustment. Shift oscillograph "Timing" switch to "Ext." Insert the plug of the frequency modulator cable in test oscillator jack. Turn test oscillator modulation switch to "Off." Retune the test oscillator (increase frequency) until the forward and reverse waves show on the oscillograph screen. This will occur at a test oscillator setting of **approximately 230 kc.** Disregarding the fact that the two images may come together, adjust the oscillator magnetite core screw (top of oscillator coil) to produce maximum amplitude of images. Shift oscillograph "Timing" switch to "Int." Remove the plug of the frequency modulator cable from the test oscillator. Turn test oscillator modulation switch to "On." Repeat adjustment (o), and then lock C16 and C7.

### Output Indicator Alignment

Attach the output indicator across the loudspeaker voice-coil circuit. Advance the receiver volume control to its maximum position, letting it remain in such position for all adjustments. For each adjusting operation, regulate the test oscillator output so that the signal level is as low as possible and still be observable at the receiver output. Use of such small signal will obviate broadness of tuning which would otherwise result from a.v.c. action on a stronger one.

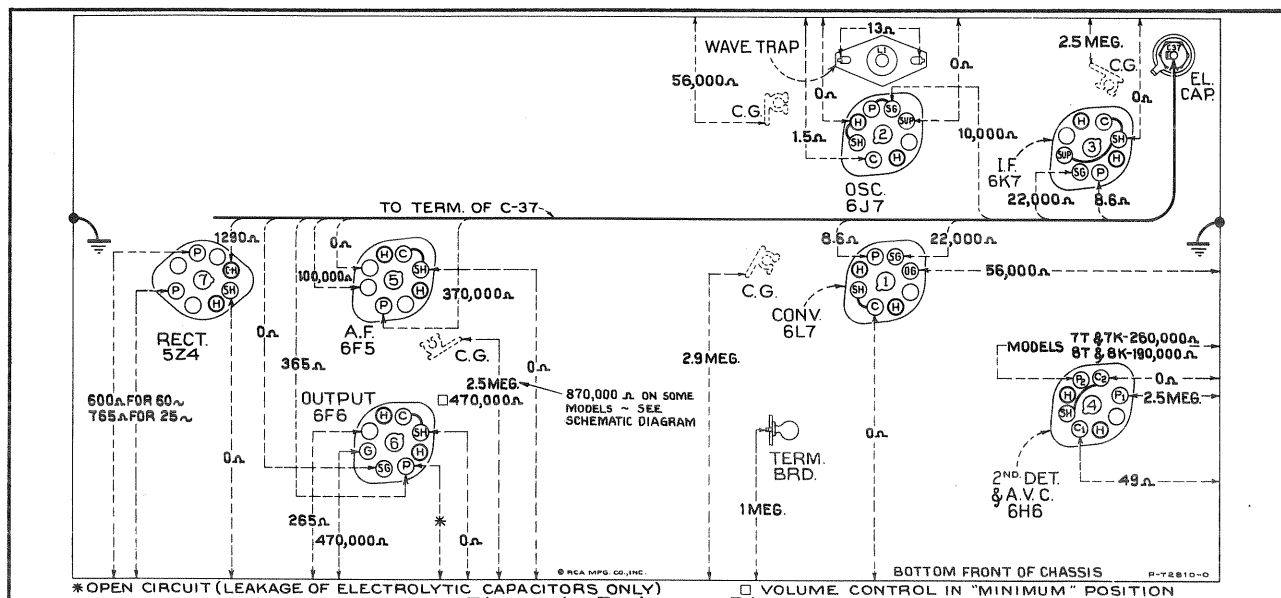

Figure 6—Resistance Diagram

Power supply disconnected—Radiotrons in sockets—Tuning condenser in full-mesh—  
Range selector in "Standard broadcast" position—Volume control maximum

### Resistance Measurements

The resistance values shown between Radiotron socket contacts, grid caps, resistors, and terminals to receiver chassis ground or other pertinent point on figure 6, permit a rapid continuity check of the circuits. The use of this diagram in conjunction with the Schematic Circuit Diagram, figure 1, and Chassis Wiring Diagram, figure 2, will permit the location of certain troubles which might otherwise be difficult to ascertain. Each value as specified should hold within  $\pm 20\%$ . Variations in excess of this limit will usually be indicative of trouble in circuit under test. Resistance values were measured with the

Radiotrons in sockets, range selector in "Standard broadcast" position, tuning condenser in full mesh, and volume control set at maximum unless otherwise noted. In all cases of measuring the resistance between points of the circuit and ground, it will be necessary to connect the negative terminal of the resistance meter to chassis-ground. If the polarity of the resistance meter is not known, it may be readily ascertained by connecting a d-c voltmeter of indicated polarity across the terminals of the device.

## I-F Adjustments

- Connect the "Ant." output of the test oscillator to the grid cap of the RCA-6L7 (with grid lead in place) through a .001-mfd. capacitor, with "Gnd." to receiver chassis. Tune the test oscillator to 460 kc, place its modulation switch to "On" and its output switch to "Hi."
- Adjust the two magnetite core screws of the second i-f transformer (one on top and one on bottom), to produce maximum (peak) output.
- The two first i-f transformer magnetite core screws (one on top and one on bottom) should be adjusted to produce maximum (peak) output. It is advisable to repeat the adjustment of all i-f magnetite core screws to assure that the interaction between them has not disturbed the original adjustments.

## R-F Adjustments

Calibrate the pointer of the tuning dial by adjusting it to the extreme low-frequency end of dial scale (beyond 55 on dial) with the plates of the gang tuning condenser in full mesh. Alignment must be made in sequence of "Short wave" band, "Medium wave" band, "Wave-trap", and "Standard broadcast" band.

## "Short Wave" Band

- Connect the "Ant." output of the test oscillator to the antenna terminal "A1" through a 300-ohm resistor, leaving the "Gnd." of the oscillator connected to the receiver chassis.
- Place range selector to its "Short wave" position. Set receiver dial pointer to 20,000 kc. Adjust test oscillator to 20,000 kc. Set oscillator air trimmer C13 to minimum capacity (plunger full out), and antenna air trimmer C5 to maximum capacity (plunger full in). Slowly push in oscillator trimmer C13 until maximum (peak) output is reached. Two peaks may be found. Adjust C13 to the peak with minimum capacity (plunger near out) for maximum indication. Tighten lock nut. Slowly pull out plunger of antenna air trimmer C5 until maximum (peak) output is reached while slightly rocking the gang tuning condenser back and forth through the signal. Two peaks may be found with this circuit. The peak with maximum capacity (plunger near in) should be used. Tighten lock nut.

## "Medium Wave" Band

- Place the receiver range selector to its "Medium

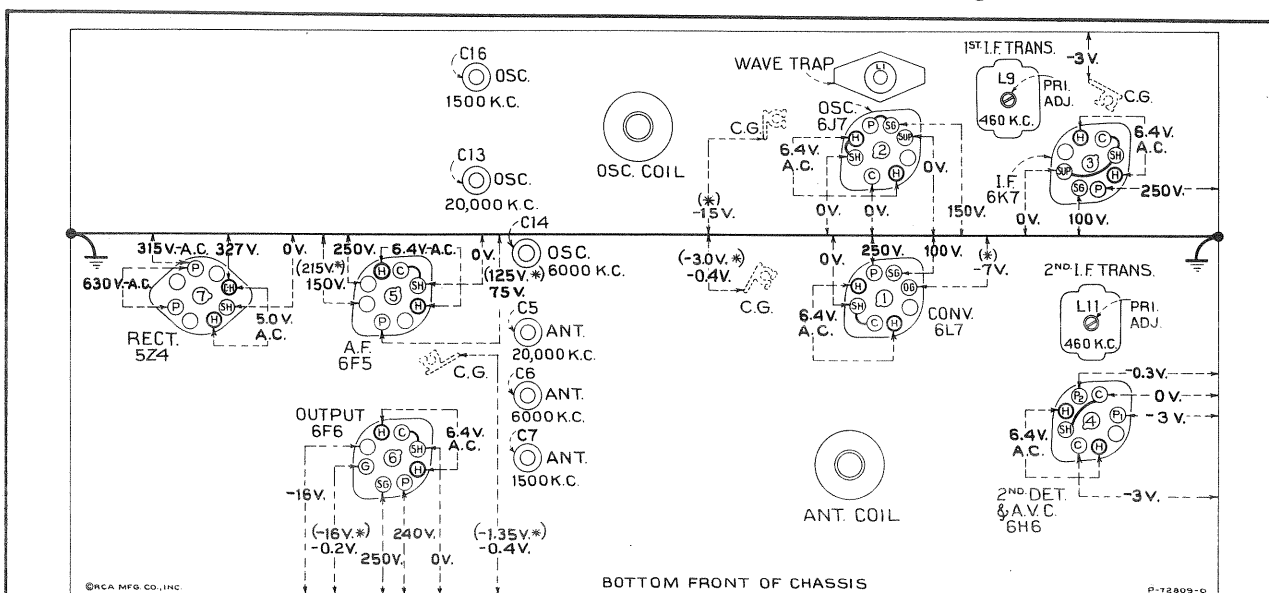

Figure 7—Radiotron Socket Voltages, Coil, and Trimmer Locations

Measured at 115 volts, 60-cycle supply—Tuned to approximately 1,000 kc—No signal being received—Volume control minimum

## Radiotron Socket Voltages

**Note:** Two voltage values are shown for some readings. The higher value shown in parenthesis with asterisk (\*) indicates operating conditions without voltmeter loading. The lower value is the actual measured voltage and differs from the higher value because of the additional loading of the voltmeter through the high series circuit resistance.

The voltage values indicated from the Radiotron socket contacts, grid caps, resistors, and terminals to receiver chassis ground on figure 7 will assist in locating cause for

faulty operation. Each value as specified should hold within  $\pm 20\%$  when the receiver is normally operative at its rated line voltage. Variations in excess of this limit will usually be indicative of trouble in the basic circuits. These voltages were measured with receiver tuned to approximately 1,000 kc, no signal being received and volume control set at maximum. To duplicate the conditions under which the voltages were measured requires a 1,000-ohm-per-volt d-c meter, having ranges of 10, 50, 250, 500, and 1,000 volts. Use the nearest range above the voltage to be measured. A-c voltages were measured with a corresponding a-c meter.



wave" position, with the receiver dial pointer set to 6,000 kc. Tune test oscillator to 6,000 kc. Carefully adjust the oscillator and antenna air trimmers C14 and C6 respectively, so that each brings about maximum (peak) output. When adjusting the oscillator trimmer C14, two peaks may be found. The one of minimum capacitance (plunger near out) should be used.

### "Wave-Trap" Adjustment

(g) Connect the "Ant." output of the test oscillator to the antenna terminal "A1" through a 200 mmfd. (important) capacitor. Place the range selector to its "Standard broadcast" position and set the receiver dial pointer to a position of no extraneous signals near 600 kc. Tune the test oscillator to 460 kc. Adjust the wave-trap magnetite core screw to the point which causes minimum output (maximum suppression of signal). An increase of the test-oscillator output may be necessary before the point of minimum output, obtained by adjustment of wave-trap screw, becomes apparent on the output indicator.

### "Standard Broadcast" Band

- (h) Reduce output of test oscillator to a minimum. Tune the test oscillator to 600 kc and set receiver dial pointer to 600 kc. Adjust output of test oscillator until a slight indication of output is visible.
- (i) Adjust the oscillator magnetite core screw (top of oscillator coil) so that maximum (peak) output results.
- (j) Set receiver dial pointer to 1,500 kc. Tune the test oscillator to 1,500 kc. Carefully adjust the oscillator and antenna air trimmers C16 and C7 respectively so that each brings about maximum (peak) output.
- (k) Tune the test oscillator to 600 kc. Tune the receiver to pick up this signal disregarding the dial reading at which it is best received. Adjust oscillator magnetite core screw (top of oscillator coil) for maximum (peak) output while rocking

gang tuning condenser. After completing this adjustment, the trimmers C16 and C7 should be re-adjusted as in (j) to correct for any change in the oscillator high-frequency tuning which has been caused by the preceding adjustment.

## Antenna and Ground Terminals

These receivers are equipped with an antenna-ground terminal board having three terminals. These terminals are marked "A2," "A1," and "G," the latter being the ground terminal and should always be connected to a good external ground. The transmission

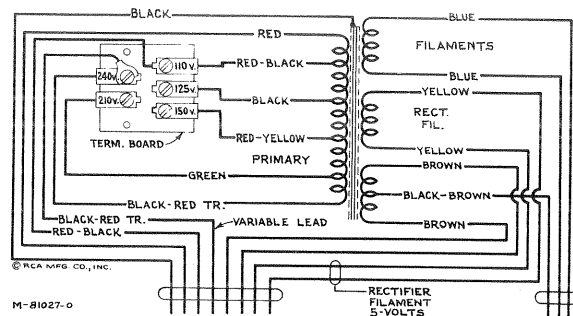

Primary resistance—24.5 ohms total  
Secondary resistance—668 ohms total

Figure 8—Universal Transformer

line leads of the RCA RK-40A antenna system should be connected to terminals "A2" and "A1." The receiver coupling units of the RCA RK-40 and the RCA Spider-Web antenna systems should be connected to terminals "A1" and "G." Connect a single-wire antenna to terminal "A1."

## Phonograph Terminal Board

A terminal board is provided for connecting a phonograph into the audio amplifying circuit. Typical methods of connecting a low-impedance pickup, or the RCA Victor Models R-93, R-93-2, and R-93-S Record Players are shown on the Schematic Diagram (figure 1).

# REPLACEMENT PARTS

Insist on genuine factory tested parts, which are readily identified and may be purchased from authorized dealers.

STOCK No.	DESCRIPTION	LIST PRICE	STOCK No.	DESCRIPTION	LIST PRICE
<b>RECEIVER ASSEMBLIES</b>					
12706	Arm—Hub and arm complete for operating shutter (located on range switch shaft) .....	.22	12714	Capacitor—Adjustable capacitor (C5, C6, C7, C13, C14, C16) .....	.38
12716	Board—Antenna and ground terminal board .....	.20	12722	Capacitor—18 Mmfd. (C15) .....	.20
12717	Board—Phonograph terminal board .....	.22	12723	Capacitor—56 Mmfd. (C9) .....	.20
5237	Bushing—Variable capacitor mounting bushing assembly—Package of 3 .....	.43	12726	Capacitor—56 Mmfd. (C2) .....	.20
12730	Cable—Shielded cable approximately 14½ in. long—volume control to phono terminal board .....	.40	12724	Capacitor—120 Mmfd. (C18, C32) .....	.28
11625	Cable—Tuning tube cable and socket complete (Models 8T and 8K) .....	1.26	12404	Capacitor—120 Mmfd. (C20, C22, C23, C24) .....	.26
12511	Cap—Grid contact cap—Package of 5 .....	.15	12725	Capacitor—150 Mmfd. (C1) .....	.28
			12406	Capacitor—180 Mmfd. (C25) .....	.26
			12727	Capacitor—555 Mmfd. (C12) .....	.20
			12537	Capacitor—560 Mmfd. (C3) .....	.20
			12729	Capacitor—1,550 Mmfd. (C11) .....	.26
			12728	Capacitor—4,500 Mmfd. (C10) .....	.36
			4868	Capacitor—.005 Mfd. (C19, C35) .....	.20
			4858	Capacitor—.01 Mfd. (C26, C27, C31) ..	.25

Prices quoted above are subject to change without notice.

## REPLACEMENT PARTS—Continued

Stock No.	DESCRIPTION	LIST PRICE	STOCK No.	DESCRIPTION	LIST PRICE
11315	Capacitor—.015 Mfd. (C33).....	.20	11195	Socket—5-contact 5Z4 radiotron socket..	.15
12670	Capacitor—.035 Mfd. (C34).....	.20	11198	Socket—7-contact 6J7, 6K7 or 6L7 radio-	
4836	Capacitor—.05 Mfd. (C40) (Models 8T			tron socket.....	.15
	and 8K).....	.30	11196	Socket—8-contact 6F5, 6F6, 6H6, radio-	
4841	Capacitor—.01 Mfd. (C29).....	.22		tron socket.....	.15
11414	Capacitor—.01 Mfd. (C30).....	.20	11222	Socket—Dial lamp socket.....	.18
4840	Capacitor—.025 Mfd. (C28).....	.30	11381	Socket—Tuning tube socket and cover	
5170	Capacitor—.025 Mfd. (C8, C21).....	.25		(Models 8T and 8K).....	.45
11240	Capacitor—.10 Mfd. (C36).....	1.08	12007	Spring—Retaining spring for core Stock	
5212	Capacitor—.18 Mfd. (C37).....	1.16		No. 12006, 12664 and 12711—Package	
12708	Coil—Antenna coil and shield (L2, L3,			of 10.....	.36
	L4, L5).....	2.04	12849	Spring—Tension spring for band indicator	
12709	Coil—Oscillator coil and shield (L6, L7,			shutter link—Package of 5.....	.18
	L8).....	2.02	12707	Switch—Range switch (S1, S2).....	1.64
12701	Condenser—2-gang variable tuning con-		12668	Tone Control—Control and operating	
	denser (C4, C17).....	4.00		switch (R16, S3).....	1.22
5119	Connector—3-contact female connector for		12652	Transformer—First I.F. transformer com-	
	speaker cable.....	.25		plete (L9, L10, C20, C22).....	1.60
12711	Core—Adjustable core and stud for Stock		11999	Transformer—Power transformer 105-125	
	No. 12709.....	.16		volts, 60 cycle (T1).....	3.80
12006	Core—Adjustable core and stud for Stock		12132	Transformer—Power transformer 105-125	
	No. 12652 and 12653.....	.22		volts, 25 cycle (T1).....	5.48
12664	Core—Adjustable core and stud for Stock		12133	Transformer—Power transformer 100-250	
	No. 12654.....	.22		volts, 60 cycle (T1).....	6.25
12703	Dial—Station selector dial scale.....	.80	12653	Transformer—Second I.F. transformer	
12702	Drive—Vernier drive for tuning capacitor	.68		complete (L11, L12, C23, C24, C25,	
12712	Indicator—Station selector indicator			R8, R9).....	2.06
	pointer.....	.22	12654	Trap—Wave trap complete (L1).....	.75
5226	Lamp—Indicator dial lamp 6.3 volt—		13144	Volume Control (R11).....	1.00
	Package of 5.....	.70			
12718	Mask—Dial light diffuser complete with			REPRODUCER ASSEMBLIES	
	red, orange and green colored screen..	.40	12641	Board—Reproducer terminal board.....	.15
12738	Resistor—27,000 ohms, insulated, 1/4 watt		12640	Bracket—Output transformer mounting	
	—Package of 5 (R10).....	1.00		bracket.....	.18
11282	Resistor—56,000 ohm, carbon type 1/10		12012	Coil—Field coil (L15).....	1.85
	watt—Package of 5 (R8).....	.75	11469	Coil—Neutralizing coil (L13).....	.20
12286	Resistor—56,000 ohm, carbon type, 1/4		12642	Cone—Reproducer cone and dust cap	
	watt—Package of 5 (R2).....	1.00		(L14) (Models 7T and 8T).....	.94
11282	Resistor—56,000 ohm, carbon type, 1/10		12667	Cone—Reproducer cone and dust cap	
	watt—Package of 5 (R4).....	.75		(L14) (Models 7K and 8K).....	1.00
11281	Resistor—100,000 ohm, carbon type, 1/10		5118	Connector—3-contact male connector for	
	watt—Package of 5 (R13).....	.75		speaker cable.....	.25
11398	Resistor—220,000 ohm, carbon type, 1/10		12666	Cover—Speaker cover (Models 7K and	
	watt—Package of 5 (R9).....	.75		8K).....	.65
11453	Resistor—270,000 ohm, carbon type, 1/10		9696	Reproducer Complete—(Models 7K and	
	watt—Package of 5 (R14).....	.75		8K).....	6.90
11452	Resistor—470,000 ohm, carbon type, 1/10		9699	Reproducer Complete—(Models 7T and	
	watt—Package of 5 (R1, R15).....	.75		8T).....	6.38
12285	Resistor—470,000 ohm, insulated, 1/4 watt		11253	Transformer—Output transformer (T2)..	1.56
	—Package of 5 (R12).....	1.00	11886	Washer—Spring washer to hold field coil	
12013	Resistor—1 meg., carbon type, 1/10 watt			securely—Package of 5.....	.20
	—Package of 5 (R22) (Models 8T and				
	8K).....	.75		MISCELLANEOUS ASSEMBLIES	
11626	Resistor—2.2 meg., carbon type, 1/4 watt		11996	Bracket—Tuning tube mounting bracket	
	—Package of 5 (R7, R20, R21).....	1.00		(Models 8T and 8K).....	.22
12004	Resistor—Voltage divider comprising one		12698	Crystal—Station selector crystal and escut-	
	216 ohm, one 27 ohm and one 22 ohm			cheon.....	1.02
	sections (R17, R18, R19).....	.45	12742	Escutcheon—Tuning tube escutcheon	
12715	Resistor—Wire wound comprising one			(Models 8T and 8K).....	.22
	22,000 ohm and one 10,000 ohm		12699	Knob—Large tuning knob—Package of 5	.68
	sections (R3, R6).....	.86	11582	Knob—Tone control knob—Package of 5	.50
4669	Screw—No. 8-32 set screw for arm Stock		12700	Knob—Vernier tuning knob (small)—	
	No. 12706—Package of 10.....	.25		Package of 5.....	.58
12651	Shield—Coil shield for Stock No. 12708	.22	11347	Knob—Volume control or range switch	
12710	Shield—Coil shield for Stock No. 12709	.28		knob—Package of 5.....	.75
12735	Shield—Dial lamp shield—Package of 5.	.25	11377	Screw—Chassis mounting screw assembly	
12008	Shield—I.F. transformer shield for Stock			for Table Model—Package of 4.....	.12
	No. 12652 and 12653.....	.28	11210	Screw—Chassis mounting screw assembly	
12581	Shield—Shield top for I.F. transformer			for Console Model—Package of 4....	.28
	Stock No. 12653.....	.36	4982	Spring—Retaining spring for knob Stock	
12607	Shield—Shield top for I.F. transformer			No. 12699—Package of 10.....	.50
	Stock No. 12652.....	.30	11349	Spring—Retaining spring for knob Stock	
12704	Shutter—Dial scale holder and shutter as-	.88		No. 11347, 11582 and 12700—Pack-	.25
	sembly for band indicator.....			age of 5.....	

First Edition

Prices quoted above are subject to change without notice.